

DOT/FAA/CT-95/46

# Fire Calorimetry

FAA Technical Center  
Atlantic City International Airport,  
N.J. 08405



This document is available to the public  
through the National Technical Information  
Service, Springfield, Virginia 22161



U.S. Department of Transportation  
Federal Aviation Administration

1. Report No. DOT/FAA/CT-95/46		2. Government Accession No.		3. Recipient's Catalog No.	
4. Title and Subtitle FIRE CALORIMETRY				5. Report Date July 1995	
				6. Performing Organization Code	
7. Author(s) Richard E. Lyon				8. Performing Organization Report No. DOT/FAA/CT-95/46	
9. Performing Organization Name and Address Federal Aviation Administration Technical Center Atlantic City International Airport, NJ 08405				10. Work Unit No. (TRAIS)	
				11. Contract or Grant No.	
12. Sponsoring Agency Name and Address Interagency Working Group on Fire and Materials (IWGFM) and the Federal Aviation Administration Technical Center				13. Type of Report and Period Covered Proceedings July 27-28, 1995	
				14. Sponsoring Agency Code AAR-423	
15. Supplementary Notes The IWGFM consists of members from NASA, NTSB, and the Departments of Transportation (FAA, USCG, NHTSA, FTA), Commerce (NIST), Defense (U.S. Army, U.S. Navy, U.S. Air Force, Defense Nuclear Agency), Interior (U.S. Bureau of Mines), Agriculture (Forest Products Laboratory), Energy (Lawrence Livermore National Lab, Sandia National Lab) and is dedicated to improving human survivability and protecting property in fires.					
16. Abstract This report is a compilation of papers presented at a special symposium on Fire Calorimetry held at NIST, Gaithersburg, MD, on July 27-28, 1995. It includes papers on the theory, instrumentation, and use of fire (or heat release) calorimetry in assessing the fire hazard of materials.					
17. Key Words Fire, Fire hazard, Flammability, Heat release, Fire calorimetry, Fire model, Fire resistant materials, Polymers, Plastics, Heat release calorimeter, Cone calorimeter, Oxygen consumption, Smoke			18. Distribution Statement Document is available to the public through the National Technical Information Service, Springfield, Virginia 22161		
19. Security Classif. (of this report) Unclassified		20. Security Classif. (of this page) Unclassified		21. No. of Pages 204	22. Price

---

---

# **FIRE CALORIMETRY**

---

---

**Edited by:**

**Marcelo M. Hirschler**

**and**

**Richard E. Lyon**

**July 1995**

# FIRE CALORIMETRY

July 27-28, 1995

Gaithersburg, MD

## Contents:

	Pages
Marcelo Hirschler (GBH International) <i>Introduction</i>	7-8
John Lyons (US Army Research Laboratory) <i>Fire Science and Engineering - Why so hard?</i>	9
Richard G. Gann (National Institute of Standards & Technology) <i>Fire Calorimetry Science</i>	10
Marc Janssens (American Forest & Paper Association) <i>Methods and Equations of Fire Calorimetry</i>	11-22
Edwin E. Smith (Ohio State University) <i>Heat Release Rate Calorimetry</i>	23-32
Vytenis Babrauskas (Fire Science and Technology) <i>Oxygen Consumption Calorimetry: ASTM and ISO Apparatuses</i>	33-44
Archibald Tewarson (Factory Mutual Research Corporation) <i>Calorimetry and Fire Environment</i>	45-47
Takashi Kashiwagi (National Institute of Standards & Technology) <i>Fire Calorimetry and Materials Research</i>	48-49
Arthur F. Grand (Omega Point Laboratories) <i>The Influence of Fire Calorimetry Results on Product Research and Development Activities"</i>	50-57
Bjorn Karlsson (University of Lund, Sweden) <i>Modelling Fire Growth Using Calorimetry Bench-Scale Data</i>	58-67

Jeffrey Newman (Factory Mutual Research Corporation) <i>Fire Suppression and Extinguishment Calorimetry</i>	68
Marcelo M. Hirschler (GBH International) <i>Use of Heat Release Calorimetry in Standards</i>	69-80
Richard W. Bukowski (National Institute of Standards & Technology) <i>On the Central Role of Fire Calorimetry in Modern Fire Hazard Assessment</i>	81
Richard D. Peacock, Richard W. Bukowski (National Institute of Standards & Technology) and Vytenis Babrauskas (Fire, Science & Technology) <i>Defining Flashover for Fire Hazard Calculations</i>	82-91
Ned Keltner (K-Tech Corporation) <i>Thermal Measurements in Fire Safety Testing - Are We Playing with Fire?</i>	92-100
Thomas Gracik and George L. Long (Naval Surface Warfare Center) <i>Heat Release and Flammability of a Small Specimen Using Thermoanalytical Techniques</i>	101
Thomas Gracik, George L. Long, Usman A.K. Sorathia (Naval Surface Warfare Center) and Henry E. Douglas (Univ. Washington) <i>A Novel Thermogravimetric Technique for Determining Flammability Characteristics of Polymeric Materials</i>	102-111
Louis A. Gritzo, Jaime L. Moya, Douglas Murray and Edward Muzio (Sandia National Laboratories) <i>Characterization of Incident Heat Fluxes and Object Thermal Response in Large Hydrocarbon Pool Fires</i>	112
David C. Morrison (Advanced Systems Technology) and Richard C. Corlett (Univ. Washington) <i>Fire Gas Characterization via Potential Oxygen Consumption Calorimetry</i>	113-121
James Quintiere (University of Maryland) <i>Use and Interpretation of Calorimetry Data for Fire Predictions</i>	122-133
Craig L. Beyler, Jesse Beitel, N. Iqbal, D Gottuk, M. Peatross (Hughes Associates) and Fred W. Williams (Naval Research Laboratory) <i>Fire Growth Analysis Using Fire Calorimetry</i>	134
Michael J. Spearpoint and Martin P. Shipp (Fire Research Station, UK) <i>Measurement of Heat Release Rate from Burning Automobiles for Channel Tunnel Hazard Assessment</i>	135-147

Michael A. Delichatsios (Factory Mutual Research Corporation) <i>Flammability Properties for Polymeric (Plastic) Materials: An Engineering and Scientific Approach</i>	148-152
David C. Noll and Usman Sorathia (Naval Surface Warfare Center) <i>Correlation Between Quarter-Scale Flashover Fire Tests and Cone Calorimeter Heat Release Rates</i>	153
Robert Buch (Dow Corning Corporation) <i>Cone Calorimeter Applications in Fire Resistant Materials Characterization and Development</i>	154-156
Giovanni Gallina, E. Bravin, C. Badalucco (CNR, Milan, Italy), G. Audisio, M. Armanini, A. De Chirico and F. Provasoli (ICM, CNR, Milan, Italy) <i>Application of Cone Calorimeter for the Assessment of Class of Flame Retardants for Polypropylene</i>	157-171
James E. McGrath (Virginia Polytechnic Institute & State University) <i>Synthesis of High Performance Phosphine Oxide Thermoplastics</i>	172
Constantine P. Sarkos, Richard G. Hill and Richard M. Johnson (Federal Aviation Administration) <i>Implementation of Heat Release Measurements as a Regulatory Requirement for Commercial Aircraft Materials</i>	173-184
Fred E. Arnold, Jr., J. Rodriguez-Arnold, A.M. Granville and Richard E. Lyon (Federal Aviation Administration) <i>Combustion Behavior of Phenolic Triazine Resins</i>	185-194
Richard E. Lyon (Federal Aviation Administration) <i>Material Properties and Heat Release Rate of Polymers</i>	195-204

# INTRODUCTION

Marcelo M. Hirschler

GBH International

38 Oak Road

Rocky River, OH, 44116-1640, USA

This book is a result of an idea by Richard Lyon to let the world of calorimetry users know about the importance and applications of the technique of calorimetry, as it is being applied in the field of fire testing and fire research.

The conference consists of 27 presentations, of which a dozen were invited, in view of the known background of the author, and with the objective of covering, as broadly as possible, the whole subject. Thus, Dr. John Lyons puts the issue of Fire Science and Engineering in a general background, while introducing the subject of fire calorimetry (or heat release, as it is known in the fire community). Dr. Richard Gann deals with the basic science associated with fire calorimetry, in particular explaining the chemical and physical reasons why heat release is such an important property in order to quantify the magnitude of a fire and the distinction between heat release and complete heat of combustion, of little relevance to fire hazard. Dr. Marc Janssens explains the mathematical background of the measurement of heat release via several methods: principally temperature rise (thermopile) and oxygen consumption. Dr. Edwin Smith focusses his presentation on the use of an instrument, which has come to be known as the Ohio State University rate of heat release calorimeter, based on thermopile measurements, and which is being extensively used for regulatory purposes. In contrast, Dr. Vytenis Babrauskas will focus on oxygen consumption calorimetry, especially the cone calorimeter, which is now the premier research instrument for small scale testing, as well as intermediate and full scale tests. Dr. Archibald Tewarson describes another type of fire calorimetry, where measurements are made based on generation of carbon oxides, and where the heat evolved by chemical reaction is characterized in terms of its convective and radiative fractions. Dr. Takashi Kashiwagi explains that the technique of fire calorimetry can be used to develop new materials, with different chemical properties, one of the most important of which, from the point of view of markers of fire performance, is the capacity to generate char on burning. Dr. Arthur Grand describes the way in which industrial sponsors use the techniques inherent in fire calorimetry to develop new products, which introduce greater fire safety to the consumer. Dr. Björn Karlsson (University of Lund, Sweden) explains how the results of cone calorimetric tests can be used to predict, both qualitatively and quantitatively, whether a material or product is likely to result in uncontained flame spread (or flashover) in the environment of a small room, by means of a zone fire model. Dr. Jeffrey Newman will explain the use of calorimetric techniques to understand the phenomenon of fire suppression and to determine the effectiveness of different suppressions systems. Dr. Marcelo Hirschler

conducts a survey of the ca. 30 standards in existence, within the United States and as international standards, which address the issue of fire calorimetry: they range between those that use fairly small samples (like the cone calorimeter) to some that use very large samples (lining the entire walls and ceiling of a room), as well as guides that explain the importance of heat release in fires and describe how such measurements should be made. The final invited presentation, from Richard Bukowski, takes this concept a step further and shows how heat release is essential for the development of hazard assessments. The article attached addresses one specific aspect of hazard assessment: the estimation of flashover in a compartment.

The submitted presentations cover a broad gamut of specific issues. Dr. Ned Keltner addresses some of the pitfalls inherent in thermal measurements, which can end up, unless care is taken, in measurements themselves introducing output errors. Thomas Gracik shows how a thermoanalytical technique, with milligram size samples, can give useful information and properties associated with heat release in traditional test specimens. One of the most important issues to be addressed when determining heat release is the heat flux for the input to the sample: that issue is being addressed by Louis Gritzko. David Morrison describes characterization of fire gases, with the emphasis on incomplete combustion products, by a new technique using a specialized reactor, and oxygen consumption calorimetry. Dr. James Quintiere and Dr. Craig Beyler are involved, separately, in the development of models that can be used to predict flame spread in fires and fire growth from cone calorimeter data. Michael Spearpoint presents information on a unique project, where full scale cars were burned in tests designed to understand the potential hazard associated with carrying cars on trains through the tunnel between England and France under the English Channel. Dr. Michael Delichatsios developed a theoretical flammability properties model, which he is applying to fundamental characteristics of polymeric materials to assess their fire performance; such properties include heat release techniques as well as flame spread and smoke development. Usman Sorathia is interested in correlating the results of fire tests in a small room (the one quarter scale flashover compartment), used to approve and characterize materials for naval applications, with results of small scale test equipment, with the emphasis on fire calorimetry. Robert Buch uses the cone calorimeter to assess the fire properties of fire resistant materials, particularly silicones, and to develop applications for them as well as an understanding of their breakdown mechanism. Dr. Giovanni Gallina uses the cone calorimeter to assess the effectiveness of classes of fire retardant packages on polypropylene, a widely used polymer, as part of a large study investigating potential alternative additives for this thermoplastic material. Dr. James McGrath is developing new thermoplastic materials based on phosphine oxide, with high fire performance and potential application in the aviation industry. Constantine Sarkos explains how the heat release testing technique was developed, following extensive research at the Federal Aviation Administration, into a regulatory tool, forcing manufacturers into advanced material development. Dr. Frank Arnold is also developing new materials with improved fire performance, potentially for aviation applications, but these are based on phenolic triazine resins. Finally, Dr. Richard Lyon investigates theoretical ways of predicting heat release of polymers based on their fundamental properties and simple measurements.



## FIRE SCIENCE AND ENGINEERING - WHY SO HARD?

John W. Lyons

Army Research Laboratory  
2800 Powder Mill Road  
Adelphi, MD 20783-1197

The use of calorimetry to get at some of the difficulties in measuring and predicting the behavior of materials in fire is making progress in bringing scientific rigor to the problem. Determining which characteristics of materials to measure is only one part of a broader problem. It is crucial to make the right measurements on materials; we also have to know how the materials behave when assembled into products - chairs, rugs, wall coverings, etc. And equally important, we have to know how products behave when arrayed in an occupancy such as a bedroom, living room, health care facility, or schoolroom. We want to know how a fire develops given an ignition sequence. This will be different for ignitions in different places. What is important is the rate of fire build-up in terms of heat and combustion products. These rates determine the spatial development of the fire and the hazard to occupants in the room of origin and in adjacent spaces.

The old way of gaining answers to these questions was to build a replica of the occupancy in question, furnish it with the items in the configuration most likely to occur, ignite the set-up with a likely ignition sequence, and measure the growth and spread of the resulting fire. This build-it-and-burn-it approach to fire testing was (and is) not only very expensive and time consuming but also inefficient in that it provides answers to one and only one set of conditions. It doesn't answer the question: what if we change one item in the scenario? Only another expensive full-scale fire test can do that. And so fire researchers have been seeking a better approach. Such an approach involves the following components: fire behavior of materials, influence of geometry of materials assembled in products, and models of fire growth and spread in a room or a series of rooms. As computing power and sophistication of the software have grown it has become possible to model fire growth and spread to at least an engineering level of accuracy. To do this requires knowing the heat content and rate of its release under given exposure conditions. Hence the interest in heat release calorimetry. We have done this at both small and large scale, as will no doubt be described in the several talks at this meeting. We do similar measurements of the release rate of combustion products. With the two results we should be able to provide part of the required input to the computer models of room fires.

However, we are left with various challenges in the modeling activity, challenges that are very difficult to overcome. Some of these relate to the complexity of the modeling - turbulent flows, lack of any symmetry, large number of possible combinations of events, and the like - and some relate to the difficulty of making measurements in the real fire tests because of the "dirty" environment. This meeting will help us focus on these issues and to move ahead in addressing the fire problem.

## THE SCIENCE OF FIRE CALORIMETRY

Richard G. Gann

Fire Science Division

Building and Fire Research Laboratory

National Institute of Standards and Technology

Gaithersburg, MD 20899

USA

There are several reasons for wanting to quantify the “strength” of a fire, including: describing (or prescribing) the acceptable performance of a potentially flammable component, such as a chair, wall material, or clothing item; knowing the magnitude of the threat that needs to be controlled by containment or suppression measures; and calculating the growth rate of fire hazard in order to predict the time available for people to escape. At the core of each of these is numerical presentation of two of the key flammability properties: heat or enthalpy release and its time derivative or rate.

Many descriptions of fires are far from quantitative or scientific, yet they serve useful purposes. For example, in today’s standard fire incident reports, fires are still characterized by an extent of growth, such as “within the room of fire origin” or within the floor of fire origin.” As our ability and need to describe fires more precisely grows, so too does our need for appropriate measurements.

Initially, the classical temperature rise principle was used to determine the total possible heat release, the heat of combustion, although it was realized that this was often a quite high upper limit to the value actually developed in a fire. The science and apparatus for measuring actual heat release and the rate of heat release under varying fire conditions did not emerge until well into the 20th century. Since then, as is characteristic of many fields of measurement, the initial principles upon which these measurements were based have given way to successively better ones as the demand for higher precision and accuracy increased.

This paper reviews the history of fire calorimetric measurements and the successive chemical and physical principles upon which those measurements have been based. Parallels will be drawn to the quantification of other parameters, such as length and time.

## METHODS AND EQUATIONS OF FIRE CALORIMETRY

Marc. L. Janssens

American Forest & Paper Assoc., Suite 800  
1111 19th St., Washington, D.C. 20036

Recent studies have clearly indicated that rate of heat release is the primary variable that determines the contribution to compartment fire hazard from materials. Hence, there is a need for high quality heat release rate data, and consequently, for devices and methods to measure it accurately. This was first recognized in the early 1970's, and many laboratory-scale calorimeters have been developed since then. These calorimeters are based on one of the following four measuring techniques:

- (1) *Sensible Enthalpy Rise Method* - Heat release rate is measured on the basis of the difference in temperature between the air supplied at a constant rate to the combustion chamber, and the products of combustion.
- (2) *Substitution Method* - Heat release rate is determined from the flow s supplied to a gas burner during a second run, duplicating the temperature-time curve of the products of combustion measured for a test specimen during the first run.
- (3) *Compensation Method* - Heat release rate is determined from the reduction of the flow to a gas burner that is operated while a specimen is being tested, in order to maintain a constant exhaust temperature.
- (4) *Oxygen Consumption Method* - Heat release rate is determined from the oxygen concentration and rate of the exhaust flow. This method is based on the remarkable observation that for a large number of materials, a more or less constant amount of heat is released per mass unit of oxygen consumed for complete combustion.

Practical implementation of the four methods and the main equations are discussed in detail. Method (1) was the first to be used for fire calorimetry. Mainly because of its simplicity, it is still in use today. However, the method suffers from a number of problems that make it difficult to obtain accurate measurements. Methods (2) and (3) were developed to circumvent some of the problems associated with method (1). However, this was at the expense of greatly increased complexity of the instrumentation, primarily for control of the gas flow to the substitution or compensation burner. Method (4) was first used for fire test applications in the early 1980's. Since then, the technique has been refined, and is now used throughout the world as the preferred method for measuring heat release rate from experimental fires. The method related to (4) is based on CO<sub>2</sub> generation, instead of oxygen consumption. Although it is easier to implement, this method is not as versatile as the oxygen consumption method.

# METHODS AND EQUATIONS OF FIRE CALORIMETRY

Marc L. Janssens  
 American Forest & Paper Association  
 1111 Nineteenth Street NW, Suite 800  
 Washington, DC 20036

## Introduction

Rate of heat release is the primary variable that determines the contribution to compartment fire hazard from materials. This was clearly demonstrated by Babrauskas and Peacock in a recent sensitivity study using the NIST fire hazard assessment software Hazard I<sup>1</sup>. With compartment fire hazard assessment as the primary application, there is a need for high quality heat release rate data, and, consequently, for devices and methods to measure it accurately. Over the past 40 years numerous heat release test methods were developed, varying widely in concept and features. These methods rely on one of four measuring techniques, which form the subject of this paper. A more detailed discussion of fire calorimetry can be found in the second edition of the SFPE Handbook of Fire Protection Engineering<sup>2</sup>.

## Sensible Enthalpy Rise Method

Consider the energy balance of a gas-phase control volume enclosing the flame of a burning specimen (see Fig. 1). Air enters the control volume at a flow rate  $\dot{m}_a$  and temperature  $T_a$ . The enthalpy of this air can be written as

$$h_a = h_a^0 + c_p(T_a - T_0), \quad (1)$$

where  $h_a$  = enthalpy of air at temperature  $T_a$  ( $\text{kJ}\cdot\text{kg}^{-1}$ ),  
 $h_a^0$  = enthalpy of air at reference temperature  $T_0$  ( $\text{kJ}\cdot\text{kg}^{-1}$ ),  
 $c_p$  = average specific heat of air between  $T_0$  and  $T_a$  ( $\text{kJ}\cdot\text{kg}^{-1}\cdot\text{K}^{-1}$ ),  
 $T_a$  = temperature of the air entering the combustion zone (K), and  
 $T_0$  = reference temperature (K).

Part of the heat flux which strikes the exposed surface is conducted into the specimen. This heat flow raises the temperature of the solid, and decomposes some fraction into combustible fuel vapors. The vapors are generated at a rate  $\dot{m}_v$ , and enter the control volume at temperature  $T_v$ . Under the assumption that specific heat of all gases is approximately constant and temperature-independent (a reasonable approximation), the enthalpy of the fuel vapors can be written as

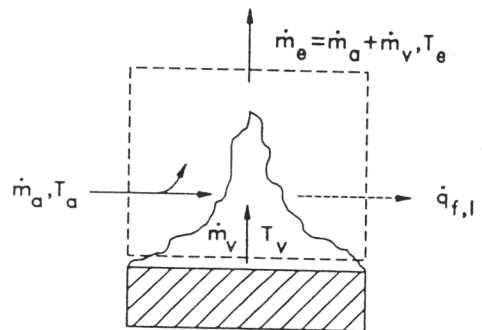


Fig. 1 Gas-phase energy balance

$$h_v = h_v^o + c_p(T_v - T_o), \quad (2)$$

where  $h_v$  = enthalpy of volatiles at temperature  $T_v$  ( $\text{kJ}\cdot\text{kg}^{-1}$ ),  
 $h_v^o$  = enthalpy of volatiles at reference temperature  $T_o$  ( $\text{kJ}\cdot\text{kg}^{-1}$ ), and  
 $T_v$  = temperature of volatiles entering the combustion zone (K).

The fuel vapors mix with air, and are converted in the flame to products of combustion. The total flow rate,  $\dot{m}_e$ , of combustion products, which includes some excess air, has a temperature  $T_e$  and enthalpy given by

$$h_e = h_e^o + c_p(T_e - T_o), \quad (3)$$

where  $h_e$  = enthalpy of combustion products at temperature  $T_e$  ( $\text{kJ}\cdot\text{kg}^{-1}$ ),  
 $h_e^o$  = enthalpy of combustion products at reference temperature  $T_o$  ( $\text{kJ}\cdot\text{kg}^{-1}$ ), and  
 $T_e$  = temperature of combustion products leaving the control volume (K).

$T_e$  is higher than the mass-weighted average of  $T_a$  and  $T_v$ , because of the heat released by combustion in the flame,  $\dot{q}$ . However, only a fraction of this heat contributes to the temperature rise of the gases. This fraction is referred to as the convective fraction of the heat release rate. The remaining fraction of  $\dot{q}$  is lost and is denoted as  $\dot{q}_{f,l}$ . For the most part,  $\dot{q}_{f,l}$  is lost in the form of thermal radiation to the walls of the apparatus (closed configuration) or to the environment (open configuration). A small part of  $\dot{q}_{f,l}$  consists of convective and radiative feedback to the fuel surface. Assuming gas phase transients can be neglected, application of the first law of thermodynamics for the control volume in Fig. 1 results in

$$\dot{q}_{f,l} = \dot{m}_a h_a + \dot{m}_v h_v - \dot{m}_e h_e. \quad (4)$$

As an example, suppose now that the same flow rates of air and volatiles, both at temperature  $T_o$ , are mixed in a hypothetical combustion chamber. Furthermore, assume the combustion reactions are identical to those in the calorimeter in Fig. 1, and the products of combustion are cooled down to the reference temperature  $T_o$  without condensing water. This hypothetical situation is shown in Fig. 2. Application of the first law of thermodynamics for the combustion chamber control volume in Fig. 2 leads to

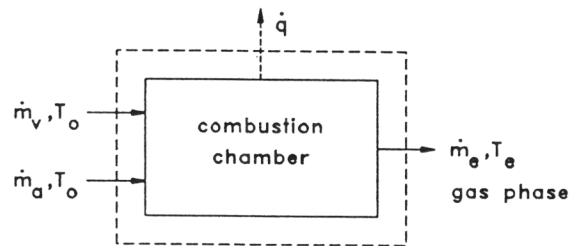


Fig. 2 Hypothetical combustion chamber

$$\dot{q} = \dot{m}_a h_a^o + \dot{m}_v h_v^o - \dot{m}_e h_e^o. \quad (5)$$

Here,  $\dot{q}$  is equal to the total rate of heat released by combustion in the flame. This heat release

rate is identical in Fig. 1 and Fig. 2, but it is distributed in different ways. By expressing the heat released per unit mass of volatiles, an effective heat of combustion can be defined as

$$\dot{m}_v \Delta h_{c,eff} \equiv \dot{q}, \quad (6)$$

or per unit exposed area

$$\dot{m}_v'' \Delta h_{c,eff} \equiv \dot{q}'' . \quad (7)$$

$\Delta h_{c,eff}$  is for the combustion reactions as they take place in the calorimeter.  $\Delta h_{c,eff}$  must be distinguished from the net heat of combustion,  $\Delta h_{c,net}$ , measured in an oxygen bomb calorimeter. The difference between  $\Delta h_{c,eff}$  and  $\Delta h_{c,net}$  is very significant for charring materials such as wood. In an oxygen bomb calorimeter, nearly all the mass of wood is consumed, leaving a small fraction of non-combustible ash (usually less than 1% by mass). The net heat of combustion,  $\Delta h_{c,net}$ , of dry wood is in the range of 16-18 kJ·g<sup>-1</sup>. When exposed under real fire conditions, only 70-80% of the mass is converted to volatiles that burn almost completely. The heat of combustion of the volatiles,  $\Delta h_{c,eff}$ , measured in a calorimeter is only 12-13 kJ·g<sup>-1</sup>. A solid char residue remains, primarily consisting of carbon, with a net heat of combustion of approximately 30 kJ·g<sup>-1</sup>. In an oxygen bomb calorimeter, most of this char is also burnt, explaining why  $\Delta h_{c,net}$  exceeds  $\Delta h_{c,eff}$  by 25-50%. Even for materials that do not form a char,  $\Delta h_{c,eff}$  can be significantly lower than  $\Delta h_{c,net}$  if combustion of the volatiles in the calorimeter is incomplete. In this case, the products of combustion contain measurable amounts of combustible components such as CO, soot, unburnt hydrocarbons, etc. The ratio of  $\Delta h_{c,eff}$  to  $\Delta h_{c,net}$  is defined as combustion efficiency,  $\chi$ . For clean-burning gaseous fuels, such as Methane,  $\chi$  is close to unity. For fuels that produce sooty flames, including gases,  $\chi$  can be significantly lower. For example,  $\chi$  for Acetylene is approximately 0.75.

Substitution of equations (1), (2), (3), and (5) into (4) leads to

$$\dot{q} - \dot{q}_{f,l} = c_p \dot{m}_e (T_e - T_o) - c_p \dot{m}_a (T_a - T_o) - c_p \dot{m}_v (T_v - T_o). \quad (8)$$

For most combustible materials, the stoichiometric air to fuel ratio ranges between 3 and 16. Moreover, bench-scale calorimeters are usually operated with excess air. For example, the standard initial flow rate in the Cone calorimeter<sup>3</sup> is 30 g·s<sup>-1</sup>. Based on the oxygen consumption principle (see below), the stoichiometric flow rate of air for a 10 kW fire (practical upper limit in the Cone calorimeter) can be calculated as [10 kW]/[3 kJ per g of air]=3.3 g·s<sup>-1</sup>. Thus, the air supply in the Cone calorimeter is at least 9 times stoichiometric, or at least 9x3=27 times the generation rate of volatiles. Usually, the ratio is much greater. Hence,  $\dot{m}_v$  is negligible compared to  $\dot{m}_a$  and equation (8) can be approximated as

$$\dot{q} - \dot{q}_{f,l} \approx \dot{m}_a c_p (T_e - T_a). \quad (9)$$

This equation is the basis for the sensible enthalpy method. Heat release rate is calculated from the temperature rise  $T_e - T_a$  of the gases flowing through a calorimeter. A schematic of a calorimeter based on this principle is shown in Fig. 3.

There are a few problems with the practical implementation of this technique. The main concern is that only a fraction of the heat released in the flame is used to raise the sensible enthalpy or temperature of the gases. Therefore, another method is needed to recover or measure the loss term,  $\dot{q}_{f,l}$ . Some calorimeters have water-cooled walls that trap most of the losses. These losses can be estimated by measuring the enthalpy rise of the cooling water. However, due to the additional hardware and instrumentation, such calorimeters are rather complex and difficult to operate. A more popular method relies on a gas burner calibration to determine  $\dot{q}_{f,l}$ , under the assumption that the losses are fuel-independent. Defining the loss fraction,  $\chi_R$ , by

$$\dot{q} - \dot{q}_{f,l} \equiv (1 - \chi_R)\dot{q}. \quad (10)$$

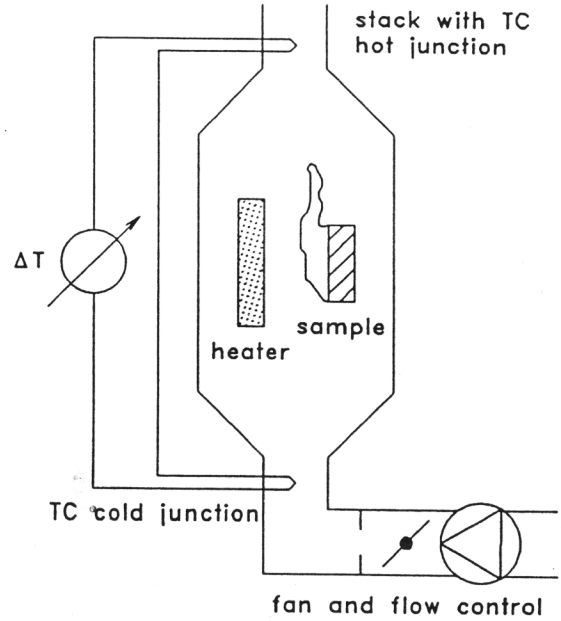


Fig. 3 Sensible enthalpy rise calorimeter

The symbol  $\chi_R$  is chosen for this fraction, since  $\dot{q}_{f,l}$  consists primarily of radiation. If the calorimeter is operated with a constant air flow rate  $\dot{m}_a$ , equation (9) can then be written as

$$\dot{q} \approx \frac{\dot{m}_e c_p}{1 - \chi_R} (T_e - T_a) \equiv k(T_e - T_a). \quad (11)$$

The calibration factor,  $k$ , is determined from a gas burner calibration with known  $\dot{q}$ . By repeating the calibration over a range of heat release rate levels,  $k$  can be determined as a function of  $\dot{q}$  or  $T_e$ . If the specimen is enclosed with the heater, equation (11) is still valid, provided a reference temperature  $T_r$  is used instead of  $T_a$ . The temperature difference  $T_r - T_a$  results from the heat transfer between the heater and the air flow through the enclosure.  $T_r$  is therefore a function of heater setting, to be determined via calibration.

Smith's rate of heat release test developed at Ohio State University is the most well-known and most widely used calorimeter based on the sensible enthalpy rise method<sup>4</sup>.

### Substitution Method

For practical reasons, calorimeters based on the sensible enthalpy rise method use a closed configuration. The specimen and heater(s) are located inside a metal box, which may be (partly) insulated. The dynamic response of the enclosure to changes in the thermal environment creates major problems in the practical implementation of the sensible enthalpy rise method. After ignition, part of the heat released by a burning sample is transferred by radiation to the enclosure walls. A fraction of this heat is stored in the walls, causing an increase of its temperature, in turn resulting in an enhanced heat transfer with the air flowing through the box.

The result is that, for a material which quickly reaches steady burning conditions, there is a delay for  $T_e$  to reach the corresponding steady temperature. A similar phenomenon occurs when heat release rate from the specimen decreases, or after the specimens burns out and heat release rate goes back to zero. Under unsteady burning conditions,  $T_e$  constantly lags behind the temperature corresponding to the instantaneous heat release rate. There are various ways to address this problem<sup>5,6,7,8</sup>, but none are completely satisfactory.

The substitution method was developed to eliminate problems associated with thermal lag. The method requires two runs to determine heat release rate of a material under a given set of conditions. The first run uses a similar arrangement as shown in Fig. 3. The temperature difference  $T_e - T_a$  is measured as a function of time. The second run uses the same apparatus, air flow rate and irradiance. However, the specimen is replaced by a non-combustible dummy specimen and a substitution gas burner. The flow of gas to the burner is controlled in such a way that the temperature difference  $T_e - T_a$  closely follows the curve measured during the first run. Fig. 4 shows a schematic of the substitution run.

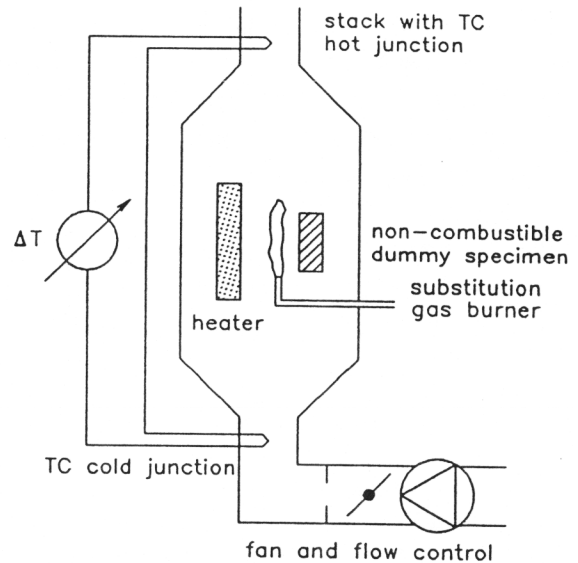


Fig. 4 Substitution run

Presumably, the dynamics are identical in both runs. Hence, problems with thermal lag have been eliminated, and the heat release rate of the specimen can be determined from the fuel flow rate to the burner in the second run. Unfortunately, implementation of this method is not trivial, since a sophisticated control system is needed for the second run. Moreover, due to the addition of substitution runs, the number of tests needed to evaluate a material are doubled.

The substitution method was first implemented at Factory Mutual<sup>9</sup>. The apparatus was designed to measure the heat release rate from roof assemblies. A bench-scale substitution calorimeter was developed more recently at the Forest Products Laboratory<sup>10</sup>.

### Compensation Method

A compensation calorimeter is similar to a substitution calorimeter, except that the burner is operated while a specimen is exposed. A schematic is shown in Fig. 5. Initially, the burner flow rate is chosen so that the corresponding heat release rate exceeds that of any material to be tested. During a test, the gas flow rate to the burner is controlled so that  $T_e - T_a$  remains constant. The heat release rate corresponding to the reduction in flow rate to the burner is equal to the heat release rate from the specimen.

The compensation method also eliminates problems with the dynamic response of the calorimeter enclosure. In theory, a compensation calorimeter is operated at a constant temperature. This would resolve another problem associated with the assumption that  $\dot{q}_{f,1}$  is fuel-independent, while



in reality it is not ( $\dot{q}_{f,1}$  is a strong function of the sootiness of the flame). In practice, however, the specimen and burner have to be separated to avoid that radiation from the burner flame enhances irradiance to the specimen. Hence, the calorimeter enclosure is not truly isothermal, and the problem remains unresolved. As with substitution calorimeters, the burner flow control system makes compensation calorimeters rather complex and difficult to operate. As a result, they are suitable only for research and not for routine testing.

Compensation calorimeters were developed at the National Bureau of Standards<sup>11,12</sup> and Stanford Research Institute<sup>13</sup>.

### Oxygen Consumption Method

In 1917, Thornton showed that for a large number of organic liquids and gases, a more or less constant net amount of heat is released per unit mass of oxygen consumed for complete combustion<sup>14</sup>. Huggett found this also to be true for organic solids and obtained an average value for this constant of  $13.1 \text{ kJ}\cdot\text{g}^{-1}$  of oxygen<sup>15</sup>. This value may be used for practical applications and is accurate with very few exceptions to within  $\pm 5\%$ . Thornton's rule implies that it is sufficient to measure the oxygen consumed in a combustion system in order to determine the net heat released. This is the basis for the oxygen consumption method for measuring heat release rate in fire tests.

Perhaps the first application of the oxygen consumption principle in fire research was performed by Parker on the ASTM E-84 tunnel test<sup>16</sup>. During the late 1970's and early 1980's, the oxygen consumption technique was refined at the National Bureau of Standards (NBS, currently the National Institute of Standards and Technology or NIST). The oxygen consumption method is now recognized as the most accurate and practical technique for measuring heat release rates from experimental fires. It is widely used throughout the world, both for bench-scale and large scale applications.

The basic requirement to use the oxygen consumption technique is that all of the combustion products are collected and removed through an exhaust duct. At a distance downstream sufficient for adequate mixing, both flow rate and composition of the gases are measured. A schematic of an oxygen consumption calorimeter is shown in Fig. 6. It is not necessary to

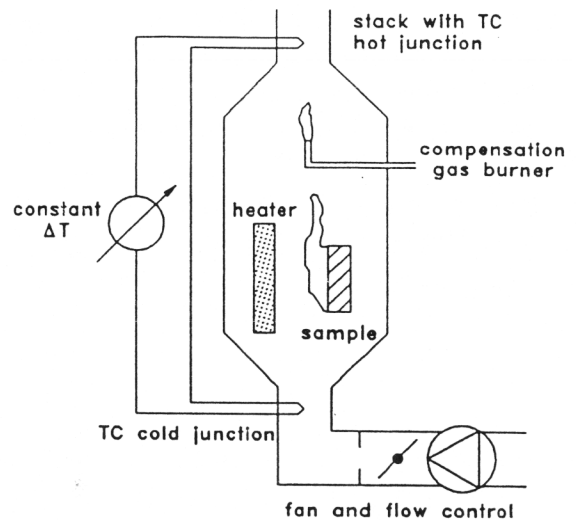


Fig. 5 Compensation calorimeter

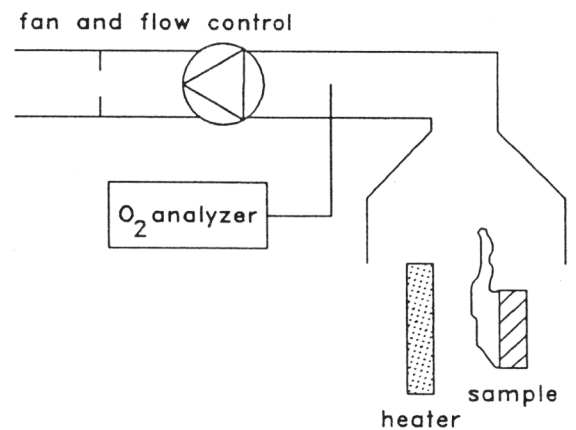


Fig. 6 Oxygen consumption calorimeter

measure the inflow of air, provided the flow rate is measured in the exhaust duct. Therefore, oxygen consumption calorimeters are typically open, to avoid that part of  $\dot{q}_{f,1}$  is reflected by the calorimeter walls and reaches the specimen surface. This would result in an uncontrolled irradiance, in addition to that from the heater.

The practical implementation of the oxygen consumption method is not straightforward. Application of Thornton's rule to the combustion system shown in Fig. 7 leads to the following equation for the heat release rate

$$\dot{q} = E(\dot{m}_a Y_{O_2}^a - \dot{m}_e Y_{O_2}^e), \quad (12)$$

where  $E$  = Heat release per mass unit of oxygen consumed ( $\approx 13.1 \text{ kJ}\cdot\text{g}^{-1}$ ),  
 $Y_{O_2}^a$  = Mass fraction of oxygen in the combustion air ( $0.232 \text{ g}\cdot\text{g}^{-1}$  in dry air), and  
 $Y_{O_2}^e$  = Mass fraction of oxygen in the combustion products ( $\text{g}\cdot\text{g}^{-1}$ ).

The problems with the use of this equation are threefold. First, oxygen analyzers measure the mole fraction and not the mass fraction of oxygen in a gas sample. Mole fractions can be converted to mass fractions by multiplying the mole fraction with the ratio between molecular weight of oxygen and molecular weight of the gas sample. The latter is usually close to the molecular weight of air ( $\approx 29 \text{ g}\cdot\text{mol}^{-1}$ ). Second, water vapor is removed from the sample before it passes through a paramagnetic analyzer, so that the resulting mole fraction is on a dry basis. This problem can be avoided by using a Zirconium Oxide analyzer, which measures oxygen mole fraction in a hot and wet sample. However, the performance of such analyzers is significantly inferior to that of paramagnetic instruments, making them unsuitable for accurate oxygen consumption calorimetry<sup>17</sup>. Third, flow meters measure volumetric rather than mass flow rates. The volumetric flow rate in the exhaust duct, normalized to the same pressure and temperature, is usually slightly different from the inflow rate of air because of expansion due to the combustion reactions.

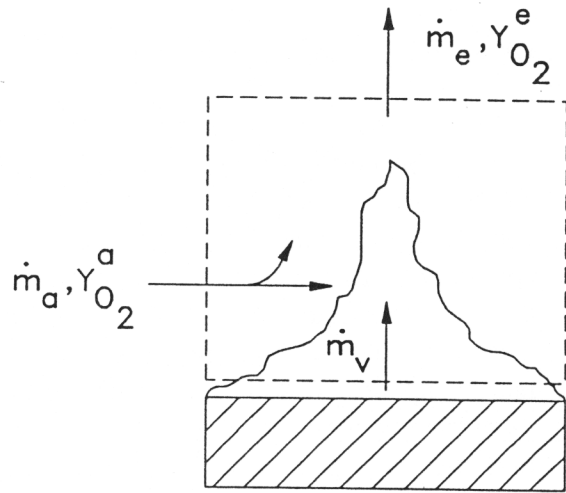


Fig. 7 Gas-phase oxygen balance

Equations for calculating rate of heat release by oxygen consumption for various applications were developed by Parker<sup>18</sup> and Janssens<sup>19</sup>. The differences in treatment and equations to be used are mainly due to the extent to which gas analysis is made. As a minimum, the oxygen concentration must be measured. However, accuracy can be improved by adding instrumentation for measuring the concentration of  $\text{CO}_2$ ,  $\text{CO}$  and  $\text{H}_2\text{O}$ . Equations for the most common configurations of the gas analysis system are given below. Detailed derivations are not repeated here, and can be found in the aforementioned references.

*Only O<sub>2</sub> is measured.* In this case all water vapor (by a cooling unit and a moisture sorbent) and CO<sub>2</sub> (by a chemical sorbent) must be removed from the exhaust gas sample stream before O<sub>2</sub> is measured. This leads to the assumption that the sample gas only consists of O<sub>2</sub> and N<sub>2</sub>. The resulting equation for calculating heat release rate is

$$\dot{q} = E \frac{\phi}{1 + \phi(\alpha - 1)} \dot{m}_e \frac{M_{O_2}}{M_a} \left[ 1 - X_{H_2O}^a - X_{CO_2}^a \right] X_{O_2}^{A^a}, \quad (13)$$

with

$$\phi = \frac{X_{O_2}^{A^a} - X_{O_2}^{A^e}}{\left[ 1 - X_{O_2}^{A^e} \right] X_{O_2}^{A^a}}, \quad (14)$$

where  $\phi$  = Oxygen depletion factor,  
 $\alpha$  = Volumetric expansion factor,  
 $M_{O_2}$  = Molecular weight of oxygen (28 g·mol<sup>-1</sup>),  
 $M_a$  = Molecular weight of the combustion air (29 g·mol<sup>-1</sup> for dry air),  
 $X_{H_2O}^a$  = Actual mole fraction of water vapor in the combustion air,  
 $X_{CO_2}^a$  = Actual mole fraction of carbon dioxide in the combustion air,  
 $X_{O_2}^{A^a}$  = Measured mole fraction of oxygen in the combustion air, and  
 $X_{O_2}^{A^e}$  = Measured mole fraction of oxygen in the exhaust flow.

As the composition of the fuel is usually not known, some average value has to be used for  $\alpha$ . Complete combustion of carbon in dry air results in  $\alpha=1$ . If the fuel is pure hydrogen,  $\alpha$  is equal to 1.21. A recommended average value for  $\alpha$  is 1.105.  $X_{H_2O}^a$  can be calculated from the relative humidity and temperature in the laboratory. Typically it is less than a few percent in a temperature-controlled laboratory.  $X_{CO_2}^a$  in dry air is 330 ppm. Note that the symbols for oxygen mole fraction measured in the combustion air (prior to a test) and the exhaust flow include a superscripted A. This is to make a distinction between the actual and measured mole fractions of oxygen, with the latter on a dry gas sample basis.

Equation (13) is expected to be accurate to within  $\pm 10\%$  provided combustion is complete; i.e., all of the carbon is converted to CO<sub>2</sub>. The error might be larger if CO or soot production is considerable, or if a significant amount of combustion products consist of species other than CO<sub>2</sub> or H<sub>2</sub>O (e.g. HCl). The error is partly due to the uncertainty of  $E$  and  $\alpha$ . If more exact values are available, accuracy can be improved by using those instead of the generic values of 13.1 kJ·g<sup>-1</sup> and 1.105.

*O<sub>2</sub> and CO<sub>2</sub> are measured.* In this case, only water vapor is trapped before the exhaust gas sample reaches the analyzers. The rate of heat release is given by equation (13), with the minor modification that  $X_{CO_2}^a$  is not included in the expression inside parentheses. In addition,  $\phi$  is slightly different and follows from

$$\phi = \frac{X_{O_2}^{A^a} \left[ 1 - X_{CO_2}^{A^e} \right] - X_{O_2}^{A^e} \left[ 1 - X_{CO_2}^{A^a} \right]}{\left[ 1 - X_{O_2}^{A^e} - X_{CO_2}^{A^e} \right] X_{O_2}^{A^a}}, \quad (15)$$

where  $X_{CO_2}^{A^a}$  = Measured mole fraction of carbon dioxide in the air ( $\approx 330$  ppm), and  
 $X_{CO_2}^{A^e}$  = Measured mole fraction of carbon dioxide in the exhaust flow.

Generally, adding  $CO_2$  measurement does not greatly improve accuracy of  $\dot{q}$ .

*O<sub>2</sub>, CO<sub>2</sub> and CO are measured.* If a significant fraction of carbon in the fuel is converted to CO instead of  $CO_2$ , the equations may have to be corrected to take incomplete combustion into account. Heat release rate is now calculated from

$$\dot{q} = \left[ E\phi - (E_{CO} - E) \frac{1 - \phi}{2} \frac{X_{CO}^{A^e}}{X_{O_2}^{A^e}} \right] \frac{\dot{m}_e}{1 + \phi(\alpha - 1)} \frac{M_{O_2}}{M_a} \left[ 1 - X_{H_2O}^a \right] X_{O_2}^{A^a}, \quad (16)$$

with

$$\phi = \frac{X_{O_2}^{A^a} \left[ 1 - X_{CO_2}^{A^e} - X_{CO}^{A^e} \right] - X_{O_2}^{A^e} \left[ 1 - X_{CO_2}^{A^a} \right]}{\left[ 1 - X_{O_2}^{A^e} - X_{CO_2}^{A^e} - X_{CO}^{A^e} \right] X_{O_2}^{A^a}}, \quad (17)$$

where  $X_{CO}^{A^e}$  = Measured mole fraction of carbon monoxide in the exhaust flow.

*O<sub>2</sub>, CO<sub>2</sub>, CO and H<sub>2</sub>O are measured.* Often the combustion products comprise only  $O_2$ ,  $CO_2$ , CO,  $H_2O$  and  $N_2$  in significant amounts. In that case the expansion factor no longer has to be estimated, but can be calculated. Heat release rate is calculated from

$$\dot{q} = \left[ E\phi - (E_{CO} - E) \frac{1 - \phi}{2} \frac{X_{CO}^{A^e}}{X_{O_2}^{A^e}} \right] \dot{m}_a \frac{M_{O_2}}{M_a} \left[ 1 - X_{H_2O}^a \right] X_{O_2}^{A^a}, \quad (18)$$

with

$$\frac{\dot{m}_a}{M_a} = \frac{(1 - X_{H_2O}^e)(1 - X_{O_2}^{A^e} - X_{CO_2}^{A^e} - X_{CO}^{A^e})}{(1 - X_{H_2O}^a)(1 - X_{O_2}^{A^a} - X_{CO_2}^{A^a})} \frac{\dot{m}_e}{18 + 4(1 - X_{H_2O}^e)(X_{O_2}^{A^e} + 4X_{CO_2}^{A^e} + 2.5)} \quad (19)$$

where  $X_{H_2O}^e$  = Actual mole fraction of water vapor in the exhaust flow.

$\phi$  is still determined according to equation (17).

## Conclusions

The oxygen consumption technique is the most accurate and convenient way to measure the heat release rate from fires. Problems due to thermal lag are eliminated. Drawbacks of the technique are the high cost of instrumentation (only the best available oxygen analyzers are adequate), and the need for a rigorous calibration and maintenance schedule. Nevertheless, the benefits outweigh the disadvantages.

Heat release rate can also be measured on the basis of the carbon dioxide that is generated. This technique is used extensively at Factory Mutual Research Corporation<sup>20</sup>. It has the advantage that it is easier and less costly to measure carbon dioxide with sufficient accuracy, than it is to measure oxygen. However, the amount of energy generated per mass unit of carbon dioxide generated is much more fuel-dependent than the amount of energy produced per mass unit of oxygen consumed. Therefore, this technique is not as versatile and not as universally accepted as the oxygen consumption method.

If high accuracy is not critical, the sensible enthalpy rise method can be considered because of its simplicity and the rudimentary instrumentation that is needed. However, it is difficult to eliminate dynamic errors associated with thermal lag. The two remaining techniques, substitution and compensation, greatly reduce such errors at the expense of ease and cost of operation.

## References

1. Babrauskas, V. and Peacock, R., "Heat Release Rate: The Single Most Important Variable in Fire Hazard," *Fire Safety J.*, Vol 18, 1992, pp. 255-272.
2. Janssens, M., "Calorimetry," in *The SFPE Handbook of Fire Protection Engineering*, Second Edition, Chapter 3-22, Society of Fire Protection Engineers, Boston, MA, 1995.
3. "ASTM E 1354: Test Method for Heat and Visible Smoke Release Rates for Materials and Products Using an Oxygen Consumption Calorimeter," *ASTM Fire Test Standards*, 4<sup>th</sup> Edition, ASTM, Philadelphia, PA, 1993, pp. 968-984.
4. "ASTM E 906: Test Method for Heat and Visible Smoke Release Rates for Materials and Products," *ASTM Fire Test Standards*, 4<sup>th</sup> Edition, ASTM, Philadelphia, PA, 1993, pp. 877-892.

5. Evans, D., and Breden, L., "Time Delay Correction for Heat Release Rate Data," *Fire Technology*, Vol 14, 1978, pp. 85-96.
6. Bluhme, D., and Getka, R., "Rate of Heat Release Test - Calibration, Sensitivity and Time Constants of ISO RHR Apparatus," NORDTEST Project 115-77, National Institute for Testing of Materials, Copenhagen, Denmark, 1979.
7. Vandeveld, P., "An Evaluation of Heat Release Criteria in Reaction-to-Fire Tests," *J. of Fire and Materials*, Vol 4, 1980, pp. 157-162.
8. Abramowitz, A., and Lyon, R. "Comparison of Heat Release Rate from Deconvoluted OSU and Oxygen Consumption Principle Calorimeter Signals," *Proceedings of the 2<sup>nd</sup> Fire and Materials Conference*, Interscience Communications, London, England, 1993, pp. 161-170.
9. Thompson, N., and Cousins, E., "The FM Construction Materials Calorimeter," *NFPA Quarterly*, Vol 52, 1959, pp. 186-192.
10. Brenden, J., "Apparatus for Measuring Rate of Heat Release from Building Materials," *J. of Fire & Flammability*, Vol 6, 1975, pp. 50-64.
11. Parker, W., and Long, M., "Development of a Heat Release Rate Calorimeter at NBS," in *Ignition, Heat Release and Noncombustibility of Materials*, ed. A. Robertson, American Society of Testing and Materials, STP 502, 1972, pp. 135-151.
12. Tordella, J., and Twilley, W., "Development of a Calorimeter for Simultaneously Measuring Heat Release and Mass Loss Rate," NBSIR 83-2708, National Bureau of Standards, Gaithersburg, MD, 1983.
13. Martin, S., "Characterization of the Stanford Research Institute Large-Scale Heat-Release Rate Calorimeter," NBS-GCR 76-54, National Bureau of Standards, Gaithersburg, MD, 1975.
14. Thornton, W., "The Relation of Oxygen to the Heat of Combustion of Organic Compounds," *Philosophical Magazine and J. of Science*, Vol 33, 1917.
15. Huggett, C., "Estimation of the Rate of Heat Release by Means of Oxygen Consumption," *J. of Fire and Materials*, Vol 12, 1980, pp. 61-65.
16. Parker, W., "An Investigation of the Fire Environment in the ASTM E-84 Tunnel Test," NBS Technical Note 945, National Bureau of Standards, Gaithersburg, MD, 1977.
17. Nussbaum, R., "Oxygen Consumption Measurements in the Cone Calorimeter - A Direct Comparison between a Paramagnetic Cell and a High-Temperature Cell," *J. of Fire and Materials*, Vol 11, 1987, pp. 201-203.
18. Parker, W., "Calculations of the Heat Release Rate by Oxygen Consumption for Various Applications," NBSIR 81-2427, National Bureau of Standards, Gaithersburg, MD, 1982.
19. Janssens, M., "Measuring Rate of Heat Release by Oxygen Consumption," *Fire Technology*, Vol 27, 1991, pp. 234-249.
20. Tewarson, A., "Reliable Small-Scale Fire Testing Apparatus," *Modern Plastics*, 1980, pp. 58-62.

## HEAT RELEASE RATE "CALORIMETRY"

Edwin E. Smith

Ohio State University, Chemical Research  
140 W. 19th Ave., Columbus, OH 43210

The OSU Release Rate "Calorimeter" was developed in the early 70's as part of an A.I.S.I. (American Iron & Steel) project to determine, quantitatively, "how a fire burns." One of the major factors that describes a fire's severity is rate of heat release (RHR). Since there was no convenient nor small scale method for measuring RHR, as a function of time, from a small (150 by 150 mm) surface exposed to a constant externally applied incident flux.

In concept, a constant mass flow of air was to pass through the apparatus, and the rate of heat release determined by monitoring the temperature change ( $\Delta T$ ) of the gas phase entering and leaving. The equipment was to have the least possible mass in contact with flowing gas to minimize the effect of heat absorption. The system was calibrated using known flow rates of hydrocarbon gases (usually methane) of precisely known heating value. The rate of heat release was thus established as a function of observed  $\Delta T$  and includes both the convective and radiative heat from the luminous methane flame.

For cellulosic and most other low-smoke materials used in structures and furnishings, the calibration based on methane gas is adequate since ratios of radiant to convective heat release are similar. For some burning materials this ratio is significantly different and methane gas is not an acceptable calibrating standard.

Rather than using a range of calibration standards of differing convective-to-radiative ratios, a direct approach has been taken to consider the contribution of both forms of heat release. By monitoring the temperature increase of walls surrounding the combustion gases, the total heat released by a burning sample can be determined directly. Details of the procedure will be described.

## "Heat Release Rate 'Calorimetry'"

Edwin E. Smith  
The Ohio State University

I do not like to refer to the OSU Release Rate apparatus as a "Calorimeter". To me, a calorimeter is an instrument that produces very precise data related to a basic property. A release rate apparatus does not produce precise data nor does it measure a basic property. Heat release rates from burning materials of practical interest such as furnishings, finishes, composites, etc., are notoriously non-repeatable by the very nature of the burning process. Anyone who has observed such tests are aware of the inconsistencies due to changing surfaces, delamination, spalling, non-uniform penetration, and the effect these uncontrollable factors have on rate of heat release.

Rate of heat release is anything but a basic property; it varies with almost everything; primarily imposed heat flux and time. But in spite of these deficiencies, release rate data are some of the most important information available for analyzing fires and fire performance of materials.

The value of release rate data to fire system evaluation can be shown by recognizing that a fire system is an unsteady-state reaction with large generation and loss rates. In such systems the concentration of heat (temperature), visible smoke, and toxic gases, which describe hazard level, depend on the rate as well as the quantity generated. Methods of describing fire performance of materials and the potential hazard of a fire system therefore require release rates as input data. Since release rates are functions of exposure conditions and exposure conditions which develop in real fires depend on release rates of all objects contributing to the fire, release rates over a range of conditions are necessary for a quantitative analysis of a fire system.

The OSU Release Rate apparatus was available in its basic form in the early '70's. It was developed as part of an A.I.S.I. (American Iron and Steel Institute) project to determine, quantitatively, "how a fire burns." At the start of the project in 1968, there was no convenient nor small scale method for measuring Rate of Heat Release (RHR) as a function of time and incident flux. Therefore the first major effort was to devise equipment and operating procedures



to measure RHR vs. Time from a small (150 mm by 150 mm) surface exposed to a series of constant, externally applied, heat flux.

In concept, RHR was to be determined by measuring the temperature change ( $\Delta T$ ) of a constant mass flow of air ( $\dot{m}_a$ ) through the apparatus as heated by the burning sample. Its change in enthalpy was calculated using the familiar " $\dot{m}_a c_p \Delta T$ " equation. The equipment was to have the least possible mass in contact with the flowing gas to minimize the effect of heat absorption in the walls. The system was calibrated using known flow rates of a hydrocarbon gas (usually methane) of precisely known net heating value. The rate of heat release was thus established as a function of the observed  $\Delta T$  and includes both the convective and radiative heat from the luminous hydrocarbon flame. Figure 1 describes the FAA version of the OSU now in use.

To reduce radiant and convective heat absorption on walls of the pyramidal section, an annular space between the double wall was swept with an air flow three times that going through the environmental chamber. Although this reduced heat absorption and decreased response time, heat adsorption on walls of the main body had a significant effect on response time and heat recovered within the time frame of a normal test. Both analytical and analog methods have been used to compensate for the thermal inertia of the apparatus. These are satisfactory for materials having radiative/convective heat release ratios similar to calibration standards used. For materials with much higher ratios, relative absorption on walls is greater and these simple, fixed, thermal inertia compensation methods are not satisfactory.

For cellulosic and most other low-smoke materials used in structures and finishes, the calibration based on methane gas is adequate since ratios of radiant to convective heat release are similar. Some materials generate combustion zones having significantly higher temperatures and/or emissivities which increases this ratio to the point that methane gas is not a good calibrating standard.

A range of calibration standards with differing radiative/convective ratios could be used. But these ratios are not available for many materials; neither are they constant in actual fires. Instead, a direct approach has been taken that measures the contribution of both forms of heat release. By monitoring the temperature change of the walls surrounding the combustion gases,

the total heat released by a sample can be determined in terms of heat balances on and within the total system.

Heat Absorption Compensation:

By a heat balance on the flow system:

$$\dot{H}_i + \dot{H}_R = \dot{H}_0 + \dot{H}_1 + dH_W/dt$$

where:  $dH_W/dt = mc_p(dT_W/dt)$

$\dot{H}_i$  = Rate of heat input from radiant panel, air (kW)

$\dot{H}_R$  = Rate of Heat Release (RHR) from sample (kW)

$\dot{H}_0$  = Rate of heat flow in gas stream leaving (kW)

$\dot{H}_1$  = Rate of heat loss to surroundings (kW)

$H_W$  = Enthalpy of metal "wall" (kJ)

$T_W$  = Temperature of metal "wall" (°K)

$m$  = mass of metal "wall" (kg)

$c_p$  = Heat capacity of metal "wall" (kJ/kg,°K)

ss = subscript indicating steady state value

At Steady State (Initial Conditions) prior to sample injection:

$$dH_W/dt = 0 \quad \text{and} \quad \dot{H}_R = 0$$

Using Steady State as reference, and noting that  $\dot{H}_1$  does not change during a test, the Rate of Heat Release,  $\Delta\dot{H}_R = \dot{H}_R - \dot{H}_{R_{SS}}$ , at any time "t" is:

$$\Delta\dot{H}_R = \Delta\dot{H}_0 + \Delta\dot{H}_1 + mc_p(dT_W/dt)$$

The outlet gas temperature is monitored by a thermopile having 5 hot junctions across the outlet of the RHR apparatus. The heat flow is calculated assuming a constant heat capacity for the uniform mass flow of air through the equipment.

The metal "wall" temperature ( $T_W$ ) is measured by a) Chromel-Alumel thermocouples silver-soldered on the exterior

surface of the metal wall, 50 mm below the air manifold at the base of the pyramidal section and 50 mm forward of the radiant panel pan on each side of the environmental section, and b) a thermocouple silver-soldered to a 20 mm square piece of 30 mil stainless steel mounted on the right side, 180 mm directly below the TC described above and insulated from the metal wall by a 10 mm thick section of "Kaowool" insulation. The purpose of the two types of mounting was to provide a heat receptor more representative of the different types of metal surfaces in the OSU that are exposed to the radiant and convective flux.

The values for "heat loss" ( $\dot{H}_l$ ) and a " $mc_p$ " value representative of the heated metal walls of the RHR apparatus were evaluated based on the following relationships:

When steady state conditions are reached with a known, constant,  $\dot{H}_R$  (e.g. from electrically heated panel, or gas flame), then:  $dH_w/dt = 0$ , and

$$\Delta \dot{H}_l = \Delta \dot{H}_R - \Delta \dot{H}_0 = c(T_{w_{SS}} - T_{w_{SSi}})$$

where:  $T_{w_{SSi}}$  = wall temp., initial steady state ( $^{\circ}K$ )

$c$  = heat transfer coefficient ( $kW/^{\circ}K$ )

The heat loss thus calculated is that due to the change in metal wall temperature caused by the absorption of heat from  $\dot{H}_R$ . A value for " $c$ " can be calculated since all other terms in the equation are known. " $c$ " is a function of  $T_w$  as well as  $(T_{w_{SS}} - T_{w_{SSi}})$  because the thermal conductivity of the fiber glass insulation on the exterior of the apparatus changes significantly with temperature and is determined by repeating the steady-state experiment at different levels of input to the "Globars."

On cool-down, after  $\dot{H}_R$  is set to zero; at any time " $t$ ":

$$mc_p = (\dot{H}_0 + \dot{H}_l) / (dT_w/dt)$$

from which a " $mc_p$ " representative of the heated metal walls can be calculated by finding the slope of the wall temperature vs time curve at time " $t$ ".

### Evaluation of Compensation Method:

Using the calculated values of  $\dot{H}_1$  and  $mc_p$ , the efficacy of this method to account for both convective and radiative heat release was checked experimentally. Two different types of heat sources were used: a) an electrically heated ceramic panel, 100mm by 250 mm, operated at a heat input of 1.8 kW., and b) a methane gas flame.

The electrical panel was chosen so as to provide a high radiative-to-convective heat release ratio. Depending on the orientation of the panel; vertical, horizontal, or sloped, the radiative component varied from 80 to 85% of the total heat release to the system.

The panel was preheated, allowed to reach steady state at 1.8 kW before being injected into the RHR apparatus. Figures 2 and 3 show the release rate curves for total heat, both convective and radiative, calculated by the procedure just described. It is interesting to note that regardless of the position or orientation of the heating panel, the calculated results agree within 10%, suggesting that the position of the thermocouples monitoring wall temperatures are not critical to finding a representative " $mc_p$ ". It should also be noted that the responses of both a) and b) type thermocouples were similar. Changing their relative outputs by as much as 30 % had little effect on the calculated RHR.

The compensation method appears to be a reliable means of determining total heat release. Calculated RHR values agree closely with known heat inputs from sources having very different radiative/convective heat release ratios (Figures 2 through 5). The uncompensated output using the standard FAA procedure, is shown for comparison. The close agreement between the two outputs with natural gas (Figs. 4 and 5), which has a low radiative to convective ratio, and the large difference with the panel, which has a very high radiative to convective ratio (Fig. 2 and 3), is noted. This illustrates the higher rate of heat transfer to the walls by radiative, compared to convective, transfer. Since the FAA procedure does not use thermal inertial compensation, the difference may be somewhat exaggerated, particularly when sharp peaks occur such as seen in Figures 6,7 and 8.

For those materials having the highest radiative/convective ratios, the heat release found using the FAA procedure is

significantly lower than the actual total heat released. But it certainly is not as great as has been commonly assumed. For low smoke materials such as aircraft interior composites similar to that described by Figure 9 (a decorative laminate on phenolic/glass facing, on a "Nomex" honeycomb core), the differences in compensated and noncompensated heat release are less than 10% of the total.

By compensating for heat absorbed by the walls, this procedure also greatly improves the time response of the OSU as would be expected by the mathematical analysis above. The slight deviation from the square wave input shown in Figs. 4 and 5 is due in part to the "smoothing" routine for wall temperatures used in the calculations.

Please note that the RHR for Figures 2 through 9 are not on a "per unit area" basis as usually reported, but simply the rate of heat released by the source (kW). The plywood (Fig.7) was 150 by 150 mm, with nominal thicknesses of 3/16". The ABS, and polystyrene samples were 75 mm by 75 mm 125 mil thick. The aircraft composite was 150mm by 150mm, 1/2 inch nominal thickness.

For our OSU apparatus, the calculated values for "mc<sub>p</sub>" of the heated metal walls is 3.58 (kW/°K) and "c", the heat transfer coefficient in the heat loss term, is given by:

$$c=0.0014*10^{0.00136*Twss} \text{ (kW/°K)}$$

#### Acknowledgements:

Many improvements in the OSU's operating procedures and mechanical details have been made since the early '70s. The ASTM Task Group responsible for its evolution to an ASTM Test Method (E906) and in particular, the personnel of the FAA Technical Center and members of the Aircraft Materials Fire Test Working Group have contributed much to its present state of development. Figure 1, prepared by the FAA Technical Center, was taken from the "Aircraft Material Fire Test Handbook."

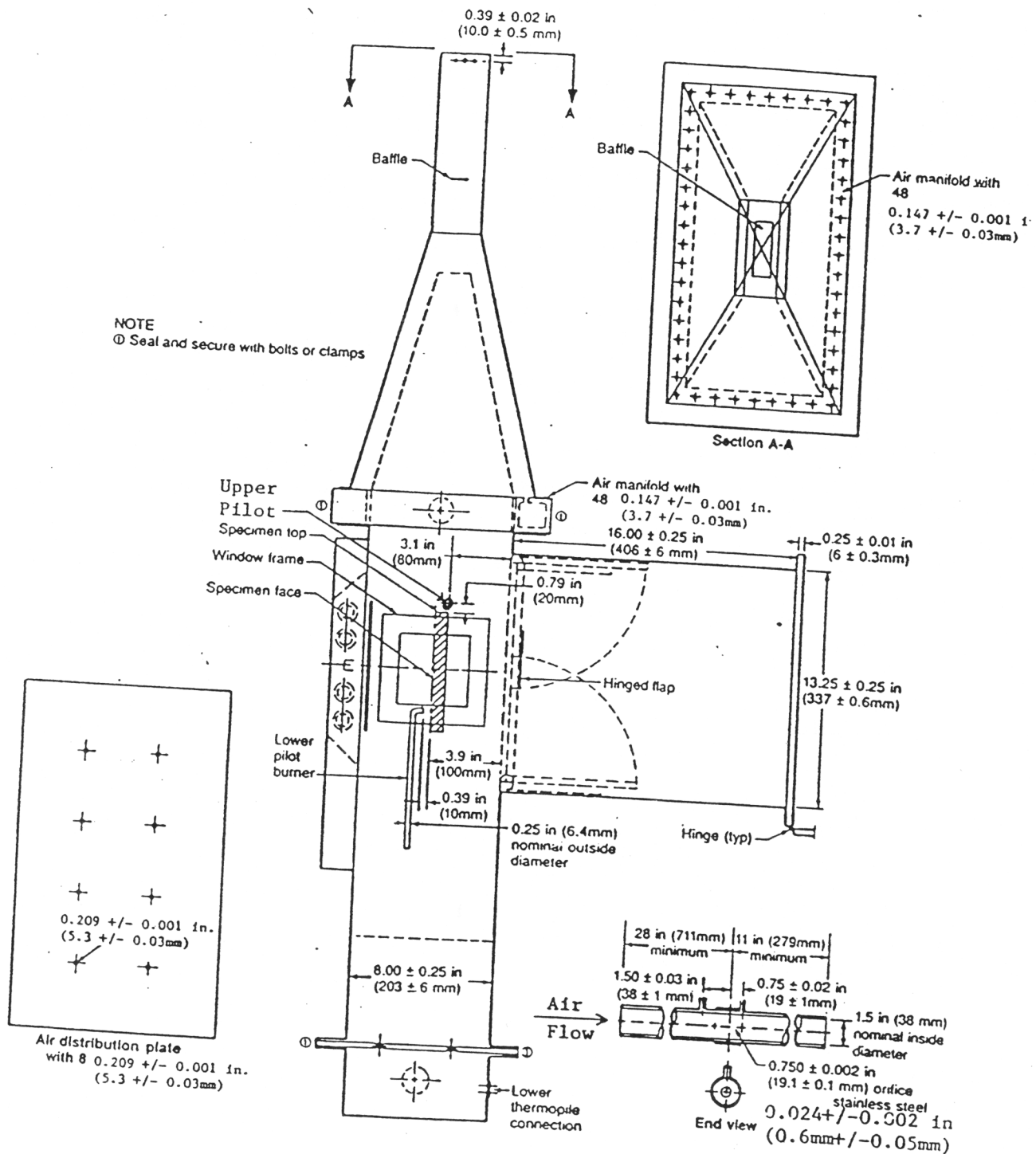


Figure 1: Rate of Heat Release Apparatus

Figure 2  
Electric Panel, Vertical  
Flux = 0 Input = 1.8 kW

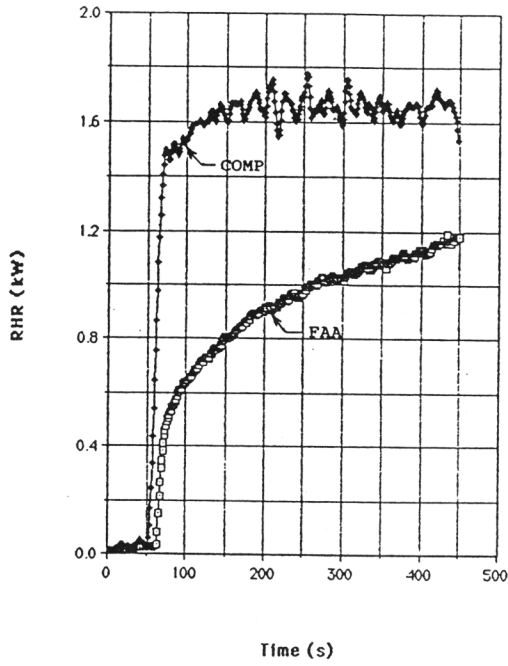


Figure 3  
Electric Panel, Horz.  
Flux=0 Input=1.8 kW

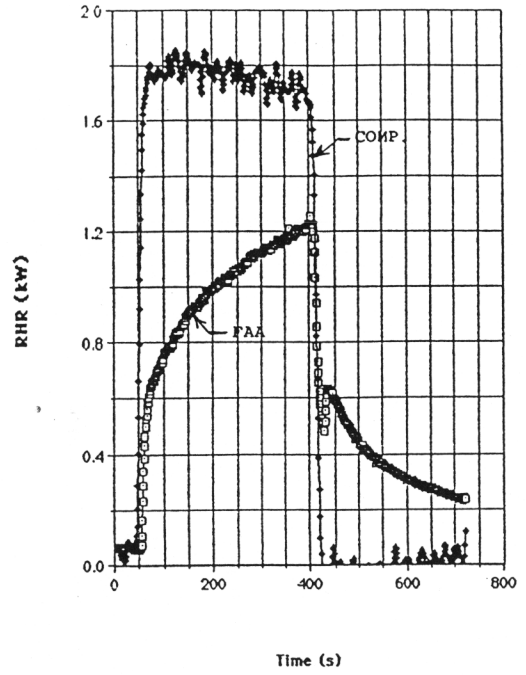


Figure 4  
Methane: FLUX=0; Input=3.9 kW

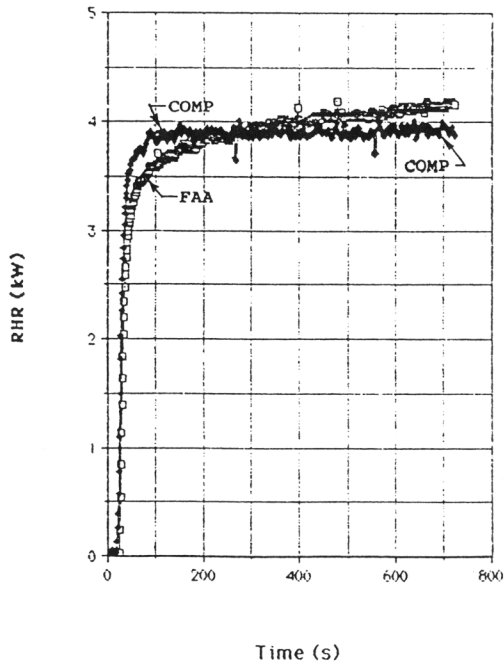


Figure 5  
Methane: Flux=3.5; Input=2.8m kW

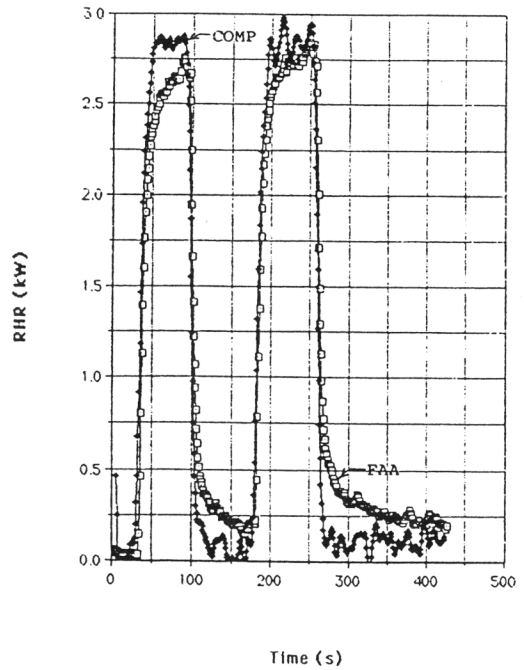


Figure 6  
ABS; Flux=3.5W/cm<sup>2</sup>

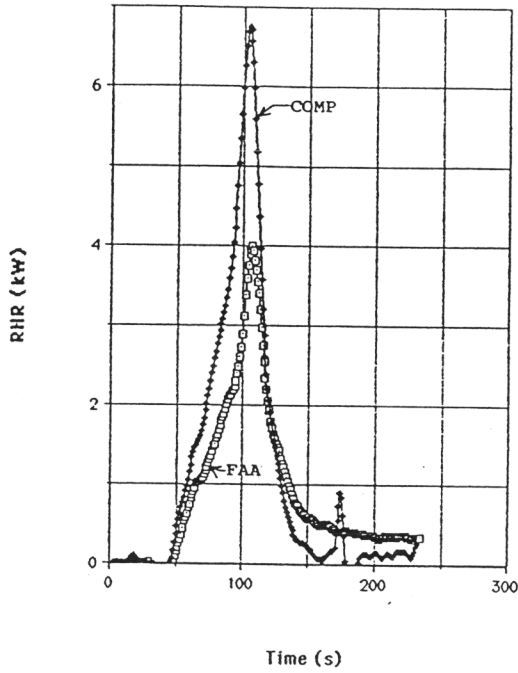


Figure 7  
3/16" Plywood: Flux=3.5 W/cm<sup>2</sup>

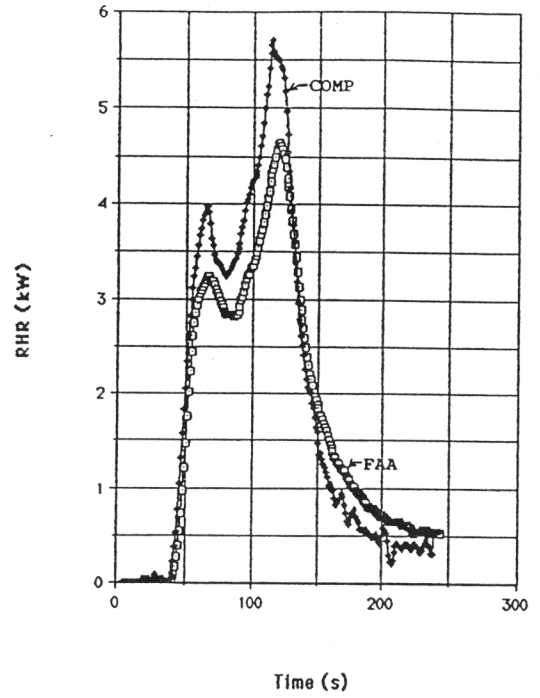


Figure 8  
Polystyrene; Flux=3.5W/cm<sup>2</sup>

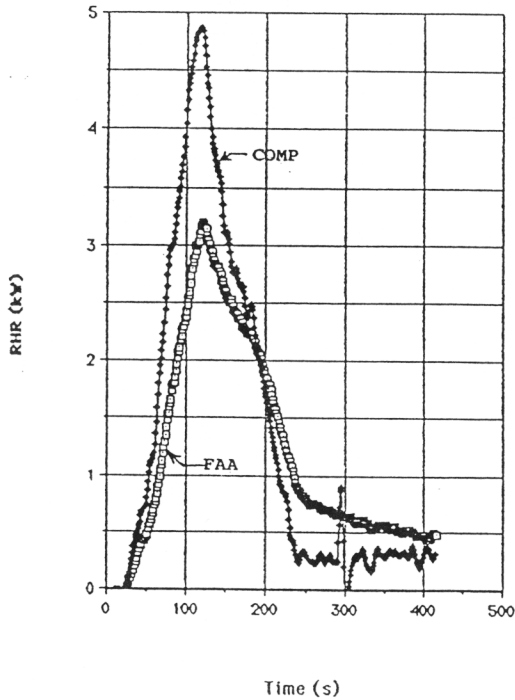
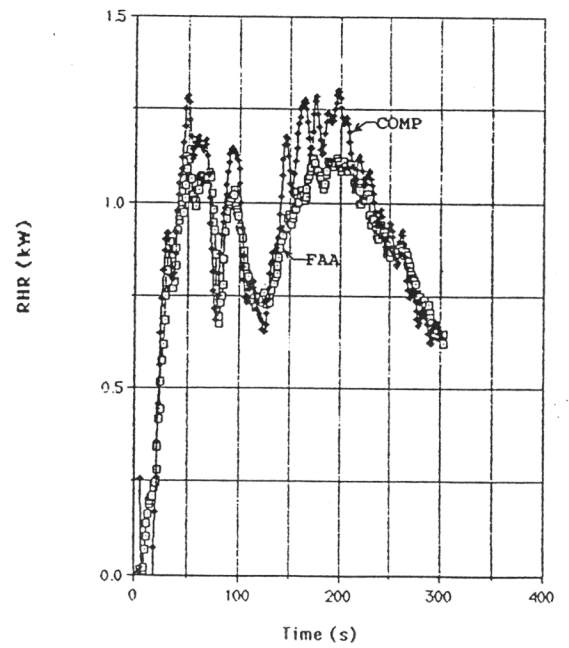


Figure 9  
Aircraft Composite: Dec.,Phenolic-F.G.Lam.  
Flux=3.5 W/cm<sup>2</sup>: -Nomex Honeycomb





## OXYGEN CONSUMPTION CALORIMETRY: ASTM AND ISO APPARATUSES

*Vytenis Babrauskas*

Fire Science and Technology Inc., 3609 Old Pacific Hwy. S., Kelso WA 98626

### Abstract

Today the measurement of heat release rate (i.e., rate of combustion energy evolution) from fires is normally done using oxygen consumption calorimetry, for both bench- and large-scale methods. The paper traces some of the history of instruments developed for oxygen consumption calorimetry and point out how they solved certain problems inherent in previous techniques. It also explains why traditional methods of calorimetry (e.g., bomb calorimetry) are normally not applicable to the study of fire hazards. It then discusses some of the primary HRR methods adopted by ASTM and by ISO. The Cone Calorimeter (ASTM E 1354; ISO 5660) is presented as the HRR technique which is now the most widely used bench-scale research tool: over 130 laboratories around the world have outfitted with this instrument. Its name arises due to the truncated-cone shape of the heater.

For large-scale testing, it is shown that the instrumentation is basically identical for open-burning calorimeters and for room calorimeters. The open-burning calorimeter is adopted by ASTM as ASTM E 1537. The room calorimeter is specified by ISO as ISO 9705. Both of these differ from the bench-scale calorimeter in that the former provides an external heating source (of up to  $100 \text{ kW m}^{-2}$ ). The open calorimeter and the room calorimeters, however, use a large ignition source, but the specimen is not further subjected to a radiant heat source.

For certain irregular and modular products, an intermediate-scale HRR apparatus is also convenient. ASTM has standardized this as ASTM E 1623, the 'ICAL' method.

Together, these techniques have changed the face of the measurement technology of fire safety engineering. Earlier HRR technologies existed in only specialized contexts. The oxygen-consumption based calorimeters standardized by ASTM and ISO, however, are now a mainstay of quantitative fire predictions. This has occurred because of the realization within the profession that heat release rate is the single most important variable in describing fire hazard. In turn, the instrumental techniques described have been rigorously enough standardized to allow them to become viewed as routine tools, so that users could be specialists in other technologies (e.g., polymer science) and not needing to be instrument designers.

### Background

At first glance, one might think that HRR measurement, as a specific measurement technology, would be unnecessary. What could be wrong with making mass loss measurements, then multiplying those results by a heat of combustion, with the latter obtained from oxygen bomb calorimetry? Such an approach, in fact, sometimes is viable. The most common area where such a tack would taken is in the burning of pools of simple hydrocarbon liquids. For these, published heat of combustion values are available, and mass loss measurements can be accomplished.

In general, however, there are two drawbacks to such procedures. (1) Obtaining mass loss rates requires numerical differentiation of the original mass data. Differentiation techniques invariably introduce significant noise (or else require drastic smoothing). (2) A majority of products involved in accidental fires do not show actual heats of combustion which are at all similar to their oxygen bomb values. Furthermore, the values are typically time dependent. Fig. 1 illustrates a practical example of this time-dependence. The result is that it is desirable to measure HRR itself, and not to attempt to impute it from mass loss data.

## Early bench-scale HRR test methods

The earliest test method developed specifically for measuring heat release rate was the FM Construction Materials Calorimeter, developed by Thompson and Cousins at the Factory Mutual Research Laboratories in 1959 [1]. This was a medium-sized apparatus, with a specimen size of 1.22 m by 1.22 m. The principle of apparatus might best be described as a '*substitution method*.' A specimen was inserted into the apparatus and subjected to a prescribed exposure from an oil burner fire. The exhaust stack temperature was recorded, as a function of time. A second test run was then made, with a non-combustible blank substituted for the specimen. Propane gas was metered into the evaluating burners, with the flow being adjusted so that the stack temperature record would duplicate the earlier result. The combustion energy represented by the metered propane was then taken to correspond to the heat release rate of the specimen. This was followed by other developments along these lines, but none of these schemes ever came into wide use.

By 1972 an improved design principle was available. It was discovered by Parker and Long [2] that an instrument could be made which was related to the substitution-test type design, but which would not require two runs per specimen, and which would be true to the actual time-resolved nature of the specimen's combustion. In present-day terminology this would be called an '*isothermal*' design. In this design, a control section is established in the stack, where thermocouples are used to monitor the temperature of the exhaust gases. An auxiliary burner, supplied with propane, is located some ways above the specimen. The valve controlling the propane flow is put into a servo loop, with an array of thermocouples, located in the exhaust stack, being used for setpoint sensing. When a specimen ignites and releases heat, a rise of the thermocouple temperature would ensue. Because of the servo loop, however, this increased heating is sensed, and the control valve to the auxiliary burner turns down the gas flow to the auxiliary burner, maintaining the thermocouples at the setpoint temperature. The heat release rate is determined by including a mass flow measuring device in the propane supply line. The specimen's heat release rate is, then, equal to the decrease in the propane flow, expressed in heat units. This was followed by several similar designs, including an NBS-II version. This scheme proved to be reasonably accurate and reliable, but it was difficult to simplify it enough to allow commercial instruments to be built.

The first heat release rate instrument to achieve some currency outside of major research organizations was the Ohio State University (OSU) apparatus, first described by E. E. Smith in 1972 [3]. It embodied rather different principles than the previous units. All of the prior units encompassed some idea of heat substitution, whether sequentially, in the same spot, or simultaneously, but offset in location. The OSU unit used a much simpler concept, that of the '*insulated box*.' According to basic principles, one could build an *adiabatic* heat release rate calorimeter. In such a device, the walls would—by definition—have no heat losses associated with them. The heat contributed by the specimen would be manifested directly as the difference between the sensible enthalpy of the incoming, and the exiting air stream. It is, of course, possible to build adiabatic walls. These are normally active

systems, whereby the temperature gradient across a thickness profile is monitored; a feedback loop is then used to supply heat to an interstitial heater to maintain the effective gradient—and, therefore the heat transfer—at zero. Such an arrangement is often incorporated into instruments for measuring thermal conductivity [4]; however, to make up a heat release rate calorimeter in this fashion would be costly and has never been attempted. Instead, the OSU apparatus involved nothing more than a moderately insulated box. The flow enthalpy is estimated from the difference signal between thermocouples located in the exhaust stream and others placed in the intake stream.

An insulated box HRR apparatus is subject to various errors associated with the finite heat losses from the system. These have been studied by several authors [5][6][7][8][9][10]. The net result was that by the early 1980s there was already a strong desire in the research community to progress to a measurement principle capable of improved accuracy, yet still within affordable cost limits to commercial testing laboratories and product manufacturers.

## The Cone Calorimeter

*The measurement principle.* The starting point for the development of the Cone Calorimeter was the then newly re-discovered principle of oxygen consumption [11][12], which was being made practical during the late 1970s and early 1980s. It became evident that the next-generation bench-scale HRR apparatus would need to be based on this measurement principle. Several years of exploratory research on various instrument designs were conducted. The successful design was termed the Cone Calorimeter and was first described by the present author in an NBS report in 1982 [13].

The Cone Calorimeter (Fig. 2) was, in fact, designed to use *only* oxygen consumption calorimetry as its measurement principle. Because of this, high reliance had to be placed on the accuracy of the oxygen measurement. This requires that a paramagnetic oxygen analyzer be used. Such analyzers are capable of an accuracy of better than  $\pm 50$  ppm  $O_2$ , with better-grade commercial analyzers achieving  $\pm 20$  ppm. In addition, it was required to develop the additional measurement system details (the layout of the gas sampling system, including desiccation, mass flow control, bypass flows, etc) to a complementary level of performance. One special feature is that because the detection principle responds to oxygen partial pressure, there needs to be a compensation for changes in atmospheric pressure.

*The heater.* After establishing the operating principle the next most important feature is the type of heater. In general, such a heater should be able to achieve adequately high irradiances, have a relatively small convective heating component, present a highly uniform irradiance over the entire exposed face of the specimen, and be designed so as not to change its irradiance when the mains voltage varies, when heater element aging occurs, or when the apparatus retains some residual heat from the exposure given to a prior specimen. For the Cone Calorimeter, a capability of providing heat fluxes up to  $100 \text{ kW m}^{-2}$  was considered essential. One of the primary requirements of the heater was that it not change the irradiance impressed on the specimen when the specimen ignites. Surprisingly, the Cone Calorimeter was the first standardized fire test apparatus ever developed to include a feedback control system for maintaining a constant specimen irradiance.

The Cone Calorimeter derives its name from the conical shape of the heater. Extensive studies showed that the shape of a truncated cone is best able to provide the high, uniform heat fluxes necessary. It was also felt necessary that the spectral distribution from the heater resemble those from real fires.

This required a high emissivity and a high view factor. Together, these allow realistic black body temperatures (*ca.* 1000 °C) to be used which correspond to those from real fires.

*Test orientation.* It was concluded that the normal orientation of the specimen should be horizontal, face up, with the heater being parallel, face down. This allows thermoplastics, liquids, and other melting or dripping samples to be successfully tested. For certain applications exploratory studies it was considered desirable to allow testing in a vertical orientation. Thus, provision was made to swing the heater by 90° into a vertical orientation. Vertical orientation testing may be preferable when it is desired to probe the flame regions, or measure specimen surface temperatures.

*Air supply and exhaust.* The air supply was provide by intake of normal room air and a special air delivery system was seen not to be necessary. Exploratory combustion studies revealed that a rate of 24 L s<sup>-1</sup> would be satisfactory. That flow rate was also about a factor of 2 greater than the minimum at which no spill out the hood occurs. The exhaust system uses a high-temperature cast iron blower to exhaust the gases and an orifice plate flowmeter. The orifice plate flowmeter is instrumented with a differential pressure transducer and a thermocouple.

*Means of ignition.* Experience in older apparatuses with non-uniform specimen heating due to ignitor effects mandated that the ignition source must not impose any additional localized heating flux on the specimen. Furthermore, the ignitor has to be designed so as not to be extinguished by fire-retardant compounds coming from the specimen, nor by air flows within the test apparatus. For this purpose, an electric spark ignitor was designed.

*Specimen holder.* To present a standardized heat flow boundary condition to the rear face of the specimen, all specimens are backed by a 13 mm layer of low-density (nominal 65 kg m<sup>-3</sup>) ceramic fiber blanket. The specimen is wrapped in a single sheet of aluminum foil, covering the sides and bottom. The aluminum foil serves to limit flow of molten material and prevent molt from seeping into the refractory blanket.

*Load cell .* Many ancillary measurements made in the Cone Calorimeter (such as the effective heat of combustion; also, yields of various gas species) require the use of a load cell. For the Cone Calorimeter, a commercial-design load cell was found which permits only up-and-down axial motion, while being insensitive to torques or forces from other directions.

*Smoke measurement.* One of the most essential ancillary measurements performed with the Cone Calorimeter is smoke obscuration. This system was devised due to widespread dissatisfaction with older, closed-box type of smoke tests [14][15]. A large number of both practical and theoretical difficulties were found with closed-box systems, and these were successfully solved by developing a flow-through smoke measuring system, using a helium-neon laser as the light source, and a sophisticated quasi-dual-beam measuring arrangement. The laser photometer is mounted on the exhaust duct, and a thermocouple is mounted nearby, since the calculations require a determination of the actual volume flow rate in the duct at the photometer location. The photometer incorporates a number of sophisticated design features, including self-purging and a quasi-dual-beam design.

*Usage and recognition.* The design of the Cone Calorimeter, as finalized, was considered a pivotal engineering invention—it was awarded the *R&D 100 Award* in 1988. It was the first-ever fire testing apparatus to be recognized by the most prestigious American award for technology innovation.

The first Cone Calorimeter built outside NIST was constructed at BRI in Japan in 1985, followed by one at the University of Gent in 1986; later in that same year 3 commercial units were built and sold in the United States. By now, some 130 units have been placed into service around the world.

*Standards.* The first standard to describe the use of the Cone Calorimeter was a draft standard issued by the American Society for Testing and Materials (ASTM) in 1986. The full standard was first issued by ASTM in 1990 under the designation "Standard Test Method for Heat and Visible Smoke Release Rates for Materials and Products using an Oxygen Consumption Calorimeter (ASTM E 1354-90)."

On the international scene, the International Organization for Standardization (ISO) had been seeking to develop a bench-scale HRR apparatus ever since the mid-1970s. Early efforts were not successful, and ISO eventually concluded that the best course of action was not to independently invent a new instrument, but to adopt the Cone Calorimeter. The international standard ISO 5660 [16] was first issued in 1993. Unlike the ASTM standard, which comprises both HRR and smoke measurement in a single document, the initial ISO standard issued was Part 1, covering only the HRR measuring portions. Smoke measurement is to be included in Part 2, which is currently in committee draft.

In the US, some more specialized standards based on the Cone Calorimeter have also recently been issued. For example, both ASTM [17] and the National Fire Protection Association (NFPA) [18] have issued standards dealing with the use of the Cone Calorimeter for testing furniture items. The US Department of Defense published a standard for composite materials [19] requiring the use of Cone Calorimeter testing. NASA issued a standard [20] based on the use of the controlled-atmospheres Cone Calorimeter for testing materials for space vehicles. In Canada, building code requirements for non-combustibility are slated to be revised, with the Cone Calorimeter being used for testing in that application. Similarly, US building codes are also starting to issue product approvals based on such testing, although so far only on a case-by-case basis.

### **The ISO 9705 room/corner test**

The main HRR method in large scale which has been standardized is the ISO 9705 [21] room/corner test (Fig. 3). This test method was derived from an earlier test promulgated by the European NORDTEST organization [22]. There is no corresponding ASTM test, even though a draft was proposed in 1982 [23]. The method entails a 2.4 x 3.6 m room, 2.4 m high. A standard door opening is prescribed. No external irradiance is used, apart from a large ignition source. While the standard itself allows certain flexibility with regards to ignition sources, in practice most of the work to date has used a single burner paradigm. This entails a 100 kW exposure for the first 10 min, followed by 300 kW for 10 subsequent min.

The test specimens are wall and ceiling linings. The normal configuration involves mounting the test product on three of the four walls (excluding the front wall) and on the ceiling. The HRR measurement is by oxygen consumption, using the same measuring technology as for the Cone Calorimeter. Extensive references on this technique have been published in [24].

### **The open-burning calorimeter**

The burning response of an item is generally not affected by room interactions until the fire is quite large. Thus, for many applications it is convenient to be able to measure the HRR of a full-scale item

under open-burning conditions. Apparatuses for doing this were developed in the early 1980s by the present author at NIST [25] and by Heskestad at Factory Mutual [26]. Conceptually, they can be viewed as a full-scale Cone Calorimeter, but without any heater. As with the room/corner test, a realistic ignition source is used to ignite the item. This depends on the commodity being tested, with different products generally requiring different types of burners. While the technology of the open-burning calorimeter is identical to the room/corner test, the costs associated with this type of testing are much lower. In addition, for many application, open-burning data are preferable to data where a room interaction effect is involved.

Neither ISO nor ASTM have a general open-burning calorimeter standard. ASTM, however, has issued standards which use these principles, but are specialized to a particular commodity. Of particular note are ASTM E 1537 [27], developed for testing upholstered furniture; and ASTM E 1590 [28], developed for testing mattresses.

### **The intermediate-scale ICAL calorimeter**

The newest apparatus in the family of oxygen-consumption based HRR apparatuses is the ICAL. This is an intermediate-scale calorimeter, recently standardized by ASTM as ASTM E 1623 [29]. This method (Fig. 4) is intended for testing complicated assemblies, where bench-scale testing might not provide sufficiently usable characterization. The specimens used here are 1 m by 1 m, and a substantial thickness can be accommodated. Unlike the Cone Calorimeter, heating is by a gas fired panel; the maximum exposure flux is  $50 \text{ kW m}^{-2}$ . Because of the geometric arrangement of the equipment, only vertical orientation testing is provided for. The oxygen consumption measuring arrangements are, again, similar to those for the Cone Calorimeter.

### **Summary**

For fire safety applications, oxygen bomb calorimetry is only rarely useful. This is primarily because items burning in real fires rarely show complete combustion, and because actual heats of combustion for many products vary with time. For such applications, by now a whole family of standardized measuring apparatuses exists. These range from the bench-scale Cone Calorimeter, to the intermediate-scale ICAL, going on to full-scale open burning calorimeters, and, finally, standardized, full-scale room fire tests. The bench-scale Cone Calorimeter has already received very widespread acceptance since its beginnings in 1982 and is viewed as an essential tool in most fire testing laboratories. The larger scale apparatuses are used somewhat less frequently (as appropriate to the higher cost of such testing). Yet these are also now well standardized and can be found in most of the better-equipped laboratories. A very large amount of fire safety engineering applications exists for such measurements, and extensive details are presented in [30].

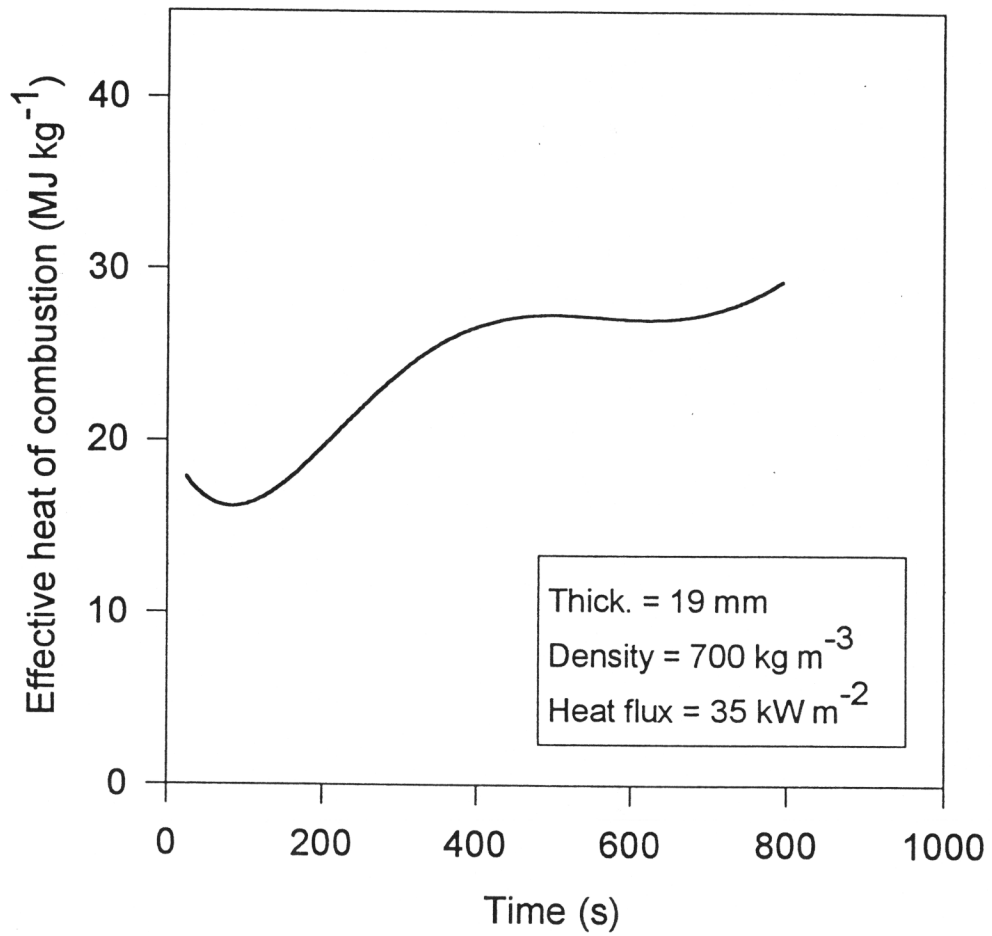
### **References**

- [1] Thompson, N.J., and Cousins, E.W., The FM Construction Materials Calorimeter, *NFPA Q.* 52, 186-192 (Jan. 1959).
- [2] Parker, W.J., and Long, M.E., Development of a Heat Release Rate Calorimeter at NBS, pp. 135-151 in *Ignition, Heat Release, and Noncombustibility of Materials* (ASTM STP 502). American Society for Testing and Materials, Philadelphia (1972).

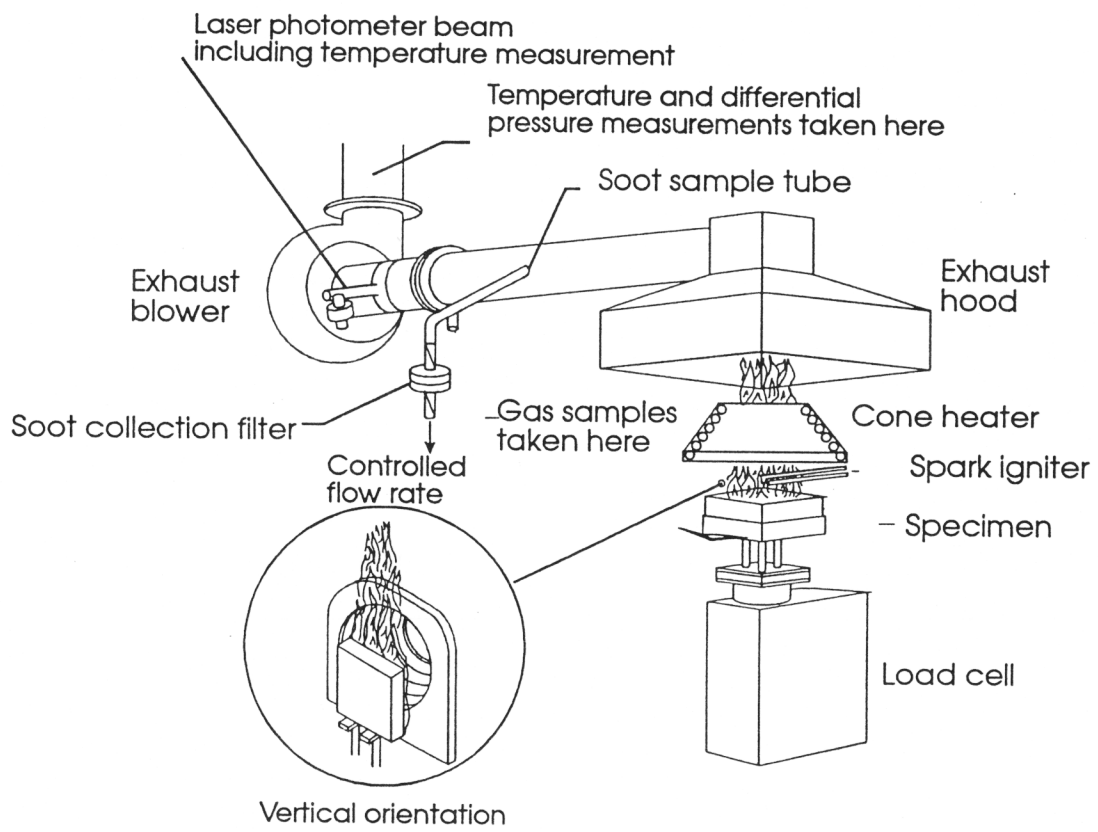
- [3] Smith, E.E., Heat Release Rate of Building Materials, pp. 119-134 in *Ignition, Heat Release and Noncombustibility of Materials* (ASTM STP 502). American Society for Testing and Materials (1972).
- [4] Test for Thermal Conductivity of Materials by Means of the Guarded Hot Plate (C 177). American Society for Testing and Materials, Philadelphia.
- [5] Krause, R.F., and Gann, R.G., Rate of Heat Release Measurements Using Oxygen Consumption, *J. Fire and Flammability*. 11, 117-130 (April 1980).
- [6] Babrauskas, V., Performance of the OSU Rate of Heat Release Apparatus Using PMMA and Gaseous Fuels, *Fire Safety J.*, 5, 9-20 (1982).
- [7] Gross, D., National Institute of Standards and Technology, private communication.
- [8] Tran, H.C., Modifications to an Ohio State University Apparatus and Comparison with Cone Calorimeter Results, AIAA/ASME Proceedings, Seattle (1990).
- [9] Blomqvist, J., RHR of Building Materials – Experiments with an OSU-Apparatus using Oxygen Consumption (Report LUTVDG/TVBB 3017). Lund Institute of Technology, Div. of Building Fire Safety and Technology, Lund, Sweden (1983).
- [10] Tsuchiya, Y., and Mathieu, J.F., Measuring Degrees of Combustibility using OSU Apparatus and Oxygen Depletion Principle, pp. 27-30 in *Intl. Conf. on Fires in Buildings*. Technomic Publ., Lancaster, PA (1989).
- [11] Parker, W. J., An Investigation of the Fire Environment in the ASTM E-84 Tunnel Test. NBS Technical Note 945. [U. S. ] Natl. Bur. Stand. (1977).
- [12] Huggett, C., Estimation of Rate of Heat Release by Means of Oxygen Consumption Measurements, *Fire and Materials* 4, 61-65 (1980).
- [13] Babrauskas, V., Development of the Cone Calorimeter A Bench-Scale Heat Release Rate Apparatus Based on Oxygen Consumption (NBSIR 82-2611). [U.S.] Natl. Bur. Stand. (1982).
- [14] Babrauskas, V., and Mulholland, G., Smoke and Soot Data Determinations in the Cone Calorimeter, pp. 83-104 in *Mathematical Modeling of Fires* (ASTM STP 983). American Society for Testing and Materials, Philadelphia (1987).
- [15] Geake, P.J., Smoke Characterisation by Laser Diffraction, Ph.D. dissertation, Polytechnic of the South Bank, London (1988).
- [16] International Standard – Fire Tests – Reaction to Fire – Part 1: Rate of Heat Release from Building Products (Cone Calorimeter method). ISO 5660-1:1993(E). International Organization for Standardization, Geneva (1993).
- [17] Standard Test Method for Determining the Heat Release Rate of Upholstered Furniture and Mattress Components or Composites Using a Bench Scale Oxygen Consumption Calorimeter (ASTM E 1474-92), American Society for Testing and Materials, Philadelphia (1992).
- [18] Standard Method of Test for Heat Release Rates for Upholstered Furniture Components or Composites and Mattresses Using an Oxygen Consumption Calorimeter (ANSI/NFPA 264A). National Fire Protection Assn., Quincy, MA (1990).
- [19] Fire and Toxicity Test Methods and Qualification Procedure for Composite Material Systems used in Hull, Machinery, and Structural Applications inside Naval Submarines, MIL-STD-2031 (SH). Department of Defense, Philadelphia, PA (1991).
- [20] Flammability, Odor, Offgassing, and Compatibility Requirements and Test Procedures for Materials in Environments That Support Combustion (NHB 8060.1C). Office of Safety and Mission Quality, National Aeronautics and Space Administration, Washington (1991).
- [21] International Standard – Fire Tests – Full scale room test for surface products. ISO 9705:1993(E). International Organization for Standardization, Geneva (1993).

- [22] Surface Products: Room Fire Tests in Full Scale (Nordtest Method NT FIRE 025). NORDTEST, Esbo, Finland (1986).
- [23] Proposed Standard Method for Room Fire Test of Wall and Ceiling Materials and Assemblies, *1982 Annual Book of ASTM Standards*, Part 18. American Society for Testing and Materials, Philadelphia (1982).
- [24] Proceedings of the International EUREFIC Seminar 1991, Interscience Communications, London (1991).
- [25] Babrauskas, V., Lawson, J. R., Walton, W. D., and Twilley, W. H., Upholstered Furniture Heat Release Rates Measured with a Furniture Calorimeter (NBSIR 82-2604). [U. S.] Natl. Bur. Stand. (1982).
- [26] Heskestad, G., A Fire Products Collector for Calorimetry into the MW Range (FMRC J. I. OC2E1. RA), Factory Mutual Research Corp., Norwood, MA (1981).
- [27] Standard Test Method for Fire Testing of Real Scale Upholstered Furniture Items (ASTM E 1537). American Society for Testing and Materials, Philadelphia (1993).
- [28] Standard Test Method for Fire Testing of Real Scale Mattresses (ASTM E 1590). American Society for Testing and Materials, Philadelphia (1994).
- [29] Standard Test Method for Determining of Fire and Thermal Parameters of Materials, Products, and Systems using an Intermediate Scale Calorimeter (ICAL), (ASTM E 1623). American Society for Testing and Materials, Philadelphia (1994).
- [30] Babrauskas, V., and Grayson, S. J., eds., **Heat Release in Fires**, Elsevier Applied Science Publishers, London (1992).

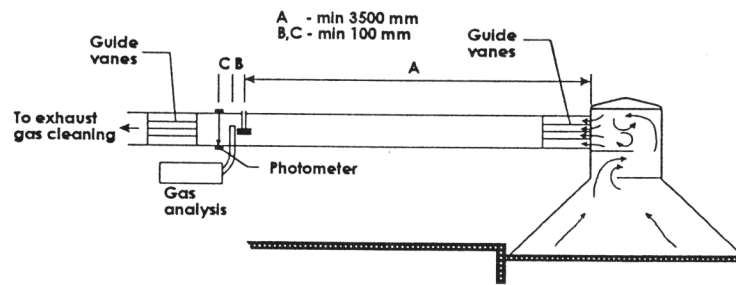
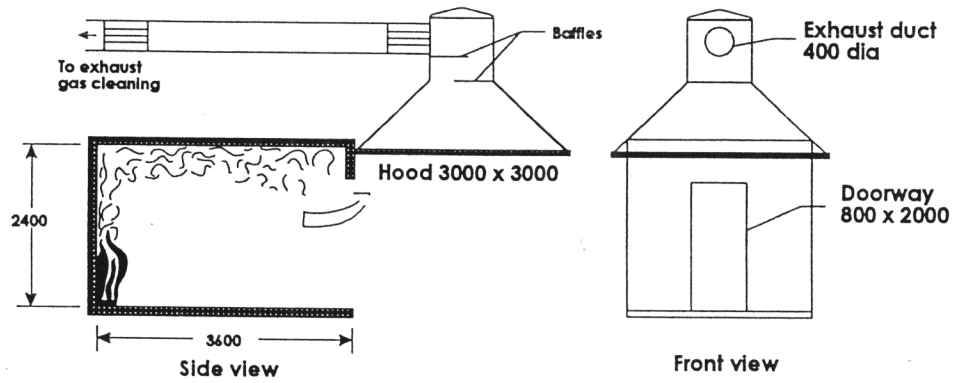




**Figure 1.** An example of a common construction material (19 mm particleboard) showing time-varying effective heat of combustion



**Figure 2.** A view of the Cone Calorimeter



All dimensions in mm.

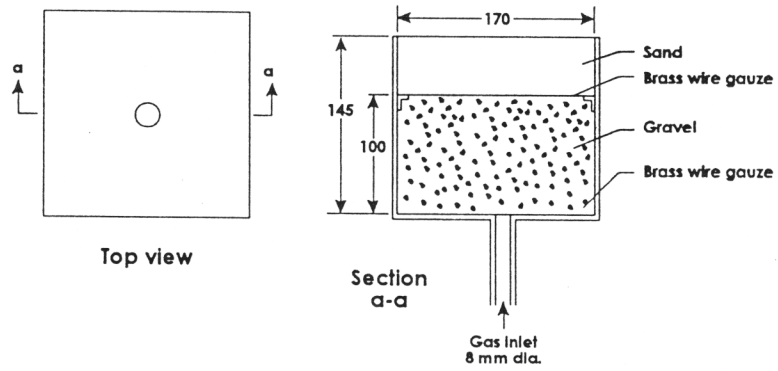


Figure 3. The ISO 9705 room/corner test

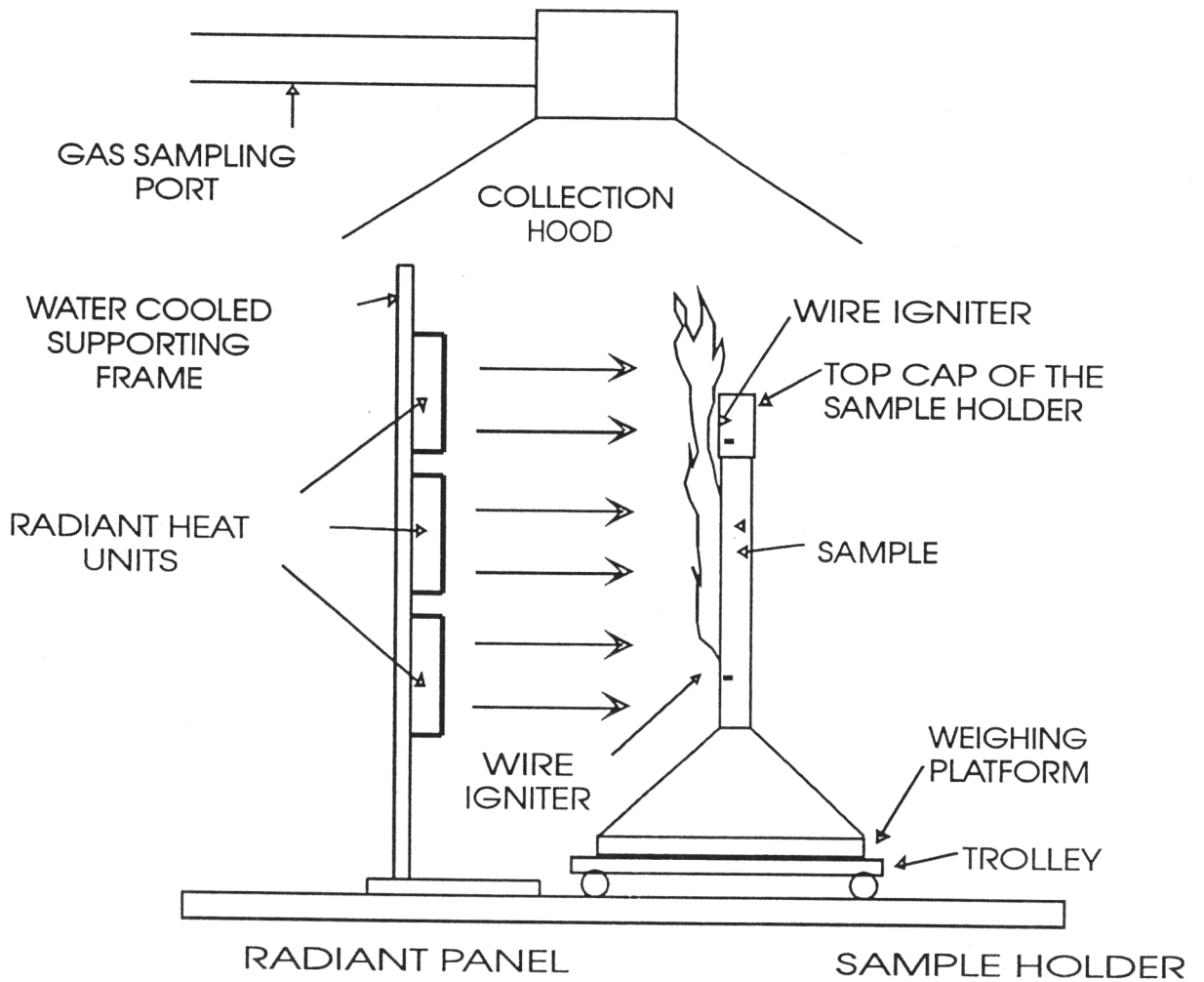


Figure 4. The ICAL intermediate-scale calorimeter

# CALORIMETRY AND FIRE ENVIRONMENT

by

Archibald Tewarson

Factory Mutual Research Corporation

1151 Boston-Providence Turnpike

Norwood, MA 02062

Calorimetry is the measurement of the quantity of heat involved in various processes. Environment is the aggregate of all natural, operational, or other conditions that affect life of organisms, the operation of equipment or component and the behavior of a physical system. In fires, heat is liberated in chemical reactions during the combustion and is defined as the *chemical heat*. The heat liberated per unit mass of a material gasified is defined as the *chemical heat of combustion*. The component of the chemical heat of combustion carried away by flowing products-air mixture is defined as the *convective heat of combustion*, and the component radiated away is defined as the *radiative heat of combustion*. In fires, combustion is rarely complete and chemical heat of combustion is some fraction of the net heat of complete combustion, defined as the *combustion efficiency*. The combustion efficiency has a convective and a radiative component.

The heat release rate is equal to the combustion efficiency (or its convective or radiative component) times the net heat of complete combustion times the mass gasification rate of the material. Calorimetric techniques have been developed to quantify the convective heat of combustion by measuring the gas temperature above ambient (Convective Heat Calorimetry) and the chemical heat of combustion by measuring: a) the consumption rate of the reactant, i.e. oxygen (Oxygen Consumption Calorimetry), and b) the generation rate of the products, i.e., carbon dioxide (Carbon Dioxide Generation Calorimetry). The Carbon Dioxide Calorimetry and its relationship with the other two calorimetries are discussed in the paper. The effects of the chemical structure of the material and additives on the chemical heat of combustion and combustion efficiency and their convective and radiative components are enumerated.

The mass gasification rate of the material is the ratio of the net heat flux received by the material to its heat of gasification. The heat flux from the flame, hot walls and ceiling and nearby burning objects, and the shape, size, and arrangement of the material affect the mass gasification rate by affecting the net heat flux. The heat of gasification is affected by the material's specific heat, melting and boiling points, heats of melting, vaporization, etc.

Fire ventilation, expressed in terms of a global equivalence ratio, affects the combustion efficiency and its convective and radiative components. Equivalence ratio is the ratio of the mass gasification rate to the mass air flow rate normalized by the mass fuel-to-air stoichiometric ratio. Fire is well-ventilated for the equivalence ratio less than unity and is ventilation-controlled for the ratio greater than unity. As the equivalence ratio increases, the combustion efficiency and its components decrease. Flame extinction occurs for combustion efficiency less than 0.40.

Heat release rate thus is equal to the combustion efficiency (or convective or radiative component) times the ratio of the net heat of combustion to the heat of gasification times the net heat flux. The chemical structure of the material and additives, flame and other heat fluxes, heat losses, and fire ventilation affect the heat release rate. These effects on the heat release rate have been investigated in detail in our studies and will be discussed in the paper.

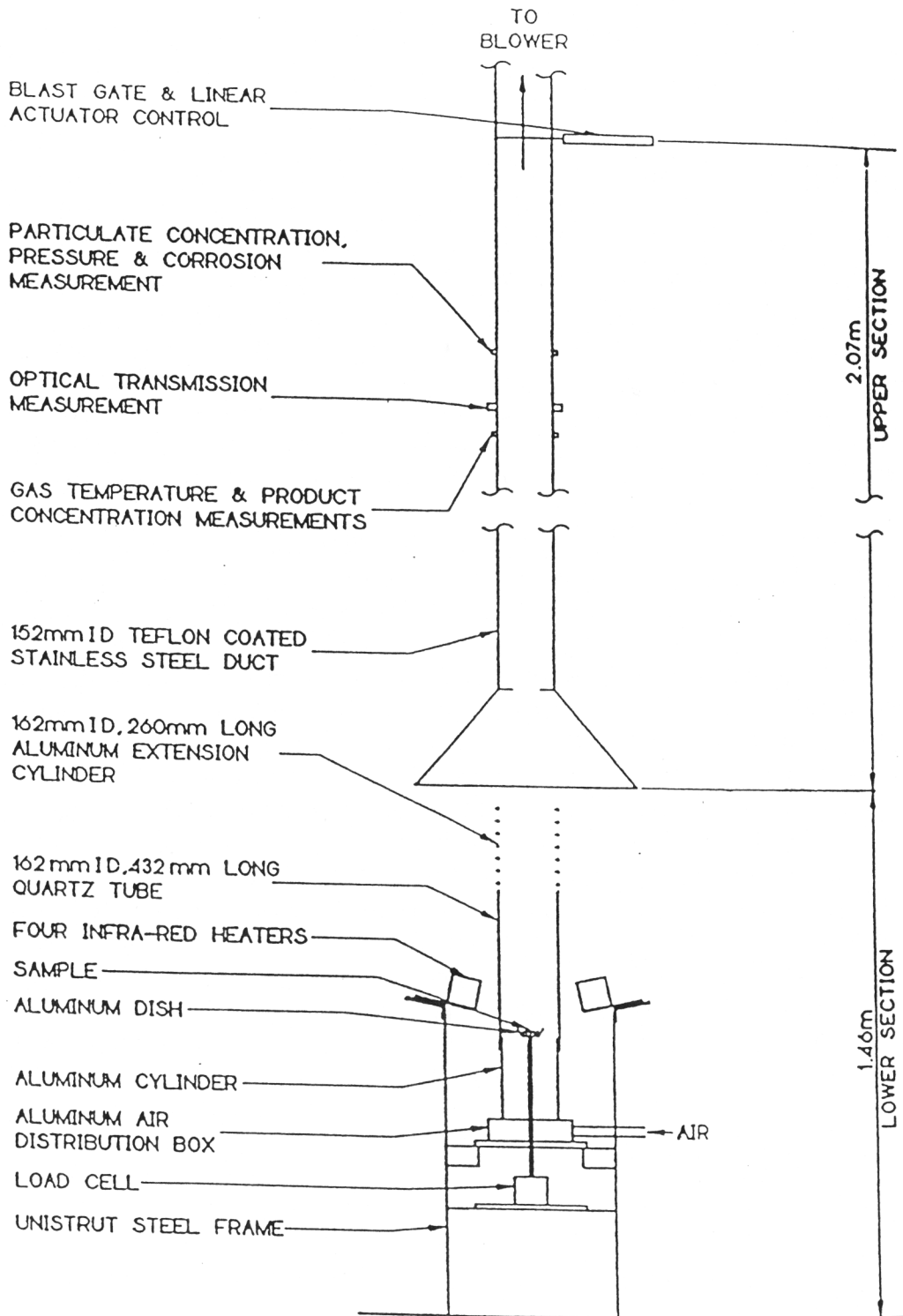


Fig. 1. The Factory Mutual Research Corporation's (FMRC) flammability apparatus (50 kW-Scale).

**Table 1****Design and Test Conditions for the  
OSU and the FMRC Apparatus and the Cone Calorimeter**

Design and Test Conditions	OSU	FMRC	Cone
Environment Gas Flow	Forced	Forced/Natural	Natural
Oxygen Concentration %	21	0-60	21
Forced Flow Gas Velocity (m/s)	0.49	0 to 0.146	NA
External Heaters	Silicon Carbide	Tungsten-Quartz	Electrical Rods
Flux (kW/m <sup>2</sup> )	0-100	0-65	0-100
Exhaust Product Flow (m <sup>3</sup> /s)	0.04	0.035-0.064	0.012-0.035
Horizontal Sample Dimensions (mm)	110 x 150	100 x 100	100 x 100
Vertical Sample Dimensions (mm)	150 x 150	100 x 600	100 x 100
Ignition	Pilot Flame	Pilot Flame	Spark Plug
Time to Ignition Measured	Yes	Yes	Yes
Surface Mass Transfer Measured	No <sup>a</sup>	Yes	Yes
Flame Spread Rate Measured	No	Yes	No
Generation Rate of Fire Products			
CO, CO <sub>2</sub> , Hydrocarbons, etc. Measured	Yes	Yes	Yes
Smoke Measured			
Light Obscuration	Yes	Yes	Yes
Optical Properties	No <sup>a</sup>	Yes	No <sup>a</sup>
Electrical Properties	No <sup>a</sup>	Yes	No <sup>a</sup>
Heat Release Rate Capacity (kW)	8	50	8
Chemical Heat Release Rate Measured	No <sup>a</sup>	Yes <sup>b</sup>	Yes <sup>c</sup>
Convective Heat Release Rate Measured	Yes <sup>d</sup>	Yes	No
Radiative Heat Release Rate Measured	No	Yes	No
Liquid and Gas Phase Corrosion Measured	No <sup>a</sup>	Yes	No <sup>a</sup>
Flame Extinction Measured	No <sup>a</sup>	Yes	No

a: can be measured; b: oxygen consumption and CO and CO<sub>2</sub> generation; c: oxygen consumption;  
d: gas temperature (some contribution by radiative heat release rate).

## THE USE OF CALORIMETRY FOR FIRE MATERIALS RESEARCH

Takashi Kashiwagi  
Center for Building and Fire Research Laboratory  
National Institute of Standards and Technology  
Gaithersburg, MD 20899

### ABSTRACT

Research to improve the fire performance of materials requires tools to measure their flammability properties and validated fire growth models to predict fire behavior of the materials in specific fire scenarios using the measured properties as inputs to the models. One of the key flammability properties is heat release rate during free-burning or radiatively-assisted burning. Since the available amount of a new experimental material is generally quite limited, a small scale calorimeter, using a small amount of a sample, is used in fire research. The currently available, small scale calorimeters such as the Cone Calorimeter are capable of measuring not only time-dependent heat release rate but also many other flammability properties. Using such a device, this presentation will describe unique trends of heat release rate, specific heat of combustion, and others flammability properties of polymeric materials as they vary with the nature of the materials.

Polymers can be divided into two categories on the basis of degradation behavior. One does not generate any char during burning, e.g., polymethylmethacrylate; the other does generate char, e.g., wood or polycarbonate. For the former type sample, heat release rate under a constant external radiant flux increases rapidly with time after ignition but this increase gradually becomes less and eventually, asymptotically heat release rate reaches a constant value. On the other hand, there are two peaks in heat release rate for char forming polymers at a continuous constant external radiant flux. One appears shortly after ignition and then the heat release rate decreases rapidly with time due to the formation of a heat insulating char layer near the sample surface. If the back side of the sample is insulated, after the thermal wave reaches there, the sample heats up more and subsequently the degradation (if the remainder of the sample is not converted to char) is accelerated and heat release rate starts to increase again until the sample is significantly consumed. Similar behavior is often observed for the heat release rate of fiber-reinforced composite materials with a non char-forming polymer resin. In this case, the polymer resin layer near the irradiated surface degrades rapidly and heat release rate increases with time. After it is consumed, glass fiber layers act as an insulation layer and also acts as a physical barrier to the transport of degradation products from below the layer to the surface. Then, heat release rate decreases with time until delamination of the glass fiber layer to expose polymer layer below the glass layer or after the thermal layer reaches the unexposed back surface.



There are many different approaches to the flame retarding of polymers such as the enhancement of char formation, addition of halogenated compounds or halogenated elements to polymer chain, the formation of an intumescent layer and the addition of a heat sink such as aluminum trihydrate. These different flame retardants generate different trends of heat release rate curves and different characteristic heat releases. For example, the addition of brominated or chlorinated flame retardant additives to polymer samples decreases heat release rate significantly at a constant external radiant flux. However, mass loss rate does not change significantly with or without the halogenated flame retardant additives. The additives decrease significantly the specific heat of combustion (heat release rate divided by weight loss rate) and total heat release but they tend to increase CO and soot yields. These trends indicate that these additives tend to suppress gas phase oxidation reactions (by scavenging radical species). Our new char-forming/enhancing additives to non char-forming polymers significantly reduce heat release rate, mass loss rate, total heat release but do not have any significant effects on specific heat of combustion and CO and soot yields. The addition of the same additives to char-forming polymers significantly increases char yield and reduces heat release rate, total heat release, mass loss rate and also specific heat of combustion.

The addition of silicone to non char-forming polymers show different trends from the addition of halogenated flame retardants or the char-forming additives. It does not generate any char but significantly reduces heat release rate and mass loss rate. However, total heat release, specific heat of combustion, and CO and soot yields do not change significantly. These samples burn less vigorously than the samples without addition of silicone but they burn longer. The formation of a thin layer near the sample surface is observed and it appears that this layer interferes with the supply of combustible degradation products to the gas phase.

Other unique cases of heat release rate will be presented. One of them is simultaneous burning of two sides over a thermally thin material when both sides are exposed to a constant external radiant flux. Generally, only one side of a sample surface is exposed to external radiation. However, it is reported that heat release rate from a thermally thin material burning on both sides is more than twice the value seen when the conventional one side is burning. This is interpreted as a consequence of the Arrhenius temperature dependence of the gasification rate of the material. Another interesting case is the effect of sample size on heat release rate for a horizontally mounted polymer sample. The comparison of heat release rate curves of polycarbonate/silicone copolymer samples (generate intumescent char) between 10 cm square, 40 cm square, and 60 cm square at external radiant flux of 30 kW/m<sup>2</sup> shows that their peak heat release rates are about the same as each other but the total heat release per unit surface area tends to be about 50% higher for the two large samples than for the 10 cm square sample. Also, sample weight losses for the two large samples at the end of a test are about 30% higher than that for the small sample.

# THE INFLUENCE OF FIRE CALORIMETRY RESULTS ON PRODUCT RESEARCH AND DEVELOPMENT ACTIVITIES

Symposium on Fire Calorimetry  
50th Calorimetry Conference  
July 23 – 28, 1995

Arthur F. Grand, Ph. D.  
Omega Point Laboratories, Inc.  
Elmendorf, TX 78112

## Abstract

The potential flammability of industrial products has an impact on product manufacturers, regulatory agencies, researchers, testing laboratories and the general public. A broad range of products come under scrutiny, including furnishings and finishings, appliance housings, thermal and electrical insulation, floor coverings, textiles, and building structural elements. These products may be natural or synthetic, homogeneous or composite, single materials or assemblies. The requirements for testing this broad array of products and applications are as diverse as the products themselves. However, several bench scale and real scale fire test methods, which are based on the principle of oxygen consumption calorimetry, can provide engineering data in order to help put the flammability of this myriad of products into perspective.

Results of fire calorimetry, or "heat release," evaluations from bench scale (e.g., the cone calorimeter, ASTM E1354), mid-scale (e.g., the intermediate scale heat release calorimeter, ASTM E1623) and real scale (e.g., a full-size upholstered furniture test method, ASTM E1537), have proven to be useful for characterizing the processes by which specimens undergo combustion. The correlations developed between bench scale and real scale results is one of the reasons for pursuing product development using this methodology.

Traditionally, the motivation behind certain product research and development activities has dictated the type of fire testing performed. However, the current emphasis on fire calorimetry as a technique for enhancing the state of the art of product development is a positive trend. The future use of fire calorimetry for product R&D may include designing polymers and fire retardant systems on the basis of bond energies; helping to develop highly fire-resistant polymer systems that may include a coating, a fire retardant additive and a high-temperature polymer; and characterization of the burning properties of unique materials and products.

## Introduction

The technology and physical capabilities exist for evaluating a variety of fire performance characteristics of many different materials and products under a wide range of actual or simulated fire scenarios. Some of the most important characteristics to be determined include heat release rate (peak, average and total), ignition delay time, mass loss rate, smoke release rate, effective heat of combustion, and release rates of toxic gases. The test methods that permit measurement of such results are sometimes called "Fire Calorimetry" methods and range in size from bench scale to real scale. Bench scale devices include the "cone calorimeter" (ASTM E1354/ISO 5660) and the "OSU" calorimeter (ASTM E906/FAR 25.853); intermediate scale apparatuses include the "ICAL" method (ASTM E1623) and the "Dial-a-Fire" calorimeter at Sandia National Laboratories; and real scale setups include several versions of room-size calorimetry methods (e.g., ASTM E1537 and ISO 9705).

These test methods have one critical item in common – they all provide for measurement of heat release rate as a function of time. This parameter is probably the single most important value for appraising the fire performance and potential fire hazard of a material or product. The bench scale and intermediate scale methods rely on the application of a controlled, external radiant heat flux to simulate the environment of an actual fire; while the real scale methods depend on a source of ignition and propagation of fire by the specimen to create the scenario. Most of the methods listed (bench scale to real scale) utilize oxygen consumption methodology for determining the heat release rate; thus minimizing the concerns over scale-up of apparatus and technique.

The potential flammability of industrial materials and products impacts on product manufacturers, regulatory agencies, researchers, testing laboratories and the general public. In fact, all of these groups could be seen as lying on a circle of product acceptability in which any of them could break the continuity.

Product manufacturers are in the business of producing products for sale. Thus, they are concerned about the potential use and misuse of their products. Also, they must meet flammability regulations in order to market many of these products. Flammability issues are one of the more important concerns for many product manufacturers.

Regulatory agencies and building code groups (federal, state or local) often set the criteria for acceptability of products according to one or more test protocols. Some of these criteria seem to be "arbitrary," while others are well thought-out and have a definitive objective. The group that sets the criteria has an obvious and substantial impact on others in the "circle."

Researchers in independent and government laboratories world-wide have been studying the reaction of materials, products and assemblies to various fire scenarios. By assessing the mechanisms of flammability performance, these researchers lend valuable insight into the development of products and the suitability of various test protocols for assessing those products.

Testing and qualification laboratories follow standard test procedures in order to categorize, rank or qualify products for their intended use. While this would seem to be a straight-forward process, the hundreds of flammability test procedures in print sometimes complicate matters, especially since many of these standards co-exist as slightly different versions under different approval agencies. In a perfect world, there would only be one test or test series needed for a given product or application with unambiguous criteria for acceptability.

The general public has heard about flammability, but generally does not appreciate the complexity of the problem. Torn between the conflicting desires of protecting loved ones from injury, while paying the lowest price available for consumer products, the public often does not know which way to turn. Sometimes, the simplest flammability tests are the easiest for the public to understand, while the more sophisticated tests that truly characterize the flammability performance of a product are more difficult to comprehend.

### The Needs for Product Development

Many products have come under scrutiny for flammability considerations. These include household or office furnishings (e.g., upholstered chairs), finishings (e.g., wall coverings), appliance housings, thermal and electrical insulation, floor coverings, textiles (for clothing, draperies and furniture), and building structural elements. These products may be natural or synthetic, homogeneous or composite, single materials or assemblies. Given the broad range of individuals and groups who are

concerned with this subject and the diversity of the products, it is not surprising that the requirements for testing are equally diverse.

Product research and development (R & D) activities may take one of several different routes to achieve the main objective of developing a product for commerce. Some companies still invest in basic, exploratory research that can lead to new products and/or new applications; however, many manufacturing companies put their resources into applied R & D, with a more specific target of product type or market penetration. Thus, product-oriented R & D is often driven by several issues in addition to product performance. For example, the following are possible motivators for product research and development activities:

- Regulatory action (e.g., public building codes and government or military regulations) can be a driving force for product development because one cannot sell into a particular market without meeting the acceptance criteria (this applies also to overseas markets). As these criteria change, different products either benefit or lose ground in that market area.
- Litigation, or the fear of litigation, is a negative motivator for product improvement; however, it is a legitimate force in the development of products for the commercial marketplace. Some companies make improvements in anticipation of possible litigation, while others make improvements afterwards.
- Insurance underwriting may be a motivator in establishing the fire performance criteria for products. The customer or specifier may request certain fire performance criteria, or the manufacturer may impose performance criteria in response to concerns about insurance coverage or potential liability.
- Public awareness of flammability issues puts pressure on manufacturers to develop and to advertise fire safe products. Many companies take pride in the development of products in advance of regulatory activity, or promotion of results that are substantially better than the minimum requirements for a given product line. Unfortunately, "advertising" sometimes takes such an important role that test results are misinterpreted or misrepresented in an effort to compare and contrast products. Approval by third parties (e.g., UL or Good Housekeeping) are sometimes used to "assure" the consumer that products have been evaluated for fire safety

- Company attitude towards the development of fire-safe products determines whether or not certain product R & D activities can go on by themselves or need a “push” from one of the outside influences. Also, the development of new, advanced products to meet more stringent fire safety demands requires foresight and commitment on the part of the R & D group.

### Utility of HRR Information

Fire calorimetry has proven itself to be a useful tool in product research & development activities. A recent book on the subject [1] covers many aspects of this technology, including descriptions of several of the test methods and utilization of the results. Evaluations of HRR data have permitted characterization of the processes by which materials undergo combustion and have led to correlations between bench scale and real scale results [e.g., 2, 3]. Also, building design criteria for fire safety may require HRR results. The utility of the results from HRR testing is a good reason for pursuing product development using this methodology.

The cone calorimeter has been particularly useful in evaluating materials for application to larger scale testing requirements because of the small specimen size required and the extensive and diverse quantity of data obtained. Larger-scale tests require “finished” products in sizes that are often not conducive to product research and development activities. For example, the following specimen sizes are required for some common larger scale test procedures: 20 in. x 24 ft. (ASTM E84); 8 ft. x 8 ft. (UBC 26-8); 30 linear yards of 54 in. wide fabric (UBC 8-2); full-size item of upholstered chair or mattress (ASTM E1537/CA T.B. 133 and ASTM E1590/CA T.B. 129, respectively). By contrast, the standard cone calorimeter specimens are 3.9 in. (100 mm) square. Thus, a manufacturer of upholstery fabric may have a great deal of difficulty in constructing a full size chair (not to mention consideration of the other parts of the composite structure); however, obtaining small pieces of fabric and foam is much more feasible. In a similar manner, a manufacturer of a fire resistant coating for wood paneling may not be able to easily prepare R & D samples that are sufficient to cover an item for ASTM E-84 tunnel testing, whereas coating a one foot square panel would provide several specimens for small scale testing.

In addition to the cone calorimeter, other calorimetry devices have utility for screening materials. The OSU calorimeter requires specimens 6 in. (150 mm) square, and the ICAL intermediate scale heat release calorimeter permits specimens that are approximately 3 ft. (1 m) square. The OSU has many of the beneficial characteristics of the cone calorimeter, except that

the procedure is generally limited to a vertical specimen orientation, does not have as high a practical heat flux range, and does not include mass loss data. Also, the thermopile measurement is different from the oxygen consumption principle on which most of the other HRR tests are based. The intermediate scale calorimeter (ICAL) has similarities to both the cone calorimeter (applied external heat flux) and the room size calorimeters (large exhaust hood). This procedure is especially suitable for specimens that exhibit "edge" effects in the cone calorimeter or that might tend to develop irregularities (e.g., fissures) in the surface during radiant heat exposure. Such specimens might not be adequately evaluated by cone calorimeter testing.

The results of bench scale testing have been useful for predicting the results of certain full scale testing procedures. The correlations obtained are sometimes empirical and therefore apply only to the types of products tested; however, research is ongoing to develop suitable results for broader correlations.

#### The Use of Calorimetry in Product R & D

Bench scale and intermediate scale calorimetry methods are presently utilized in several ways: 1) to screen products for acceptability in another (generally large scale) test protocol; 2) to compare results of new products against those obtained for another product that has already been accepted for an application; and 3) to develop heat release and gas production data for fire modeling. Real scale calorimetry methods are used primarily in the development of new test protocols (e.g., for new applications) and in the evaluation of real scale fire scenarios (often for hazard assessment).

Screening products for acceptability in another test protocol requires some insight into the processes by which products ignite and burn. Basic tenets of flammability performance include the observations that specimens burn differently when oriented horizontally or vertically and when ignited from the bottom or the top. Furthermore, specimens burn differently when exposed to an external radiant heat flux, compared to exposure only to an ignition source. While one cannot measure flame spread, as such, in the smaller scale calorimetry methods, and the specimen orientation and ignition source are fixed, the calorimetry results are conducive to calculating flammability characteristics that are different from those actually measured. Thus, flame spread can be inferred from extended treatment of the data. Many building codes require either ASTM E84 or UBC 8-2 for evaluating the potential spread of flame across the surface of a ceiling or wall material. Cone calorimeter results have been used in both of these cases to develop empirical correlations for limited groups of data.

In studies conducted in our laboratories, the cone calorimeter has been used in studies at heat fluxes ranging from 25 – 100 kW/m<sup>2</sup> for comparison of results with other devices that can expose the specimen to heat fluxes up to 200 kW/m<sup>2</sup> and with a larger surface area. Screening of specimens has also been performed for application to the ASTM E84, UBC 8-2, and California Technical Bulletin 133 test methods.

A further area for applicability of calorimetry results is in the comparison of results on new, developmental products to results already obtained for a product considered to be “acceptable” for a particular application. Related to this is the characterization of the possible effect of raw material changes on the flammability performance of a final product. The bench scale or medium scale HRR methods need not have direct applicability to the test method required for acceptance. The requirement is that sufficient testing be performed on both the proposed and the accepted product to determine similarities and differences in performance. In a recent study conducted on industrial fluids [4], the cone calorimeter was utilized for comparison of fire performance characteristics of various fluids, and for a possible extrapolation of results to other testing protocols.

The kind of results that are required for fire modeling include rates of change of mass, heat release, smoke and toxic gas evolution. This information is not available from many of the common, standard fire test methods that are published and used for acceptability of products in the marketplace. Thus, conducting these required tests will generally not permit a manufacturer to assess the potential fire hazard of the product. Calorimetry tests, however, generally provide the opportunity to obtain the information required for input into fire hazard modeling.

Real scale calorimetry methods are used primarily in the development of new test protocols and in the evaluation of real scale fire scenarios (often for hazard assessment). In a study [5] for NAGDM (National Association of Garage Door Manufacturers), real scale HRR results were used to develop a standard test method (UBC 26-8). Cone calorimeter data were obtained to complement the large scale results.

### The Future

The motivation behind certain product research and development activities has dictated the type of fire testing performed. Traditionally, these tests have consisted of open flame testing for ignitability and flame spread. The current emphasis on fire calorimetry as a technique for enhancing the



state of the art of product development is a positive trend. The future use of fire calorimetry for product R&D may include designing polymers and fire retardant systems on the basis of bond energies; helping to develop highly fire-resistant polymer systems that may include a coating, a fire retardant additive and a high-temperature polymer; and characterization of the burning properties of unique materials and products.

#### References

1. Babrauskas, V., and S. J. Grayson, Eds., "Heat Release in Fires," Elsevier Applied Science, London, 1992.
2. Proceedings of the International EUREFIC Seminar, Copenhagen, September 11-12, 1991, Interscience Communications Ltd, London, 1991.
3. Goransson, U., "Model, Based on Cone Calorimeter Results, for Explaining the Heat Release Rate Growth of Tests in a Very Large Room," Interflam '93, Interscience Communications Ltd, London, 1991, pp. 39-47.
4. Grand, A. F., and J. O. Trevino, "Flammability Screening and Fire Hazard of Industrial Fluids Using the Cone Calorimeter," to be published in Fire Resistance of Industrial Fluids, ASTM STP 1284, G. E. Totten and J. Reichel, Eds., American Society for Testing and Materials, Philadelphia, 1995.
5. Belles, D. W., "Regulating Foam Plastic Insulated Garage Doors," Presentation at SFPE Seminar "Application of Materials and Product Flammability Testing and Data in Fire Safety Design," Denver, May 23, 1995.

## MODELING FIRE GROWTH USING CALORIMETRY BENCH-SCALE DATA

Björn Karlsson, Department of Fire Safety Engineering, Lund University, Sweden.

The reaction-to-fire of products used in buildings has been a concern for legislators and authorities since the advent of building fire safety regulations. In recent years there has been ongoing an intense activity in the European countries to develop reaction-to-fire test methods and ranking systems. Some of the proposals are based on test methods which give as output certain rating terms or arbitrary numbers, other proposals are based on modern test methods, such as the Cone Calorimeter, giving as output actual or estimated flammability properties of products. There are also a number of proposals for how results from such tests should be used to rank products according to fire hazard. Most of these proposals are based on empiricism and guesswork.

One of the main reasons for the use of empiricism is the lack of development of engineering methods for calculating the important process of flame spread. It is mainly this process which determines how rapidly the fire grows and therefore, how rapidly heat and toxic gases develop.

The purpose of this presentation is to discuss such engineering methods and to emphasise the importance of using flammability properties, in conjunction with rational engineering methods, to rank products according to fire hazards.

The physical processes which are of greatest interest with regards to material hazards are those of ignition and of flame spread, especially upward (or concurrent flow) flame spread. Engineering methods for estimating ignition and lateral flame spread are well known and have been in use for some time. Such has not been the case for the process of concurrent flow flame spread, until very recently. Several groups of scientists, working separately in various countries, have developed flame spread theories which can be used in an engineering fashion to calculate upward flame spread and the resulting fire growth. These methods are of various degrees of sophistication and complexity. Some give approximate answers to specified end use scenarios, can be used by non-experts and require simple input. Others are more general, but may require expert knowledge and large amount of input data.

This paper discusses the need for developing a sound engineering philosophy for testing and ranking products with respect to fire hazard and gives certain recommendations on how to achieve this goal.

# MODELING FIRE GROWTH USING CALORIMETRY BENCH-SCALE DATA

Björn Karlsson, Department of Fire Safety Engineering, Lund University, Sweden.

## Abstract

In recent years there has been ongoing an intense activity in the European countries to develop reaction-to-fire test methods and ranking systems. Some of the proposals are based on test methods which give as output certain rating terms or arbitrary numbers, other proposals are based on modern test methods, such as the Cone Calorimeter, giving as output actual or estimated flammability properties of products. This paper discusses the need for developing a sound engineering philosophy for testing and ranking products with respect to fire hazard and gives certain recommendations on how to achieve this goal.

## 1 Introduction

The reaction-to-fire of products used in buildings has been a concern for legislators and authorities since the advent of building fire safety regulations. In recent years there has been ongoing an intense activity in the European countries to develop reaction-to-fire test methods and ranking systems. Some of the proposals are based on test methods which give as output certain rating terms or arbitrary numbers, other proposals are based on modern test methods, giving as output actual or estimated flammability properties of products. There are also a number of proposals for how results from such tests should be used to rank products according to fire hazard. Many of these proposals are based on empiricism and guesswork.

To use results from modern bench-scale tests must be seen as being advantageous to any ranking scheme. Sadly, many proposals use these results very haphazardly. A fictitious, but typical, example is given below, where a calculated index is proposed to rank materials according to flammability hazard:

$$\text{Index} = \frac{\alpha \text{THR}_{1 \text{ min}} + \beta \text{THR}_{5 \text{ min}}}{\gamma (t_{ig} q_{cr})} \quad [1]$$

Here  $THR_{1 \text{ min}}$  stands for the integrated heat release rate from ignition up to 1 minute after ignition (similar for  $THR_{5 \text{ min}}$ ),  $t_{ig}$  stands for time to ignition and  $q_{cr}$  stands for the minimum heat flux for ignition. The constants  $\alpha$ ,  $\beta$  and  $\gamma$  are then determined empirically, so that a "safe" material (such as gypsum board) gives a low index and an "unsafe" material gives a high index. It is then hoped that the materials that fall between these extremes are ranked realistically. Guesswork of the this type is clearly not desirable.

In order to devise a rational ranking system for products, which to some extent reflects the hazards encountered in a end use scenario, one must:

- 1) Define one or more end use scenario (large room, small room, ignition source, openings, etc).
- 2) Define one or more limit states or critical conditions (i.e. time until a certain gas temperature is attained, time to flashover, time until a certain concentration of gases is attained, etc).
- 3) Use knowledge of the end use conditions and limit states to define the controlling physical mechanisms involved.
- 4) Use engineering methods and simplifications in order to allow practical use of bench-scale results to estimate hazard in the end use condition.

## 2 End use scenario

Ranking materials with respect to fire safety should reflect a certain end use condition, or rather, a full scale test. There are many conceivable such scenarios:

- a small room, a large room or a corridor.
- the ignition source can be in the corner or by the wall and can be big or small.
- the material may be mounted on walls and ceilings or only on walls.
- the scenario may be well ventilated (open door) or poorly ventilated.

The end use scenario must be well defined if one wants to identify the physical processes controlling the environmental results of a fire. Why would one want to identify these processes ? Because, having identified them, one can single out the most important material parameters involved in the processes, which lead to a certain critical condition. Additionally, the importance of each of the material parameters can be assessed.

One or more well defined end use scenarios must therefore be chosen. A material can then be ranked according to each of these.

### 3 Critical conditions

There are certain critical conditions induced by fire beyond which humans are at great risk to lose their life. These conditions must be specified and quantified in order to allow identification of the processes leading towards these conditions. The conditions for human safety may for example be defined as

- a certain critical gas temperature
- a certain critical incident heat flux
- a certain concentration of CO or other gases
- a certain optical density

Other criteria have also been used, such as time to flashover in a small room. This is quite a reasonable criterion (even though human beings will not survive a flashover in a room) since it gives a measure of how quickly the fire grows and thus how quickly conditions in adjoining rooms will become hazardous to humans.

All of the above conditions depend very strongly on the end use scenario and on the Heat Release Rate (HRR), which in turn is a result of how fast the flame spreads over the material. Flame spread is in this case one of the fundamental processes since it, to a large extent, controls how fast "things" happen ("things" being heat, gases, optical density, etc).

### 4 Controlling physical processes

The physical processes which are of greatest interest with regards to material hazards are those of ignition and of flame spread, especially upward (or concurrent flow) flame spread.

The physical processes dominating upward, respectively downward flame spread are considerably different. In order to develop as simple a ranking scheme as possible, it is advantageous to consider the two processes separately, since in some end use scenarios it is clear that one of these processes will dominate.

In the first case the density differences drive the flame upwards, preheating the unburnt material mainly through flame radiation, often resulting in rapid development of heat and gases. This type of flame spread can occur not only on walls but also under ceilings.

In the second case, preheating is either dominated from an external source (e.g. a hot gas layer) or from the small tip of the flame front. This downward or lateral flame spread is often termed slow, creeping flame spread, so this process appears to

be not as hazardous as upward flame spread. However, in a room fire the walls will slowly be heated up and after a considerable time (often getting close to flashover) lateral and downward flame spread can occur very rapidly.

An example of how the two processes behave in a 1/3 scale room corner test can be seen in Figure 1. Two tests were performed where particle board was mounted on walls and ceiling in one test and the walls only in the other (Andersson [1]).

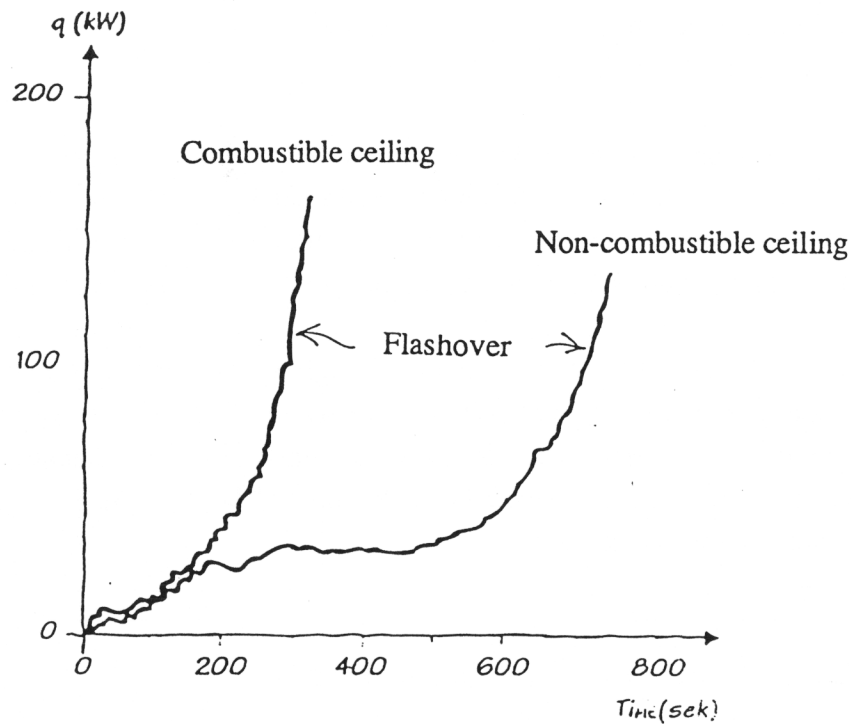


Figure 1. HRR in a room corner test with particle board mounted on walls only, and with material mounted on both walls and ceiling.

The two tests show how the HRR initially increases in both cases due to upward flame spread in the corner of the room. In the case where combustible material is only mounted on the walls, the flame spread (and HRR) is more or less halted until the hot gas layer has heated the walls sufficiently for lateral flame spread to occur, resulting in flashover after roughly 12 minutes. In the case where the material is mounted on both walls and ceiling, the concurrent flow flame spread continues directly under the ceiling, causing flashover in roughly 4 minutes.

The example shows that in many end use scenarios one would mainly be concerned with upward flame spread. This mode of flame spread is in most cases more hazardous than downward flame spread and we shall therefore look more closely at upward flame spread.

## 5 Simple engineering methods for calculating upward flame spread

Engineering methods for estimating ignition and lateral (or opposed flow) flame spread are well known and have been in use for some time. Such has not been the case for the process of concurrent flow flame spread, until very recently. The scientific work, with regards to concurrent flow flame spread, has previously concentrated on very specific geometries, requiring many input parameters and material properties data, some of which are obscure and difficult to measure.

In the last few years, however, several groups of scientists, working separately in various countries, have developed flame spread theories which can be used in an engineering fashion to calculate upward flame spread and the resulting fire growth. These methods are of various degrees of sophistication and complexity. Some give approximate answers to specified end use scenarios, can be used by non-experts and require simple input. Others are more general, but may require expert knowledge and large amount of input data.

One of the most simple approaches available is based on work on accelerating and decelerating upward flame spread, presented by Thomas and Karlsson [2] and further presented by Karlsson [3], [4]. Baroudi and Kokkala [5] used the results from Thomas and Karlsson [2] to represent the limits of accelerating and decelerating flame spread graphically, as shown in Figure 2. The figure shows results from two series of experiments, the "S" series [6] and the "E" series [7], where materials were tested in the Cone Calorimeter and in the room corner test.

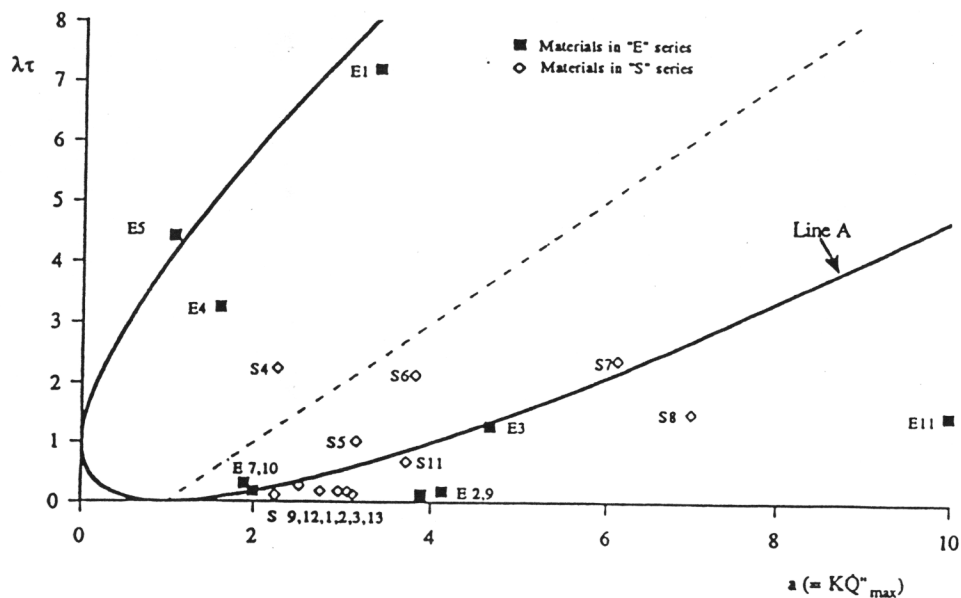
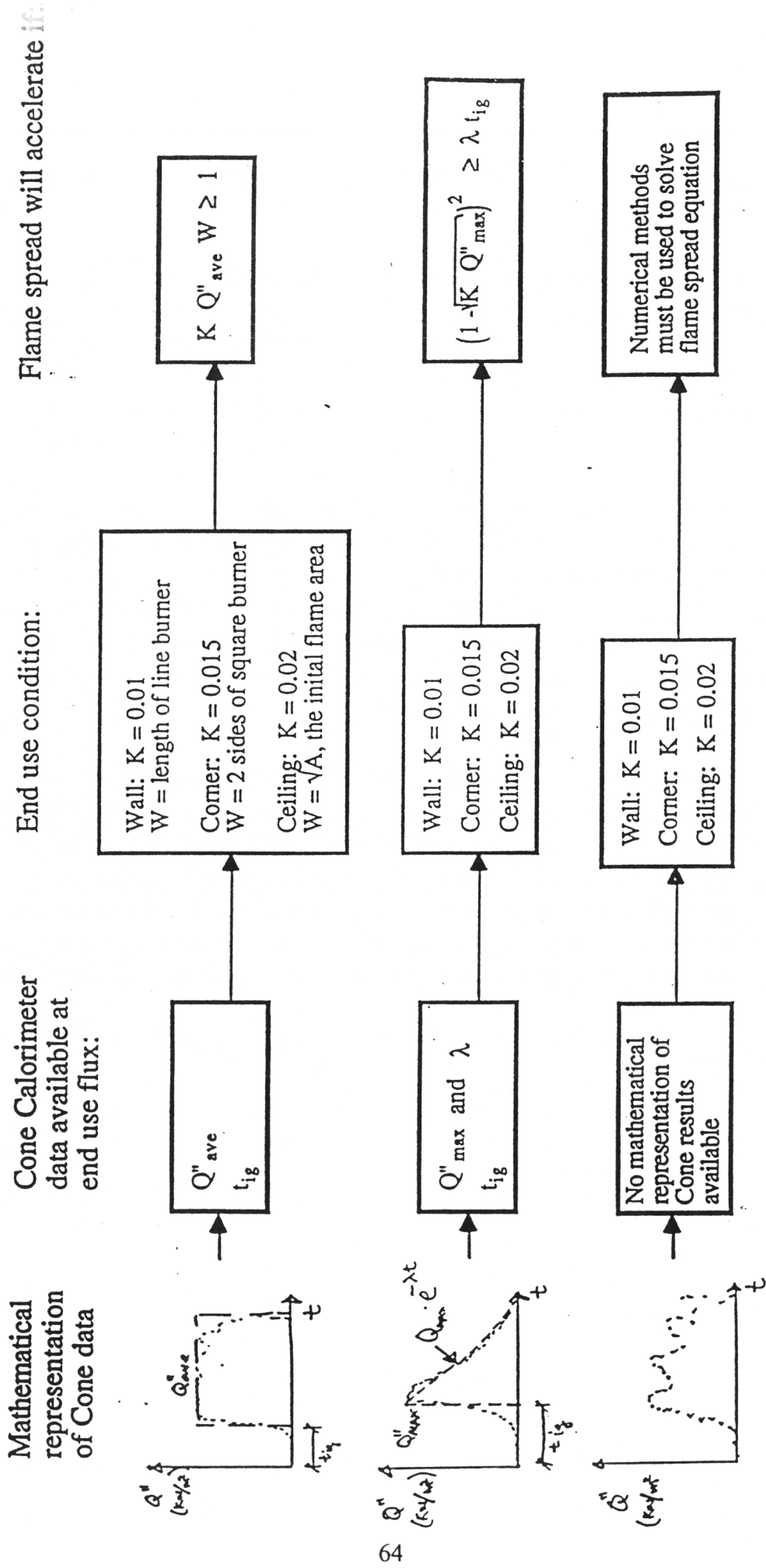


Figure 2. Results from the Cone Calorimeter used to determine flame spread propensity of 23 different surface lining materials.

Will a material exhibit acceleratory flame spread in a certain end use condition ?



$K$  = Flame height coefficient,  $W$  = Characteristic width of flame front,  $t_{ig}$  = time to ignition  
 $Q''_{ave}$ ,  $Q''_{max}$  and  $\lambda$  are mathematical representations of HRR results from the Cone Calorimeter

Figure 3. Flame spread propensity of a material in end use condition



The figure is based on data from the Cone Calorimeter. According to the flame spread theory presented by Thomas and Karlsson [2] all materials under "Line A" in the diagram exhibit accelerating flame spread. Exactly the same materials did go to flashover in the room corner tests carried out in Sweden [6], [7]. The materials just above this line are very close to going to flashover. The other materials do not show accelerating flame spread and did not go to flashover. A further discussion on this matter is given in reference [3].

The analytical solution to the flame spread equation depicted in Figure 2 is only one of many ways in which Cone Calorimeter data can be used to estimate flame spread propensity of materials. Several such schemes have been discussed recently in the literature. Figure 3 shows three of the most simple examples of how Cone Calorimeter data can be used for this purpose.

## 6 Some alternatives for ranking materials

There are an infinite number of alternatives available to authorities and industry to rank materials according to their fire hazards. Some alternatives are extremely easy to use and develop but may not reflect the actual hazard very well. Other alternatives can be too complex to use commercially but reflect the hazard well. We shall here mention three such alternatives in order to weight their applicability with their relevance to fire hazard.

Alternative A) is based more or less on guesswork. This is typical for the index method represented by equation [1]. Here, one has very little idea whether the ranking index reflects the real hazard. Guesswork can also be used by correlating time to flashover in the room corner test with certain "important" material flammability parameter. However, if no consideration is given to the controlling physical processes, one can never be certain if the right "important" material parameters have been included or not.

Alternative B) is based on isolating the dominant physical processes involved and simplifying these. As an example, the upward flame spread equations reviewed in the previous section can be used. The required input is time to ignition at the appropriate heat flux in the end use scenario, a HRR curve from the Cone Calorimeter and the flame height coefficient,  $K$ , for the appropriate end use scenario. The result is an indication of whether the material will exhibit accelerating flame spread or not in a given end use scenario. This assumes that upward flame spread is the dominating physical process involved.

Alternative C) is based on the more complex models available for calculating flame spread and HRR. For a given end use scenario and critical conditions the models can calculate time until these conditions are attained. By using Monte Carlo simulations, simple analytical regression equations can be produced and analysed. This approach can, for example, lead to a simple analytical equation for calculating time to flashover, with input from the Cone Calorimeter.

The advantages of using Alternatives C and B as opposed to Alternative A are several. Measured flammability parameters can be ranked according to importance and influence of variations in bench-scale tests can be quantified. Thus, decisions can be made on which parameters should be measured and how accurately they must be measured. Such methodologies can lead to rational classification or ranking procedures where reliability is taken into account.

## 7 Conclusion

This paper has discussed the need for developing a sound engineering philosophy for testing and ranking products with respect to fire hazard and given certain recommendations on how to achieve this goal.

One of the main reasons for the use of empiricism when ranking materials according to fire hazard is the lack of development of engineering methods for calculating the important process of flame spread. It is mainly this process which determines how rapidly the fire grows and therefore, how rapidly heat and toxic gases develop.

Using the abovementioned engineering methods to develop ranking schemes for products has several advantages.

Firstly, flammability parameters derived from bench-scale tests can be ranked according to importance, allowing decisions to be made on which parameters should be measured and which should not.

Secondly, the influence of variations in bench-scale test can be quantified and decisions made on how accurately the various parameters must be measured.

Thirdly, computer modelling uncertainties can be measured and the advantages of simplifying or adding complexities to the procedures can be quantified.

Fourthly, a ranking system with a sound bases in engineering is more likely to provide safety and economy for humans as opposed to a system based on empiricism.

## References

- [1] Andersson, B., "Model Scale Compartment Fire Tests With Wall Lining Materials", Report LUTVDG/(TVBB-3041), Department of Fire Safety Engineering, Lund University, Lund, 1988.
- [2] Thomas, P.H., Karlsson, B., "On Upward Flame Spread On Thick Fuels", Report LUTVDG/TVBB 3058, Department of Fire Safety Engineering, Lund University, Lund 1990.
- [3] Karlsson, B., "A Mathematical Model for Calculating Heat Release Rate in the Room Corner Test", Fire Safety Journal, Vol. 20, No. 2, Elsevier Applied Science, Belfast, 1993.
- [4] Karlsson, B., "Models for Calculating Flame Spread on Wall Lining Materials and the Resulting Heat Release Rate in a Room" Fire Safety Journal, Vol. 23, Elsevier Applied Science, Belfast, 1995.
- [5] Baroudi, D., Kokkala, M., "Analysis of Upward Flame Spread", VTT Publications 89, VTT, Espoo, Finland 1992
- [6] Petterson, O., "Fire Hazards and the Compartment Fire Growth Process", FoU-brand, Swedish Fire Protection Association, Stockholm, Sweden:1 1980.
- [7] Proceedings of the International EUREFIC Seminar, held in Copenhagen 11-12 September 1991, Interscience Communications Limited, London, 1991.

FIRE SUPPRESSION AND EXTINGUISHMENT  
CALORIMETRY

Jeffrey Newman  
Factory Mutual Research Corp.

## USE OF HEAT RELEASE CALORIMETRY IN STANDARDS

Marcelo M. Hirschler  
GBH International  
38 Oak Road  
Rocky River, OH, 44116-1640  
USA

Recent work has shown that heat release rate is the most important fire property, from the point of view of fire hazard assessment. This has been recognized in the rapid development of fire test standards based on heat release concepts in recent years, both within the USA and internationally. Such standards can be subdivided into four types:

- (a) generic bench-scale heat release calorimeter tests for materials;
- (b) applications bench-scale heat release calorimeter tests for products (using representative composite samples);
- (c) real-scale heat release calorimeter tests for specific products (using actual products, or real-scale mock-ups) and
- (d) guides on conduction of room-size tests containing a variety of products, and involving measurement of heat release.

In the USA, the main organizations writing fire standards are ASTM, NFPA and UL. This work describes both the standards available in 1995, and those being drafted. There are three bench-scale heat release calorimeter test apparatuses: the cone calorimeter [ASTM E1354, NFPA 264, ISO 5660], the Ohio State University apparatus [ASTM E906, NFPA 263, FAR 25.853(a-1)] and the Factory Mutual apparatus. Applications standards for the cone calorimeter started with those for upholstered furniture and mattresses [ASTM E1474, NFPA 264A: general; ASTM F1550: for vandalized upholstery in correctional facilities]. Work is in progress to develop standards for wall coverings, electric cables and non-combustible materials (or of limited combustibility). Real-scale heat release tests exist for upholstered furniture [ASTM E1537, NFPA 266, UL 1056, CA TB 133], mattresses [ASTM E1590, NFPA 267, UL 1895, CA TB 129], electric cables [ASTM D5424, ASTM D5537, UL 1685], and for decorative foam plastics [UL 1975]. Guides exist that instruct on how to conduct room fire tests [ASTM E603] and on how to use heat release standards for fire hazard assessment [ASTM E1546, ASTM D5425] and further ones are being developed for floor coverings, upholstered furniture, rail transportation and the prevention of flashover due to furnishings and contents.

## 1. INTRODUCTION

Fire hazard, defined as the potential for a fire to cause harm to people or property, results from a combination of factors including traditional fire properties like ignitability, flammability and flame spread of products, fire resistance of structural elements, smoke obscuration and toxicity, as well as more modern fire properties, such as the amount of heat released on burning, the rate of heat release and the specific conditions of the fire scenario [1].

Fire standards for most of the traditional properties have existed for a long time. For example, the first consensus fire standards developed were those for fire resistance of building construction and assemblies (ASTM<sup>1</sup> E119, issued in 1917, as ASTM C19) and of door assemblies (ASTM E152, issued in 1940 as ASTM C152). These were followed, over the decades of the 1940's through the 1970's, by the promulgation, by ASTM, of standards on flame spread (ASTM E84 and ASTM E162), fire resistance of window assemblies (ASTM E163), non-combustibility, (ASTM E136), fire retardance of roof assemblies (ASTM E108), smoke obscuration (ASTM E84 and ASTM E662), carpet critical radiant flux (ASTM E648), and standards on plastics, addressing horizontal flammability (ASTM D635), ignitability (ASTM D1929), smoke obscuration (ASTM D2843), ease of extinction (oxygen index, ASTM D2863), and specific ones for cable insulation materials, rubbers (or foams), textiles, etc.

Outside of ASTM, NFPA<sup>2</sup> has also issued consensus fire standards, many of which have been parallel to those issued by ASTM, with their own designation, over the same period. NFPA standards have appeared both before and after their ASTM counterparts, and are also characterized by including pass/fail criteria, which ASTM standards, as a rule, don't. UL<sup>3</sup> is a listing and underwriting organization, which issues its own standards for safety, many of which are associated with fire. UL has also given its own designation to many of the same standards issued by ASTM and NFPA. However, it has also issued cable fire standards, associated with large scale vertical flame spread in cable trays (UL 1581, which also has a small scale cable flame spread test) and UL 1666 and horizontal flame spread and smoke obscuration (UL 910). Vertical cable tray flame spread tests have also been issued by IEEE<sup>4</sup> (IEEE 383), CSA<sup>5</sup> (CSA C22.2 No. 0.3, FT-4) and IEC<sup>6</sup> (IEC 331-3). Internationally, a variety of fire standards were also issued by ISO<sup>7</sup>, addressing many of the same issues as the standards from the other organizations mentioned above.

---

<sup>1</sup> ASTM is the acronym for the American Society for Testing and Materials, Philadelphia, PA, USA.

<sup>2</sup> NFPA is the acronym for the National Fire Protection Association, Quincy, MA, USA.

<sup>3</sup> UL is the acronym for Underwriters Laboratories, Northbrook, IL, USA.

<sup>4</sup> IEEE is the acronym for the Institution of Electrical and Electronics Engineers, New York, NY.

<sup>5</sup> CSA is the acronym of the Canadian Standards Association, Rexdale, Ontario, Canada.

<sup>6</sup> IEC is the acronym for the International Electrotechnical Commission, Geneva, Switzerland.

<sup>7</sup> ISO is the acronym for the International Standardization Organization, Geneva, Switzerland.

The most noticeable aspect of the enumeration made above is that none of the standards described, or alluded to, includes any aspect of heat release, now acknowledged to be the most important fire property associated with fire hazard.

The first mention of heat release rate in a standard, presented as something "desirable to know" in a short section, occurred in the first edition of the "Standard Guide for Room Fire Experiments", in 1977. It was not, at that time, considered to be of great importance.

In 1983, the first consensus standard dedicated to a heat release instrument was issued by ASTM: ASTM E906, Standard Test Method for Heat and Visible Smoke Release Rates for Materials and Products, which described the apparatus known colloquially as the Ohio State University rate of heat release calorimeter (OSU RHR), because it was developed following pioneering work by Dr. Edwin Smith, of that institution [2]. This has led to the current situation, where over 30 standards addressing heat release exist, in the USA and internationally, and several new ones are under development continually.

## 2. GENERIC BENCH-SCALE HEAT RELEASE TESTS FOR MATERIALS

As mentioned before, the first standard test method for heat release issued was ASTM E906, the OSU-RHR calorimeter. It is a test method which can be used to determine the release rates of heat and visible smoke. It uses small samples (150 by 150 mm) of materials or products (maximum thickness 45 mm) exposed to different levels of radiant heat, at incident fluxes up to 100 kW/mm<sup>2</sup>, and positioned vertically. The heat source consists of a radiant panel, with four horizontal glow bars, positioned vertically across from the sample. The exposure can be conducted in the absence or presence of a pilot ignition source: a small gas burner, which can be placed so as to ignite the gases evolved by pyrolysis of the specimen or to ignite the bottom of the specimen itself. The system is a flow-through dynamic method, where heat release is determined adiabatically by means of a thermopile, by difference between thermal measurements in the exhaust smoke and in the incoming air. Smoke release is determined by an optical method, with a white light source and a photodetector above the exhaust stack (close to the thermopile). NFPA has issued a virtually identical standard, with the designation NFPA 263.

The greatest importance of the OSU RHR calorimeter, however, is that it is used as a regulatory tool by the Federal Aviation Administration, under the designation FAR 25.853(a-1). The requirements are based exclusively on heat release, and they are a peak heat release rate of 65 kW/m<sup>2</sup>, within the first 5 min of test and a total heat released of 65 kW/(min m<sup>2</sup>) within the first 2 min of test, when the incident heat flux is set at 35 kW/m<sup>2</sup>.

NBS, now NIST,<sup>8</sup> investigated ways of improving some of the known deficiencies of the OSU apparatus, mainly (a) the uneven heat flux distribution on the sample surface and (b)

---

<sup>8</sup> NBS is the acronym for the National Bureau of Standards and NIST is the acronym for its successor, the National Institute for Standards and Technology, Gaithersburg, MD, USA.

the heat losses due to lack of adiabaticity. Therefore, Dr. Vytenis Babrauskas developed the cone calorimeter [3], eventually standardized as ASTM E1354, NFPA 264 and ISO 5660 (in the ISO standard, Part 1 corresponds to heat release, while part 2 corresponds to smoke release, with the same apparatus). There are 8 main differences between the two test instruments [4]:

- (a) The cone calorimeter measures heat release by the oxygen consumption principle, while the OSU apparatus was designed as an insulated box for enthalpy flow sensing. The OSU apparatus can be modified to allow heat release measurement by oxygen consumption, but this is not used in existing standards.
- (b) Cone calorimeter samples are normally burnt horizontally, while the OSU is normally used with vertical samples. Samples can be burnt in the other orientation in either apparatus, but this may not be advisable for various reasons. Many materials melt and drip in the vertical orientation and this, along with problems of irreproducible ignition for vertical samples, has led to ASTM recommending, in ASTM E1354, to limit testing to the horizontal orientation. Vertical Testing remains a problem also for testing thermoplastic materials in the OSU. Moreover, in the OSU, the reflector used for horizontal testing leads to serious reproducibility errors in the heat flux input to the horizontal sample.
- (c) The OSU radiant source is a set of four glow bars, located directly across from the vertical sample. The cone calorimeter has a truncated conical radiant heater.
- (d) The OSU apparatus specifies one of two alternate flame igniters, while the cone calorimeter uses a spark igniter. The 'impinging pilot' used in the OSU apparatus imposes a significant local heating flux, in addition to the radiant heating flux. Thus, the thermal boundary conditions would need to be modelled differently for each a configuration. i.e. it represents a different type of fire. A fire model has been devised to use OSU data as input to produce wall lining room burns [5] and has been used for some plastic materials [6]. This model suffers from the serious problem that it was developed in the late 1970's and has not been updated properly since (moreover, it appears to be difficult to update). One problem inherent with a pilot flame, as used in the OSU apparatus, is that, at low incident heat fluxes, the flame imposes more energy than does the glow bars. This is of particular concern when testing foams destined for furniture use [7]. Another problem is that, when testing flame inhibitors which extinguish the igniter. The latter can be partially, overcome, by adding a spark igniter to reignite the flame.
- (e) The cone calorimeter apparatus includes a load cell for continuous mass measurements, while the OSU apparatus does not. Attempts have been made to build OSU units with a load cell, but test results are not widely available.
- f) The cone calorimeter uses a laser beam to measure smoke obscuration while the OSU apparatus uses a white light source. Results from both measuring systems are virtually equivalent, for small scanning times ( $\leq 3$  s [8, 9]) and smoke measurement trends have



been shown to correlate well [10, 11]. Alternative photometers can be installed in either apparatus.

- (g) The sample sizes are different: normally 100 by 100 mm in the cone and 150 by 150 mm in the OSU apparatus.
- (h) The air flow rates through the apparatus are different in the two units. They are much larger in the OSU apparatus, which makes burning much more fuel lean.

The cone calorimeter has become extremely popular, so that well over 100 units exist throughout the world. Moreover, it has spawned a number of applications standards, which will be discussed in the next section.

Another bench-scale heat release instrument exists: it was developed early on by Dr. A. Tewarson, at Factory Mutual [12-13], and it measures heat release rate based on either oxygen consumption or generation of carbon dioxide. Although it never became a consensus standard, the instrument has been widely used, and forms the basis of a requirement by Factory Mutual for its insured, for electrical cables to be used in non-combustible construction [14]. The method of carbon dioxide generation, used in this test method, is based on the concept that the energy released per molecule of oxygen consumed is approximately equal to the energy released per molecule of carbon dioxide generated, in view of the stoichiometry of the combustion reaction. Thus, the consumption rate of oxygen, the reactant, should be equal to the generation rate of carbon dioxide, the product, if combustion is complete, and they should both represent the same heat release rate. This is, in fact, also found experimentally, to a large degree. The net heat released per mass of carbon monoxide generated is also approximately constant, albeit somewhat lower than that released for carbon dioxide. If there is incomplete combustion, in this method the heat release rate determined by continuous measurement of carbon dioxide generation concentration is corrected by measuring the carbon monoxide concentration generated and subtracting the excess heat estimated. This difference is the heat of combustion per unit mass of carbon monoxide multiplied by the generation rate of carbon monoxide. Just like the needs in the cone calorimeter, for oxygen consumption calorimetry, the basic requirement of this test method is to collect and remove all combustion products in a hood and through an exhaust duct.

The test apparatus can test samples both in the horizontal orientation and the vertical orientation, within a vertical quartz tube 61 cm long. There is a radiant heat source (4 symmetrical radiant heaters), and a pre-mixed ethylene-air gas flame that serves as a pilot igniter. The flow of incident gases in this dynamic system is small enough that the oxygen concentration in the atmosphere can be adjusted both above and below the normal atmospheric level of 20.9%. This is important for the needs of the cable test, which is conducted at 40% oxygen. One disadvantage of this test method is that the heat flux distribution, which is homogeneous on horizontal samples, is focussed only on the bottom portion of the sample for vertical samples. However, it has great versatility in the type of samples it can accommodate. Just like the cone calorimeter, this test method contains a load cell, for continuous measurement of sample mass.

### 3. BENCH-SCALE HEAT RELEASE APPLICATIONS TESTS FOR PRODUCTS

Several test methods have been developed, and are being developed, which apply bench-scale heat release test methods to particular products.

The first one of such tests was the application of the cone calorimeter to upholstered furniture or mattress composites (ASTM E1474, NFPA 264A). In this test method, 50 mm thick samples are constructed, containing all layers (particularly including the cover fabric and the padding) to be expected in the product intended for test, and this composite is tested at an incident heat flux of 35 kW/m<sup>2</sup>. It has been suggested that the results from this test are, at least to some extent, predictive of the results of full scale heat release tests with the corresponding products [15-18]. There is some controversy about this, as yet, because the original predictive equation involved the 3 min average heat release rate (i.e. the average of the heat release rates between the time to ignition and the time to ignition plus 3 min): values of less than 100 kW/m<sup>2</sup> are unlikely to lead to a self-propagating fire [15-16]. However, later work suggested that the peak rate of heat release may be a better predictor [17-18], and some work has suggested that the predictability may be dependent on the materials involved, so that no generic equation would exist [19]. It is most likely, however, that heat release rates measured in the cone calorimeter will be, at least qualitatively, indicative of relative full scale heat release behavior.

In some scenarios, typically those involving detention and correctional facilities, mental health facilities and urban mass transportation, there is a significant potential for vandalism, i.e. purposeful destruction of the structure of the upholstery. Such vandalism can significantly affect the fire performance of the product, especially if the fire performance has been enhanced by the use of barriers protecting the padding, rather than by directly improving the fire performance of the padding itself. In order to deal with this problem, ASTM committee F33 (on Detection and Correctional Facilities) developed ASTM F1550, a variant of ASTM E1474, which differs from its model in that the sample has been "vandalized", in a standardized way, to expose the padding to the heat source. It has been shown that composites exist which generate virtually identical results when tested by ASTM E1474 and by ASTM F1550. On the other hand composites also exist where both tests give considerably different results, which suggests that they may be unsuitable for applications where vandalism is expected to occur with reasonable frequency, as described above.

Following the lead of the development of the application for upholstery composites, ASTM committees are in the process of generating application standards for wall covering composites and for electric cables. The draft standard for wall covering composites describes, in detail, the mounting method and requires testing at an incident heat flux of 35 kW/m<sup>2</sup>, just like for upholstery. On the other hand, the draft standard for electric cables does not prescribe a specific incident heat flux, but rather discusses some of the ways in which the results of large-scale fire tests with electrical cables can be predicted. The sample preparation requires that the exposed ends of the conductors must be sealed. The reason for this is to avoid generating artificial edge effects, resulting from gas emissions through the exposed ends rather than through the decomposed cable coatings.

A different type of application standard is one that can be used to describe materials with limited combustibility. Traditionally, a distinction was made between combustible and non-combustible materials. However, modern materials have been created, which would represent a lower fire hazard than traditional combustible materials, while at the same time not being able to qualify under the normal criteria for non-combustible materials. Therefore, at ASTM a cone calorimeter applications standard is being prepared, which creates categories of limited combustible materials, based on the rate of heat release and total heat released, at fairly high incident heat fluxes. Similar work is also being done by the model building codes, where the concept will acquire regulatory relevance.

#### 4. REAL-SCALE HEAT RELEASE TESTS FOR SPECIFIC PRODUCTS

In recent years there has been considerable activity in terms of generating test methods, based on heat release calorimetry, which address problems associated with individual products. The major areas of interest have been furnishings and contents and electrical cables.

In the area of furniture, the State of California issued two Technical Bulletins, namely TB 133 and TB 129, which detail a "Flammability Test Procedure for Seating Furniture for Use in Public Occupancies" and a "Flammability Test Procedure for Mattresses for Use in Public Buildings", respectively. These two standards are companion documents, with virtually identical procedures, which apply a gas flame to an item of furniture and determine the heat released, as well as release of smoke and combustion gases and mass loss. They have become consensus standards as ASTM E1537 and ASTM E1590, respectively. The California and ASTM test methods both allow three options for the testing environment, since it has been shown [15] that the heat released is not affected by the corresponding room dimensions, provided the peak rate of heat release does not exceed 600 kW:

- Configuration A: A test room with the following dimensions: 3.66 by 2.44 by 2.44 m (12 by 8 by 8 ft) high (ASTM room or ISO room)
- Configuration B: A test room with the following dimensions: 3.66 by 3.05 by 2.44 m (12 by 10 by 8 ft) high (California room)
- Configuration C: An open calorimeter (or furniture calorimeter).
- Alternative: Rooms of other dimensions, where it has been shown that equivalent test results are obtained.

The differences between the two methods are:

- (a) seating furniture is tested with a square burner [20] and mattresses with a T-shaped burner;
- (b) propane gas flow is 13 L/min for 80 s for seating furniture and 12 L/min for 180 s for mattresses and

- (c) the pass/fail criterion for peak rate of heat release (in the California bulletins) is 80 kW for seating furniture and 100 kW for mattresses.

These test methods have also been adopted by NFPA, with the designation NFPA 266 and NFPA 267, respectively. There is one difference, however: the NFPA standards mention only testing with a furniture calorimeter. UL has issued heat release standards for seating furniture (UL 1056) and mattresses (UL 1895), but they are significantly different from the consensus standards. Similar standards for furniture have been issued by the Scandinavian countries, and efforts are underway to generate ISO standards for heat release of furniture.

At ASTM there is an effort underway to generate another companion standard to ASTM E1537 and ASTM E1590, addressing stacked chairs. Various studies have shown that a fire involving a stack of chairs can be considerably more severe than a fire involving a single chair of the same type [21-25]. In public buildings, especially in auditoriums, or large meeting rooms, it is common to have many units of moveable furniture, which tend to be stacked vertically when not in use. Often, such stacks are 16 or more chairs high. Thus, the potential fuel load presented by such an array of stacked chairs can be significant, so that even if a single chair causes no concern, the agglomeration can create a high fire hazard. It was, therefore, felt to be very important to develop a test procedure that can determine the contribution to a fire of stacked chairs. The draft standard uses 5 chairs, and the same T burner as ASTM E1590, for 80 s, at a propane flow rate of 12 L/min. No pass/fail criteria have been developed, but preliminary studies with the draft test method have shown that extremely high heat release rates can be obtained from a stack even when the individual chair passed the California TB 133 requirement.

Electric cables are often the focus of attention, primarily because they are often present in some environments where they constitute the major fuel load. Traditional testing involved flame spread along large scale vertical cable trays. It has been shown that heat release rate can also be used as an alternative way of finding the same information. Thus, UL developed UL 1685, which adds heat release rate measurements (as well as smoke release requirements) to the standard UL 1581 (full scale) and the CSA FT-4 cable tray tests, in separate protocols within the standard. In this test 2.44 m (UL 1581) or 3.66 m high (CSA FT-4) and 300 mm wide steel trays are filled with cables and exposed to a propane gas flame of 20 kW (ca. 70,000 BTU h<sup>-1</sup>), either perpendicular to the tray (UL 1581) or at a 20° angle (CSA FT-4). The cables and tray are placed in a small compartment (2.44 by 2.44 m by 3.35 m high), with an exhaust hood in the middle, and release rates are measured in the exhaust duct. Two ASTM versions of the same test have also been developed: ASTM D5424 determines smoke emission and ASTM D5537 determines heat release, but both have the same equipment. The National Electrical Code has, so far, not been receptive to the introduction of heat release requirements, even in a descriptive capacity, in spite of several proposals having been made.

UL 910 is in the process of being drafted as an ASTM standard, and one of the major changes that is being proposed is the addition of heat release measurements, within the exhaust ducting. This is still at early stages of development.

Wall lining materials or products can be tested by room-corner testing. There are a number of such tests that have become standardized, the most important being an international standard, ISO 9705 (which has four options: walls and ceiling, with burner set at 100 and 300 kW, walls alone with burner set at 40 and 160 kW, walls alone and 100/300 kW and walls and ceiling and 40/160 kW), and two standard US tests: NFPA 265 and a proposed ASTM test. The common feature of these tests is that they deal with wall lining materials, that they assess whether the material/product is likely to cause flashover in the room and that they assess heat (and smoke) release in the exhaust duct, located outside the room doorway. Table 1 describes some of the major features of the tests (and includes also a test used by the building codes, UBC<sup>9</sup>). There is a tendency, albeit very slow, to replace the Steiner tunnel test (ASTM E84) by room-corner tests for some wall and ceiling finish materials. This has already taken place for textiles in the Life Safety Code (NFPA 101), and is gradually starting to occur for other types of wall lining materials, particularly non traditional ones.

It is worth mentioning that UL has issued several specific standards for individual product testing, probably the most widely used one being UL 1975, which tests decorative foam plastics, used for temporary exhibits, and lists them based on heat release rate criteria. Finally, ASTM E1623, recently issued, is an intermediate scale vertical calorimeter for 1 m<sup>2</sup> specimens, which can help prevent the edge effect problems inherent in small-scale tests.

The NFPA Life Safety Code (NFPA 101) introduced the concept of heat release in the assessment of upholstered furniture and mattresses, for certain applications, some 2-3 cycles ago. In the meantime, the criteria have been made stricter (from peak values of 500 kW to peak values of 250 kW), and the applicability broader. This was followed by wall finish requirements based on NFPA 265, and decorative plastics acceptability criteria based on UL 1975. The latest drafts also include proposals to incorporate ISO 9705 requirements.

## 5. GUIDES ON CONDUCTION OF ROOM SIZE TESTS

ASTM E603 is a standard guide that describes how to set up and conduct full scale room tests. As mentioned above, the original edition, in 1977, mentions heat release rate purely in passing. However, the more recent editions discuss heat release as an essential element that is involved in almost all full scale room scale testing. It discusses the issues that need to be addressed, and the precautions needed, to move ahead with heat release measurements in full scale room tests.

It is also of great interest that there is extensive work involved in developing fire hazard assessment standards, which are almost inevitably based on heat release requirements. ASTM issued ASTM E1546, as a generic guide on how to write fire hazard assessment standards, and this was shortly thereafter followed by D5425, which is the equivalent guide addressing electrotechnical products. At present three fire hazard assessment standards are under development at ASTM: (a) for floor coverings in health care occupancies; (b) for rail

---

<sup>9</sup> UBC is the acronym for the Uniform Building Code, issued by the International Conference of Building Officials, Whittier, CA, USA, and which constitutes the equivalent of building regulations for the Western States.

transportation vehicles and (c) for upholstered furniture in health care occupancies. In every case the drafts discuss small scale (materials and composites) heat release testing as well as full scale heat release tests. These drafts often include the word guide in the proposed title, to retain the impression that exact methods are still not being proposed, but rather procedures leading to better understanding of the way forward to fire hazard assessment. Of particular interest is an NFPA guide, NFPA 555, which is still in draft form, entitled "Guide on Methods for Decreasing the Probability of Flashover", which is based on the concept that flashover will be prevented if heat release can be ensured to remain low enough.

## 6. CONCLUSIONS

Heat release calorimetry has "come a long way" in a few years in the area of fire standards: from virtually no mention at all, by the end of the 1970's, it has risen to an extensive, and impressive, list of worldwide standards, which are slowly, but surely, making their way into the regulatory arena.

Once this "invasion" of codes and regulations has occurred, heat release requirements will make their way into what really affects manufacture of materials or products: commercial specifications. This is still only on the horizon, since most specifications are still based on very simplistic (and outdated) fire tests. However, the fear of product liability, among other driving forces, will cause heat release calorimetry to come to the forefront.

## 7. REFERENCES

1. Hirschler, M.M., "Heat Release from Plastics Materials", Chapter 12a, in "Heat Release in Fires", Eds. Babrauskas, V. and Grayson, S.J., Elsevier, London, UK, pp. 374-422 (1992).
2. Smith, E.E., in "Ignition, Heat Release and Noncombustibility of Materials, ASTM STP 502", (Ed. A.F. Robertson), Am. Soc. Test. Mats, Philadelphia 1972, p. 119.
3. Babrauskas, V., "Development of the Cone Calorimeter. A Bench-Scale Heat Release Rate Apparatus Based on Oxygen Consumption", Nat. Bur. Stands, NBSIR 82-2611 (1982).
4. Hirschler, M.M., "Smoke in Fires: Obscuration and Toxicity", Plenary Lecture, Business Communications Company Conference on Recent Advances in Flame Retardancy of Polymeric Materials, May 15-17, 1990, Stamford, CT, Eds. G.S. Kirshenbaum and M. Lewin, p. 70-82, Norwalk, CT, 1990.
5. Smith, E. E., and Satija, S., J. Heat Transfer, 105 281 (1983)
6. Dickens, E.D., "Use of the OSU Fire Model to Predict Corner Burn Results", Proc. Tenth Int. Conf. Fire Safety, San Francisco, Jan 1985 CA Ed C.J. Hilado.
7. Hirschler, M. M., and Shakir, S., "Comparison of the Fire Performances of various Upholstered Furniture Composites Combinations (Fabric/Foam) in Two Rate of Heat Release Calorimeters: Cone and OSU Instruments", J. Fire Sciences 9 223-248 (1991)
8. B. Östman, Int. Conf. "FIRE: Control the Heat - Reduce the Hazard," Fire Research Station, October 24-25, 1988, London, UK, paper 8.

9. E. Mikkola (VTT, Finland), First Int. Cone Calorimeter Users' Seminar and Workshop, London, UK, January 19, 1990.
10. Coaker, A.W., Hirschler, M.M. and Shoemaker, C.L., "Rate of heat release testing of vinyl power cables: Full scale cable tray tests and small scale tests", in Proc. 2nd. Int. Conf. on Electrical and Electronic Materials, Ed. C.J. Hilado, San Francisco, CA, Feb. 26-28, 1990, p. 58-84.
11. Hirschler, M.M., "The measurement of smoke in rate of heat release equipment in a manner related to fire hazard", *Fire Safety J.* 17, 239-58 (1991).
12. Tewarson, A., "Heat Release Rates from Burning Plastics", *J. Fire & Flammability* 8, 115-130 (1977).
13. Tewarson, A., "Experimental evaluation of flammability parameters of polymeric materials, Chapter 3, pp. 97-153, in "Flame Retardant Polymeric Materials", Vol. 3, Eds. M. Lewin, S.M. Atlas and E.M. Pearce, Plenum Press, New York, NY, 1982.
14. FM Class 3972, "Specification standard for cable fire propagation", Class No. 3972. Factory Mutual Research Corporation, Norwood, MA, 02062, USA, 1989.
15. Parker, W.J., Tu, K.-M., Nurbakhsh, S. and Damant, G.H., "Furniture Flammability: an investigation of the California Technical Bulletin 133 test. Part III: Full scale chair burns", NISTIR 90-4375, Natl Inst. Stands Technology, Gaithersburg, MD, 1990.
16. Babrauskas, V., "Bench-scale predictions of mattress and upholstered chair fires - Similarities and differences", NISTIR 5152, NIST Internal Report, Natl Inst. Stands Technol., Gaithersburg, MD, March 1993.
17. Hirschler, M.M., "Fire Tests and Interior Furnishings", in "Fire and Flammability of Furnishings and Contents of Buildings", ASTM STP 1233, Fowell, A.J., Ed., Amer. Soc. Testing Materials, Philadelphia, PA, 1994; pp. 7-31.
18. Hirschler, M.M., "Tools Available to Predict Full Scale Fire Performance of Furniture", in "Fire and Polymers II. Materials and Tests for Hazard Prevention" (Ed. G.L. Nelson), ACS Symposium Series 599, Developed from ACS Symp. in 208th ACS Natl Mtg, Aug. 21-25, 1994, Washington, DC, Chapter 36, pp. 593-608, Amer. Chem. Soc. Washington, DC, 1995.
19. Forsten, H.H., "Correlation of Cal 133 with Cone Calorimeter", in Proc. 20th. Int. Conf. on Fire Safety, Product Safety Corp., San Francisco (CA, U.S.A.), Ed. C.J. Hilado, Jan. 9-13, pp. 53-66 (1995).
20. T.J. Ohlemiller and K. Villa, "Furniture Flammability: an investigation of the California Technical Bulletin 133 test. Part II: Characterization of the ignition source and a comparable gas burner", NISTIR 90-4348, 1990.
21. Woolley, W.D., Raftery, M.M., Ames, S.A. and Pitt, A.I., "Behaviour of stacking chair in fire tests", *Fire International*, Vol. 6, No. 66, 66-86 (1979).
22. Paul, K.T., "Demonstration of the effect of softening and fire resistance of materials on burning characteristics", *Fire and Materials*, Vol. 4, 83-86 (1980).
23. Babrauskas, V., "Will the second item ignite?", *Fire Safety Journal*, Vol. 4, 281-92 (1981/82).
24. Irjala, B.-L., "Rate of heat release of furniture", 12th. Int. Conf. Fire Safety, Jan. 12-16, 1987, Ed. C.J. Hilado, Prod. Safety Corp., San Francisco, CA, 1987, pp. 32-43.
25. Nurbakhsh, S. and Damant, G.H., "Development of a test method for the flammability of stacking chairs", 19th. Int. Conf. Fire Safety, Jan. 10-14, 1994, Ed. C.J. Hilado, Prod. Safety Corp., San Francisco, CA, 1994, pp. 32-58.

Table 1. Comparison of Full Scale Room Corner Tests

	ASTM Proposed	NFPA 265	ISO 9705	UBC 17-5	Williamson
Room Size	8x12x8'	8x12x8'	2.5x3.7x2.5m	8x12x8'	8x12x8'
Doorway	Symmetrical, opposite central test wall				
Igniter	Gas Burner	Gas Burner	Gas Burner	Wood Crib	Gas Burner
Location	Against wall	2" off wall	Against wall	1" off wall	2" off wall
Sample	3 walls	3 walls	3 walls +	3 walls +	Wall section
Amount	ft <sup>2</sup> 256	ft <sup>2</sup> 256	Ceiling m <sup>2</sup> 36.5	Ceiling ft <sup>2</sup> 352	1'or 2' wide ft <sup>2</sup> 46
	(For Williamson at 2')				64
Testing					
Duration	15 min	15 min	20 min	15 min	15 min
Intensity					
Initial	40 kW	40 kW	100 kW	30 lb wood	40 kW
Duration	5 min	5 min	10 min	15 min	5 min
Final	160 kW	150 kW	300 kW	None	150 kW
Duration	10 min	10 min	10 min	-	10 min
Measurements					
RHR	Yes	Yes	Yes	No	Yes
Floor Flux	Yes	Yes	Yes	No	Yes
Ceiling T	Yes	Yes	Yes	No	Yes
Smoke Obsc.	Yes	No	Yes	Yes	No
CO	Yes	Yes	Yes	No	No
CO <sub>2</sub>	Yes	Yes	Yes	No	No
Visual	Yes	Yes	Yes	Yes	Yes

Comments:

UBC 17-5 requires that "inside of room" is that dimension. Other tests use a standard room, and line walls (and ceiling if needed). ISO 9705 test has other alternatives, but this is the preferred one.



## ON THE CENTRAL ROLE OF FIRE CALORIMETRY IN MODERN FIRE HAZARD ASSESSMENT

Richard W. Bukowski, P.E.

NIST, Building and Fire Research Laboratory

Gaithersburg, MD, 20899-0001

USA

Over the past two decades, fire science has evolved to the point that predictive models provide a practical means to evaluate the performance of safety systems over the range of applications regulated under law. Such evaluations take the form of fire hazard or fire risk assessments where the end points are loss of life, injury, or property damage. Numerous successful applications of these techniques to the reconstruction of accidental fires as well as quantitative validation studies have contributed to a general acceptance of these techniques.

Equally as important to the advances in this arena has been the emergence of rate-of-heat-release (RHR) as the central metric of the fire performance of materials and products for such analyses. The rate at which energy is released is the driving function which transports mass in the form of smoke and combustion gases throughout the spaces of interest, and the generation rates of these products is related directly to the RHR as well. Without the practical methods of oxygen consumption calorimetry in place today, these predictive methods would be without a means of characterizing the real performance of materials and products.

This presentation will review the role of RHR in fire hazard assessment and provide some examples of the application of RHR measurements in the reconstruction of fire incidents and in the performance evaluation of fire safety systems designs for regulatory approval.

# Defining Flashover for Fire Hazard Calculations

Richard D. Peacock and Richard W. Bukowski  
National Institute of Standards and Technology,  
Vytenis Babrauskas, Fire Science and Technology Inc.

The occurrence of flashover within a room is of considerable interest to the fire protection specialist since it is perhaps the ultimate signal of untenable conditions within the room of fire origin as well as a sign of greatly increased risk to other rooms within the building. A number of experimental studies of full scale fires have been performed that provide an adequate, but imprecise definition of flashover in terms of measurable physical properties. Computer simulations of the growth of a fire within a room are available.

## 1. A Working Definition of Flashover

Visually, flashover has been reported as a discrete event in full-scale fire tests and by the fire service in actual incidents by the terms flashover or flameover. (Backdraft is a different phenomenon.) Quantification of the flashover process in terms of measurable physical parameters, however, is not as easy to obtain. A considerable body of full-scale fire test data studying flashover exists from a variety of sources.

### 1.1 Temperature

Harmathy [1,2] presents a review of compartment fire tests and develops some theoretical predictions for comparison. For a series of full-scale compartment burnout tests, he presents average upper gas temperature rises of from 198-959°C (356-1725°F) with an average of 584°C for fully developed fires in an enclosure with a surface area of 55 m<sup>2</sup>.

Heselden [3] and Thomas and Heselden [4] report the results of an experimental study of the behavior of fully-developed fires in single compartments carried out by a number of laboratories. Gas temperatures measured centrally in the compartment a quarter of the height below the ceiling reached an average of 1070-1145°C during three different series of tests.

Hagglund, et al. [5] report that flashover defined by them as flames exiting the doorway was experimentally observed when the gas temperature about 10 mm below the ceiling reached 600°C. Babrauskas [6] applied this criterion to a series of full-scale mattress fires. Of the ten mattresses tested, only two exhibited potential to flash over the test room. These two mattress fires led to maximum gas temperatures of 938°C and 1055°C (1720°F and 1931°F).

Fang [7] reported on experiments conducted in a full-scale enclosure at NBS. An average upper room temperature ranging from 450°C to 650°C (840°F to 1200°F) provided a level of radiation transfer sufficient to result in the ignition of crumpled newspaper indicators at floor level in the compartment. The average upper room gas temperature necessary for spontaneous ignition of newsprint was 540 ± 40°C

(1004 ± 70°F). It should be noted that this average included low temperatures at the mid-height of the room and that temperatures measured 25 mm (1 in) below the ceiling in his test series almost always exceeded 600°C (1110°F).

Budnick and Klein [8-11] performed several series of tests to study the fire safety of mobile homes. During tests in the living room of a mobile home, ignition of crumpled newspaper indicators was observed with upper room temperatures ranging from 673°C to 771°C (1240°F to 1420°F). For tests where full room involvement was not noted, maximum upper room temperatures ranged from 311°C to 520°C (592°F to 968°C) [8]. Results of tests conducted in the master bedroom of a typically constructed single-width mobile home indicated peak temperatures ranging from 300°C to 375°C (572°F to 702°F) for tests where flashover was not observed and temperatures ranging from 634°C to 734°C (1173°F to 1353°F) at flashover. All temperatures reported were measured 25 mm (1 in) below the ceiling in the center of the bedroom [9].

Lee and Breese [12] report ignition of newsprint on the floor as a flashover indicator in full scale and 1/4 scale tests of submarine hull insulation at room air and doorway air temperatures of at least 650°C (1200°F) and 550°C (1020°F) respectively. For tests where flashover was not obtained, these temperatures reached a maximum of 427°C (801°F) and 324°C (615°F). They note, however, that ignition of newsprint or some designated minimum doorway or interior air temperatures are only rough indicators of flashover because of the variation in the thermal and physical properties of crumpled newsprint, the non-uniform distribution of temperatures throughout the compartment, and the differences between tests of the combined thermal radiation from the smoke, the hot air and the heated surfaces. The hot air inside the compartment usually became well mixed by the time it exited through the doorway. Thus, they concluded that doorway temperatures may be more reliable flashover indicators than interior air temperatures.

Babrauskas [13] observed flashover during a test of a urethane foam block chair resulting in maximum temperatures over 800°C (1470°F). For other tests of upholstered chairs that did not achieve flashover, temperatures were below 600°C (1110°F).

Fang and Breese [14] observed ignition of paper flashover indicators at floor level with an average upper room gas temperature of 706 ± 92°C with a 90% confidence level for a series of sixteen full-scale fire tests of residential basement rooms.

To assess the relative fire risk of cellular plastic materials as compared to wood for use in furniture Quintiere and McCaffrey [15,16] studied the burning of wood and plastic cribs in a room. They found a gap between lower temperature fires (ceiling layer gas temperature less than 450°C) and high temperature fires (ceiling layer gas temperature greater than 600°C). They measured the potential for flashover from the fact that cellulose filter paper tell-tales did indeed ignite or were destroyed in the five cases (out of sixteen) involving high gas temperatures.

Thomas [17] developed a semi-empirical calculation of the rate of heat release required to cause flashover in a compartment. He presents a simple model of flashover in a room and with it studies the influence of wall lining materials and thermal feedback to the burning items. He predicts a temperature rise of 520°C (936°F) and a black body radiation level of 22 kW/m<sup>2</sup> to an ambient surface away from the neighborhood of a burning wood fuel at the predicted critical heat release rate necessary to cause flashover. The Thomas model will be discussed in detail later.

## 1.2 Heat Flux

Heat flux to exposed items within the fire room has also been used as a criterion for the definition of flashover. Parker and Lee [18] have suggested using a level of 20 kW/m<sup>2</sup> as the heat flux at floor level at which cellulosic fuels in the lower part of the room are likely to ignite.

A range of materials tested for ignition time and fluxes are reported by Babrauskas [6]. For some common materials, the following ignition fluxes are given for a 60-second exposure:

	Flux (kW/m <sup>2</sup> )	
	Piloted	Unpiloted
Newspaper Want Ads	46	48
Box Cardboard	33	43
Polyurethane Foam	19	--

The unpiloted values are considered more appropriate for determination of full room involvement since ignition at considerable distance from the flames is involved. A value of 20 kW/m<sup>2</sup> represents, according to Smith [6,19], an unpiloted ignition time of approximately 180 seconds for box cardboard and is close to an ultimate asymptotic value.

Fang [7] found in a series of room burns that strips of newsprint placed at floor level ignited at fluxes of 17 to 25 kW/m<sup>2</sup> while 6.4 mm (1/4 in) thick fir plywood ignited at 21 to 33 kW/m<sup>2</sup>.

Budnick [8] found that, for tests in which flashover occurred, the minimum total incident heat flux at the center of the floor was 15 kW/m<sup>2</sup>.

Lee and Breese [12] report average heat fluxes at floor level of 17 to 30 kW/m<sup>2</sup> at flashover for full-scale tests of submarine compartments.

Fang and Breese [14] found good agreement between the time to ignition of newsprint flashover indicators and the time at which the incident heat flux measured at the center of the floor in the burn room reached a level of 20 kW/m<sup>2</sup> during tests in a basement recreation room.

A nominal incident floor heat flux of 20 kW/m<sup>2</sup> may be used as an indicator of the potential onset of flashover according to Quintiere and McCaffrey [15]. Ignition of filter paper flashover indicators was observed at a minimum of 17.7 kW/m<sup>2</sup> applied for roughly 200 seconds or more. Under more controlled laboratory conditions, with radiant exposure to the same target configuration, the paper charred black at 25 kW/m<sup>2</sup> and ripped at 120 seconds, but only decomposed to a brown color under 15 kW/m<sup>2</sup>.

While the researchers used different definitions for the onset of flashover, fairly good agreement was evident from a number of researchers on two criteria for the onset of flashover. A working definition, for the purpose of defining flashover in terms of measurable physical parameters would be:

Upper Gas Temperature > 600°C or  
Heat Flux at Floor Level > 20 kW/m<sup>2</sup>.

## 2. Mathematical Modeling of Fires

Considerable effort and resources have been directed at the mathematical modeling of the growth of a fire within a room from ignition to flashover. Friedman [20] and Levine [21] present overviews of the accomplishments to date. In the mid 1960's, Thomas [22] developed an approximate theory of the growth to flashover of fires in compartments. Since the late 1960's, researchers have successfully utilized the digital computer for the prediction of the various processes that take place during the growth of a fire [23]. More recently, more sophisticated models have evolved which have considered such effects as: ventilation, growth of the fire, energy feedback to the fire, turbulence, heat loss to the ceiling, and radiation induced ignitions of secondary objects within the room [20]. The Japanese Building Research Institute has used computer modeling to study radiative ignition and the spread of fire on walls and other surfaces [24,25]. Emmons and Mitler [26-31] have developed a room fire model to predict the response of a room to a fire within the room. Pape, et al [32-39], have studied the burning of furniture items within a room by computer modeling. They present burning rate curves for typical furniture items [32]. Quintiere [40] and McCaffrey [15,41] have developed a series of quasi-steady state models. Cooper [42] has applied computer modeling to estimate the time available for safe egress from a fire by coupling the detection of fire with a fire growth model to estimate untenable conditions within the room.

Certainly, one of the most comprehensive models is the Harvard University Computer Fire Code V developed by Emmons and Mitler [26-31]. This version of the mathematical model permits the computation of the development of a fire in a vented enclosure. The fire can be one of three kinds: a growing fire (ignited at a point), a pool fire, or a burner fire. The room may have up to five vents. Mass flows through the vents are calculated; species concentrations ( $\text{CO}$ ,  $\text{CO}_2$ ,  $\text{H}_2\text{O}$ ,  $\text{O}_2$ , soot) are found for the hot layer, as well as its depth, temperature, and absorptivity. The surface temperatures of up to four objects (besides the original one) can be found, and they may ignite either by piloted ignition, by radiation, or by contact with a (growing) flame. The calculation can be carried forward as far as desired. For a limited fuel mass, this means through flashover, burnout, and cooldown. No provision is yet made for the burning of walls or ceiling.

Figure 1 is an illustration of the processes occurring in a fire in a compartment with an opening in it [21,26]. The fire over the burning object generates a plume of hot gas that entrains air,  $\dot{M}_p$  from the lower layer, and adds a flux of hot, partly unburned gas,  $\dot{M}_{pg}$  to the hot ceiling layer. Early in the fire, before the ceiling layer has grown below the doorway height,  $h_d$ , air flows out the doorway to make room for the hot, lower density gas in the ceiling layer. Later, for a short time, both hot ceiling layer gas and air flow out the doorway; then as the ceiling layer approaches the thickness  $h_t$ , ceiling layer gas flows out and outside air flows in. At the neutral plane, the pressure outside and inside the room are equal. Buoyancy forces cause the pressure above the neutral plane inside the room to be greater than the outside pressure, and lower than the outside pressure below the neutral plane.

The outflow of the room ceiling layer gases is of key concern to the safety of the rest of the structure, since this is the source of smoke and toxic gases. The other rooms in the structure are generally made untenable by smoke or toxicity before they are untenable due to heat [43].

As figure 1 indicates, many processes occurring within the room interact. Thermal radiation from the fire, the hot ceiling layer, and the upper walls and ceiling affect the combustion rate (of the outside surfaces) of the burning object, and also heat up other objects in the room, shown here as a "target", until they may eventually ignite. If the flame is spreading, the rate of flame spread, as well as the rate of burning of already ignited surfaces, will be affected by the heating due to this radiation.

The plume above the fire and its entrainment of lower layer air is, of course, affected by the burning rate of the fire, which in turn is affected by the thermal radiation, the reduction of the oxygen content of the lower layer air caused by mixing between the two layers (not shown in figure 1), and drafts due to the incoming cooler air  $\dot{m}_i$ . The upper layer gases are cooled by convective and radiative heat transfer to the ceiling and upper walls, and this cooling can have a significant influence on the temperature of the upper layer, its radiation, and hence the growth rate of the fire.

Since the mathematical model must reproduce the interactions described above, where each process is affected by the other processes, it consists of a set of mathematical equations that must be solved simultaneously, usually interactively, and is only practically done on a computer.

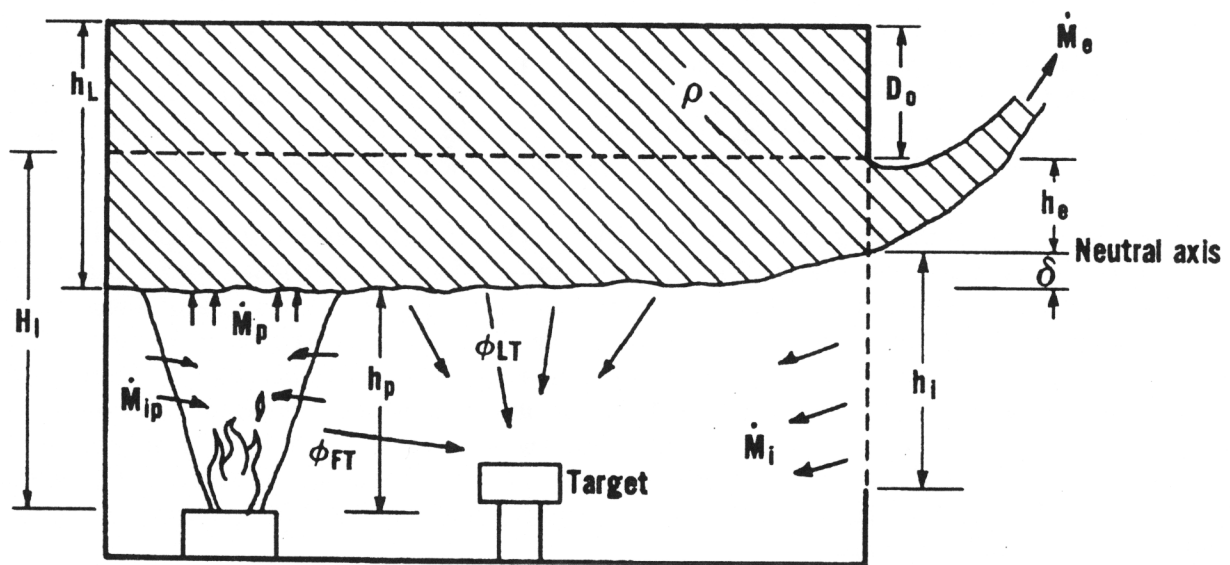


Figure 1 - Dynamics of a compartment fire leading to flashover

### 3. Estimating Room Flashover Potential

Two approaches have been taken to estimate the onset of flashover within a room. Babrauskas [44] developed a simple combustion model with a flashover criterion of  $\Delta T = 575^\circ\text{C}$  and compared the results of the predictions using the model with experimental results. He provides a simple rule to estimate the minimum heat release rate to produce flashover:

$$\dot{q} = 0.6 A(h)^{1/2}$$

where  $\dot{q}$  is the estimated rate of heat release in MW,  $A$  is the door area in  $\text{m}^2$  and  $h$  is the door height in m. The  $A(h)^{1/2}$  factor is usually called the "ventilation factor." He reports adequate agreement with experimental data with 2/3 of the data studied falling between  $\dot{q} = 0.45 A(h)^{1/2}$  and  $\dot{q} = 1.05 A(h)^{1/2}$ .

McCaffrey, Quintiere and Harkelroad [45] performed a regression analysis to provide a correlation to predict upper layer gas temperature. Using data from over 100 experiments, they found a correlation based on two dimensionless quantities:

$$\Delta T = 480 \left[ \frac{\dot{q}}{\sqrt{g} C_p \rho_o T_o A \sqrt{H}} \right]^{\frac{2}{3}} \left[ \frac{h_k A_w}{\sqrt{g} C_p \rho_o A \sqrt{H}} \right]^{-\frac{1}{3}} \text{ } ^\circ\text{C}$$

where  $\Delta T$  is the temperature rise relative to ambient in  $^\circ\text{C}$ ,  $h_k$  is the effective heat transfer coefficient to ceilings/walls,  $A_w$  is the effective surface area for heat transfer including door area,  $g$  is the gravitational constant,  $C_p$  is the specific heat of gas,  $\rho_o$  is the ambient gas density, and  $T_o$  is the initial ambient absolute temperature.  $A$  means to calculate the effective heat transfer coefficient,  $h_k$  is given in reference [39]. They report a multiple correlation coefficient of 0.959 or 0.947 depending upon whether the floor is included in the calculation of the wall area and the effective heat transfer coefficient.

By substituting typical values for  $C_p$ ,  $\rho_o$ ,  $T_o$  and a flashover criterion of  $A_T = 500^\circ\text{C}$ , the above equation can be reduced to

$$\dot{q} = 0.61 \left[ h_k A_w A (h)^2 \right]^{\frac{1}{2}}$$

where  $q$  is in MW,  $A_w$  and  $A$  are in  $\text{m}^2$ ,  $h$  is in m and  $h_k$  is in  $\text{kW}/\text{m}^2\text{K}^{-1}$ .

Thomas' flashover correlation [17] is the result of simplifications applied to an energy balance about a smoke volume contained within a compartment with a fire. The simplifications resulted in equation {1} that has a term representing heat losses to the "...total internal surface area of the compartment..." , and a term representing enthalpy flow out of the vent. The constants in equation {1} represent values correlated to experiments producing flashover.

$$\dot{Q} = 7.8 A_{room} + 378 (A_{vent} \sqrt{H_{vent}})_{equivalent} \quad \{1\}$$

$$A_{room} = A_{floor} + A_{ceiling} + A_{walls} - (A_{vents})_{equivalent} \quad \{2\}$$

$\dot{Q} =$  (kW) Fire heat release rate

$A_{vent} =$  ( $\text{m}^2$ ) the  $H_{vent} W_{vent}$ , where the  $H_{vent} W_{vent}$  can represent the dimensions of an equivalent vent defined by {3}

$$W_{vent\ equivalent} = \frac{\sum_{i=1}^n (A_{vent} \sqrt{H_{vent}})_i}{\sqrt{H_{vent\ equivalent}^3}} \quad \{3\}$$

$H_{vent, equivalent}$  = (m) the difference between the elevation of the highest point among all of the vents and the lowest point among all of the vents

$W_{vent, equivalent}$  = (m) width of a virtual vent that has an area equivalent (for the purposes of determining flashover) to the combined area of all individual vents from the room of consideration

#### 4. Limitations of Thomas' Correlation

- The formulation of the energy balance considered heat losses from the hot gas layer and heated walls to the cooler lower walls and floor surfaces. The term  $A_T$  should include all surfaces inside the room, exclusive of the vent area.
- The fire area should not be subtracted from the floor area as the fire will conduct and convect heat into the floor underneath the fuel footprint
- The equation does not know where the vent is located, nor whether the vent is a window or a door; however, the equation was developed from some tests which included window venting.
- The equation does not consider whether the walls are insulated or not. Use of the equation for compartments with thin metal walls may therefore be inappropriate
- Verification with fast growing fires: the correlation was developed from fast not slow growing fires
- The equation was correlated from experiments conducted in rooms not exceeding 16m<sup>2</sup> in floor area. Use of this equation in rooms with floor areas orders of magnitude larger is not warranted
- The equation predicts flashover in spaces without ventilation which is unlikely due to oxygen starvation of the fire.
- The experiments included compartments with thermally thick walls and fires of wood cribs. The equation was later verified in gypsum lined rooms with furniture fires [18].



## 5. References

1. Harmathy, T.Z., A New Look at Compartment Fires, Part I, *Fire Technology*, 8, 3, pp 196-217, 1972.
2. Harmathy, T.Z., A New Look at Compartment Fires, Part II, *Fire Technology*, 8, 4, pp 326-351, 1972.
3. Heselden, A.J.M., Results of an International Cooperative Program on Fully-developed Fires in Single Compartments. Fire-resistive Requirements for Buildings -- A New Approach, Symposium No. 5, 2-13, *Proc. of the Joint Fire Research Organization*, London, September 28, 1971, 1973.
4. Thomas, P.H. and Heselden, A.J.M., Fully-developed Fires in Single Compartments, A Cooperative Research Program of the CIB, Fire Research Note No. 923, Fire Research Station, Borehamwood UK, 1972.
5. Hagglund, B., Janson, R., and Onnermark, B., Fire Development in Residential Rooms After Ignition from Nuclear Explosions, FOA C20016-DG (A3), Forsvarets Forskningsanstalt, Stockholm, 1974.
6. Babrauskas, V., Combustion of Mattresses Exposed to Flaming Ignition Sources, Part I, Full-scale Tests and Hazard Analysis, Nat. Bur. Stand. (U.S.), NBSIR 77-1290, 1977.
7. Fang, J.B., Fire Buildup in a Room and the Role of Interior Finish Materials, Nat. Bur. Stand. (U.S.), TN 879, 1975.
8. Budnick, E.K., Mobile Home Living Room Fire Studies: The Role of Interior Finish, Nat. Bur. Stand. (U.S.), NBSIR 78-1530, 1978.
9. Budnick, E.K., Klein, D.P., and O'Laughlin, R.J., Mobile Home Bedroom Fire Studies: The Role of Interior Finish, Nat. Bur. Stand. (U.S.), NBSIR 78-1531, 1978.
10. Klein, D.P., Characteristics of Incidental Fires in the Living Room of a Mobile Home, Nat. Bur. Stand. (U.S.), NBSIR 78-1522, 1978.
11. Budnick, E.K. and Klein, D.P., Mobile Home Fire Studies: Summary and Recommendations, Nat. Bur. Stand. (U.S.), NBSIR 79-1720, 1979.
12. Lee, B.T. and Breese, J.N., Submarine Compartment Fire Study - Fire Performance Evaluation of Hull Insulation, Nat. Bur. Stand. (U.S.), NBSIR 78-1584, 1979.
13. Babrauskas, V., Full-Scale Burning Behavior of Upholstered Chairs, Nat. Bur. Stand. (U.S.), TN 1103, 1979.
14. Fang, J.B. and Breese, J.N., Fire Development in Residential Basement Rooms, Nat. Bur. Stand. (U.S.), NBSIR 80-2120, 1980.

15. Quintiere, J.G. and McCaffrey, B.J., The Burning of Wood and Plastic Cribs in an Enclosure: Volume I, Nat. Bur. Stand. (U.S.), NBSIR 80-2054, 1980.
16. McCaffrey, B.J. and Rocket, J.A., Nat. Bur. Stand. (U.S.), *J. Res.*, 82, 2, pp 107-117, 1977.
17. Thomas, P.H., Testing Products and Materials for Their Contribution to Flashover in Rooms, *Fire and Materials*, 5, pp 103-111; 1981.
18. Parker, W.J. and Lee, B.T., Fire Build-Up in Reduced Size Enclosures. In: Fire Safety Research, Proc. of a Symposium Held at the NBS, Gaithersburg, MD on August 22, 1973. M.J. Butler and J.A. Slater, eds. Nat. Bur. Stand. (U.S.), NBS SP-411, pp 139-53 (1974).
19. Smith, W.K., Naval Weapons Center, China Lake (unpublished reports).
20. Friedman, R., Status of Mathematical Modeling of Fires, Factory Mutual Research Corporation, FMRC RC81-BT-5 (1981).
21. Levine, R.S., Mathematical Modeling of Fires, Nat. Bur. Stand. (U.S.), NBSIR 80-2107 (1980).
22. Thomas, P.H., Theoretical Considerations of the Growth to Flashover of Compartment Fires, Fire Research Note No. 663, Fire Research Station, Borehamwood (1967).
23. Torrance, K.E. and Rockett, J.A., Experiments on Natural Convection in Enclosures with Localized Heating from Below, *J. Fluid Meth.*, 36, 1, 33-54 (1969).
24. Tanaka, T., A Mathematical Model of a Compartment Fire, Building Research Institute (Japan), BRI Research Paper #70 (1977).
25. Hasemi, Y., Numerical Simulation of Fire Phenomena and Its Application, Building Research Institute (Japan), BRI Research Paper #66 (1976).
26. Mitler, H.E., The Physical Basis for the Harvard Computer Fire Code, Home Fire Project Technical Report #39, Harvard University, Division of Engineering and Applied Science (1978).
27. Mitler, H.E., User's Guide for the Harvard Computer Fire Code, Home Fire Project Technical Report #37, Harvard University, Division of Engineering and Applied Science (1979).
28. Emmons, H.W., Computer Fire Code (II), Home Fire Project Technical Report #20, Harvard University, Division of Engineering and Applied Science (1977).
29. Emmons, H.W., The Prediction of Fires in Buildings, 17th Int. Symp. on Combustion, 1101-1113, The Combustion Institute, Pittsburgh, PA (1979).
30. Emmons, H.W., Scientific Progress on Fires, *Ann. Rev. Fluid Mech.* 1980, 12, 223-236 (1980).
31. Emmons, H.W., The Calculation of Fire in a Large Building, ASME 20th Natl. Heat Transfer Conf., Milwaukee, WI (1981).

32. Pape, R., Waterman, T.E., and Eichler, T.V., Development of a Fire in a Room from Ignition to Full Room Involvement -- RFIRES, contract to Nat. Bur. Stand. (U.S.), NBS GCR 81-301 (1981).
33. Pape, R., Preflashover Room Fire Model: Parametric Sensitivity Analysis and Development of a Submodel for Burning Furniture Items, contract to Nat. Bur. Stand. (U.S.), NBS GCR 81-300 (1981).
34. Pape, R., Mavec, J., Kalkbrenner, D., Waterman, T., Program Documentation and User's Guide - Semistochastic Approach to Predicting the Development of a Fire in a Room from Ignition to Flashover - RFIRES, contract to Nat. Bur. Stand. (U.S.) NBSGCR 77-111 (June 1976).
35. Pape, R. and Waterman, T., Program Documentation and User's Guide (Addendum) - Semistochastic Approach to Predicting the Development of a Fire in a Room from Ignition to Flashover - RFIRES, contract to Nat. Bur. Stand. (U.S.), NBSGCR 77-112 (1976).
36. Waterman, T. and Pape, R., A Study of the Development of Room Fires, contract to Nat. Bur. Stand. (U.S.), NBSGCR 77-110 (September 1976).
37. Pape, R. and Waterman, T., Modifications to the RFIRES Preflashover Room Fire Computer Model, contract to Nat. Bur. Stand. (U.S.), NBSGCR 77-113 (March 1977).
38. Pape, R., Computer Simulation of Full-Scale Room Fire Experiments, Illinois Institute of Technology Research Institute, Final Report J6414 (March 1978).
39. Pape, R. and Waterman, T., "Understanding and Modeling Preflashover Compartment Fires," *Design of Buildings for Fire Safety*, ASTM STP 685, E.E. Smith and T.Z. Harmathy, eds., American Society for Testing and Materials, pp 106-138 (1979).
40. Quintiere, J.G., Growth of Fire in Building Compartments, ASTM Special Publication 614, A.F. Robertson, ed., pp 131-167 (1977).
41. Quintiere, J.G., Steckler, K., and McCaffrey, B.J., A Model to Predict the Conditions in a Room Subject to Crib Fires, Proceedings of the Fire Specialists Meeting of the Combustion Institute, Bordeaux, France (July 20-24, 1981).
42. Cooper, L.Y., Estimating Safe Available Egress Time from Fires, Nat. Bur. Stand. (U.S.), NBSIR 80-2172 (1981).
43. Friedman, R., Quantification of Threat from a Rapidly Growing Fire in Terms of Relative Material Properties, *Fire and Materials*, 2, 1, 27-33 (1978).
44. Babrauskas, V., Estimating Room Flashover Potential, *Fire Technology*, 16, 2, 94-103 (1980).
45. McCaffrey, B.J., Quintiere, J.G. and Harkleroad, M.F., Estimating Room Temperatures and the Likelihood of Flashover Using Fire Data Correlations, *Fire Technology*, 17, 2, 98-119 (1981).

THERMAL MEASUREMENTS IN FIRE SAFETY TESTING  
ARE WE PLAYING WITH FIRE?

Ned Keltner - Senior Engineer - Ktech Corporation - Albuquerque, New Mexico

By today's standards, early fire response tests were somewhat qualitative and interpretation of the results was often based on comparisons to performance in accidental fires. As fire calorimetry has developed, tests and comparisons have become more quantitative. Fire calorimetry data is being used in models to predict the reaction-to-fire of full scale fires. Both fire calorimetry and full scale, reaction-to-fire tests have become more quantitative to support these efforts and the number of measurements have increased.

In both the standards arena and in R&D, the experiments are portrayed as a sort of absolute. The feeling is that what happens (as described by our measurements) is what happens. Making accurate measurements in any type of test is a difficult problem. An application measurement is different from a laboratory or calibration measurement, because the conditions in the application can affect the accuracy of the measurement. The problem is especially difficult in fire safety testing because there are so many different, nonlinear phenomena that can affect the measurements.

As more quantitative data is required, concerns about two types of measurement problems are growing. As conditions in the application and the calibration environments diverge, systematic errors can significantly increase measurement uncertainty. Application errors are steady state and transient errors that can occur due to improper transducer selection, poor installation or use techniques, and inadequate data acquisition system capabilities. Errors of up to 50% or more can result from these types of problems.

Temperatures and heat fluxes are two important parameters that are measured and/or controlled in fire calorimetry. Thermocouples are perceived as easy to use and thus easy to understand sensors. In reality, the thermocouple acts like a very complex balance. The problems stem from the fact that the thermocouple output is generally indicative of the thermocouple temperature and not the temperature of interest, be it fire or surface. The Gardon gage can be used to illustrate heat flux measurement problems. The overall effect of a variety of potential calibration and application problems can take a sensor that has a specified accuracy of +/- 3% (ASTM Standard E511) and provide a measurement that has an uncertainty as large as +25% and -50%. This is obviously not desirable.

As noted above, measurement are often considered to be the standard against which we should compare our models. Unfortunately, it is as easy to lie with measurements (especially in fires) as it is to lie with statistics; it is just not as obvious. The basic effect is called **MEASUREMENT MAGIC**. In this type of illusion, the sensor appears to be giving a correct reading or at least one that agrees with your intuition. ( Before the modelers point their fingers and say I told you so, remember there is a corresponding form of illusion called **MODEL MAGIC**. However, that's another story.) The presentation will provide examples of how Measurement Magic can creep into an experiment and techniques to identify and eliminate it.

## THERMAL MEASUREMENTS IN FIRE SAFETY TESTING-ARE WE PLAYING WITH FIRE?

Ned Keltner - Senior Engineer - Ktech Corporation - Albuquerque, New Mexico

Standardized fire response test methods have been used to evaluate materials and assemblies since the early 1900's in a successful effort to improve fire safety. Early tests were somewhat qualitative (at least by today's standards) and interpretation of the results was based in part on comparing the performance in tests to that in accidental fires. Performance comparisons between materials are still used as part of the evaluation of fire response test data. As fire calorimetry has developed, these comparisons have become more quantitative. Fire calorimetry data are being used in the models to predict the reaction-to-fire in simulations of full scale, accidental fires. As a result, both fire calorimetry and full scale, reaction-to-fire tests have become more quantitative to support these efforts and the number of measurements have increased.

In both the standards arena and in the interplay between the models and the experiments, the experiments are portrayed as a sort of absolute. The feeling is that what happens (at least, as described by our measurements) is what happens. Making accurate measurements in any type of test is a difficult problem and requires a significant effort. An application measurement is different from a laboratory or calibration measurement, due to the need to understand how the conditions in the application can affect the accuracy of the measurement. The problem is especially difficult in fire safety testing because there are so many different phenomena that can affect the measurements. A partial list includes flames, chemical reactions, all three types of heat transfer (radiation-convection-conduction), smoke, and condensation.

As a result of the need for more quantitative data to support fire modeling, concerns about two types of potentially serious measurement problems are growing. These are:

1. Calibration Related Problems - Sensors are calibrated in a precise fashion, usually under static conditions. However, errors can result when a sensor is used in a manner that is different from the calibration method. The fidelity of the measurement process is highest when the application environment closely replicates the calibration environment. As the two diverge, there is the potential for systematic errors to increase and significantly increase measurement uncertainty.
2. Application Related Problems - These are steady state and transient errors that can occur due to improper transducer selection, poor installation or use techniques, and inadequate data acquisition system capabilities. Errors of up to 50% or more can result from these types of problems. The effects of these problems have been highlighted by different efforts, such as the heat flux gage calibration round robin sponsored by the FAA Tech Center and the round robin evaluation of fire standards, such as the Room Burn, the Cone Calorimeter, and the OSU Rate of Heat Release Device, sponsored by ASTM's Institute for Standards Research.

Temperatures and heat fluxes are two important parameters that are measured and/or controlled in fire calorimetry. Temperatures and heat fluxes in thermal tests are comparable to voltages and currents in electrical circuits. Unlike their electrical counterparts, the science of making these thermal measurements is not as advanced.

Thermocouples are the most common thermal instrument used in fire response tests. They are cheap, rugged, and deceptively simple - just a pair of wires. Because they consist of just a pair of wires, thermocouples are perceived as easy to use and thus easy to understand sensors. In reality, the thermocouple acts like a very complex balance. As depicted in Figure 1, the thermocouple reading accounts for all of the factors that influence it. In a fire (or a furnace) temperature measurement, the list of phenomena that can influence the measurement includes the size of the thermocouple, its orientation, the partitioning of the heat flux between radiation and convection, conduction down the thermocouple lead, thermal properties, time constant, deposition, condensation, catalysis, and so on.

The majority of the temperature measurement problems in fire testing stem from a misunderstanding of the fact that the thermocouple output is generally indicative of the thermocouple temperature and not the temperature of interest, whether it is a fire or a solid surface.

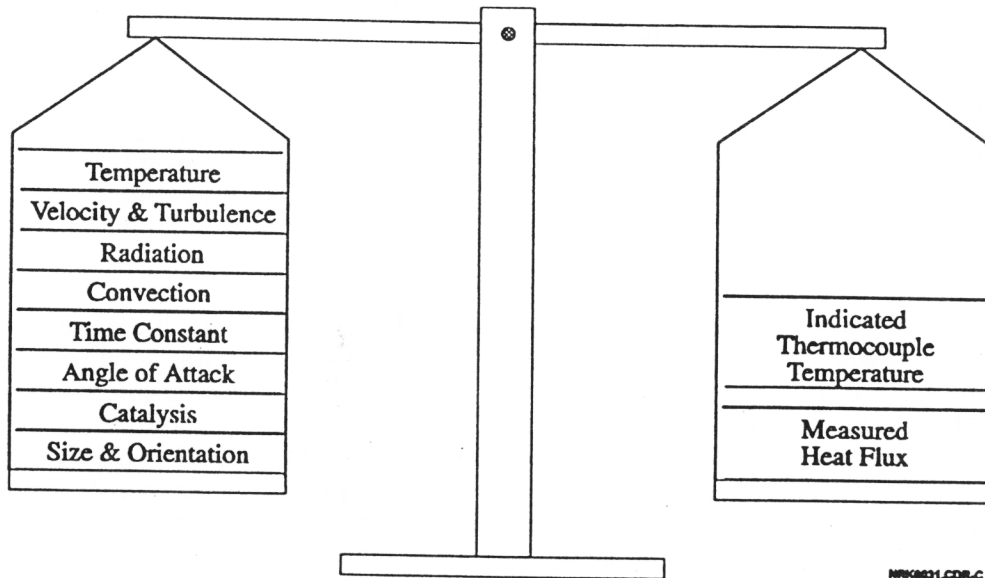


Figure 1 Simplified Models of Thermal Transducers

There are the two types of thermocouple applications that most often occur in fire response tests: a) measuring the "fire temperature" to help define or control the test environment and b) measuring the surface temperature to help define the response of the test item. A number of papers have been published that use resistance networks to evaluate steady state errors in furnace temperature measurements. Figure 2 shows the estimated errors for a purely radiative situation [Keltner and Moya, 1989]. In a two dimensional furnace with a participating media between the furnace wall and the test item, the analysis shows the strong effect of test item temperature and furnace gas emissivity on thermocouple measurement errors. When the test specimen temperature is one half the furnace wall temperature, the measurement error is more than 25 % if the gas emissivity is 0.1. The error drops to 19 % if the gas emissivity increases to 0.4

If the test item has a high thermal inertia, such as a concrete wall, it will heat slowly. As a result, the ratio of the test item temperature and the furnace wall temperature ( $T_t / T_w$ ) will rise slowly. This lower ratio implies larger "furnace temperature" measurement errors. The measurement errors are also affected by the type of fuel. For a clean burning fuel, such as methane, the gas emissivity depends on the  $H_2O$  and  $CO_2$  levels. An emissivity of 0.1 might be appropriate. For an oil fired furnace, the gas emissivity is expected to be higher due to the presence of soot. The higher gas emissivity implies lower "furnace temperature" measurement errors.

Manufacturers data on thermocouples often includes a time constant based on immersing the thermocouple in a flowing fluid at a different temperature. The time constant is measured by treating the thermocouple as a slug calorimeter. The analysis relates the heat stored in the thermocouple to the convective heat transfer between the thermocouple and the fluid.

$$\rho * c_p * V * (\Delta T / \Delta t) = h * A * (T - T_t).$$

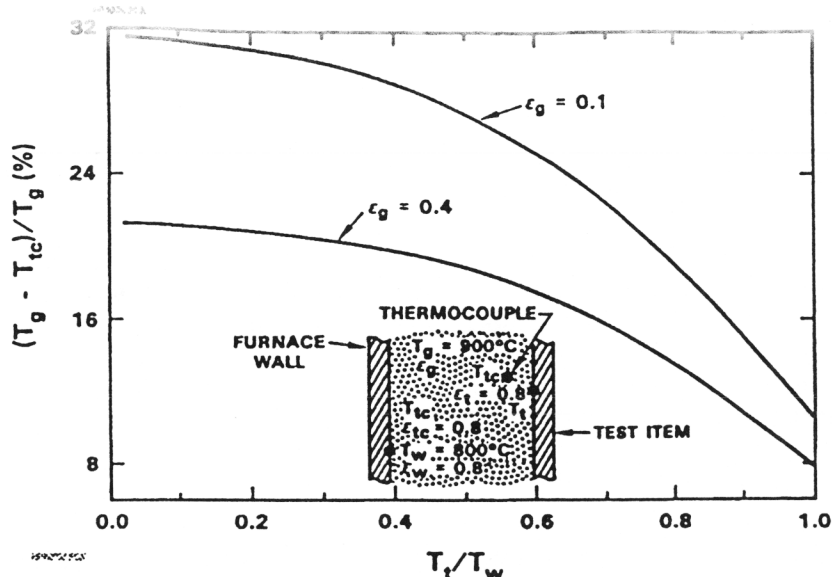


Figure 2 Gas Temperature Measurement Errors Due To Radiative Heat Transfer

The solution of this difference equation is

$$(T - T_r)/(T_o - T_r) = \exp(- (h \cdot A / \rho \cdot c_p \cdot V) \cdot t) = \exp(- Bi \cdot Fo)$$

where the quantity  $(\rho \cdot c_p \cdot V / h \cdot A)$  is the time constant of the thermocouple, Bi is the Biot modulus  $(h \cdot r / k_s)$ , and Fo is the Fourier number  $(\alpha \cdot t / r^2)$ . All of the parameters in the equation are related to the thermocouple, except for h - the heat transfer coefficient.

A typical correlation for the average convective heat transfer coefficient for a cylinder in crossflow is based on three dimensionless parameters; the Nusselt number -  $Nu = h \cdot d / k_f$ , the Reynolds number -  $Re = (V \cdot d) / (\mu / \rho)$  where  $\mu$  is the viscosity of the fluid (the quantity  $\mu / \rho$  is called the kinematic viscosity with a symbol  $\nu$ ), and the Prandtl number -  $Pr = c_p \cdot \mu / k$  or  $\nu / \alpha$ . For air the correlation is

$$Nu = C \cdot (Re)^n$$

where C and n depend on the Reynolds number [ Kreith, 1963]. The coefficients used for a gas flowing normal to a cylinder are shown in Table 1.

Table 1 Calculating Average Convective Heat Transfer Coefficients - Cylinder in Crossflow

Reynolds Number - $Re_D$	C	n
0.4 - 4	0.891	0.330
4 - 40	0.821	0.385
40 - 4000	0.615	0.466

In fire testing, the heat transfer coefficient for a thermocouple also has a radiation component. If the temperature of the thermocouple is reasonably close to the environment temperature, then equation for a linearized, radiation heat transfer coefficient has the form

$$q_r = h_r \cdot \Delta T = \{ \sigma \cdot \alpha \cdot e \cdot (T_1^3 + T_1^2 T_2 + T_1 T_2^2 + T_2^3) \} \cdot (T_1 - T_2)$$

where e is the effective emissivity of the gas stream,  $\alpha$  is the absorptivity of the thermocouple, and  $T_1$

is the temperature of the thermocouple and  $T_2$  is the effective radiation temperature of the gas stream. Another equation of this type is required to account for radiative heat transfer between the thermocouple and the walls of a furnace or a duct.

The Ohio State University Rate of Heat Release device (ASTM E-906 or the corresponding FAA - Heat Release Rate Test for Cabin Materials FAR 25.853) uses a thermopile to determine the rate of heat release from the sample. The thermopile response is determined by metering methane through a calibration burner at a rate such that the heat release rate is between 7.5 and 15 kW. If the thermocouple elements in the thermopile are treated as lumped systems, the response will be that of a first-order, low-pass system (i.e.,  $1 - \exp(-kt)$ ). As described above,

$$(T - T_f)/(T_o - T_f) = \exp(-h^*A/\rho^*c_p^*V)*t$$

where the quantity  $(\rho^*c_p^*V / h^*A)$  is the time constant of the thermocouple. All of the parameters in the equation are related to the thermocouple, except for  $h$  - the heat transfer coefficient. The heat transfer coefficient is the sum of the convective coefficient and the linearized, radiation coefficient.

In the OSU device, the air flow rate is set at  $0.04 \text{ m}^3 / \text{s}$ . The exhaust stack cross-section is  $133 \text{ mm} \times 70 \text{ mm}$ . The no-heat release velocity is  $4.3 \text{ m} / \text{s}$ . If all of the calibration heat release went into the air flow, the temperature rise would be over  $300 \text{ K}$ . To account for losses to the walls of the test unit, assume that one-half of the heat release goes to heat the air flow and one half to heat the chamber and duct walls.

For the  $0.51 \text{ mm}$  diameter thermocouple used in the thermopile with the air temperature at  $450 \text{ K}$  and the velocity of  $4.3*(450/300) \text{ m/s}$ ,

$$Re \sim 104 \quad \text{if } 40 < Re < 4000 \text{ then } C = 0.615 \text{ and } n = 0.466 \text{ [Kreith, 1963]}$$

$$Nu \sim 5.35$$

$$h \sim 400 \text{ W} / \text{m}^2\text{-K}$$

For the chromel - alumel thermocouple (Type K), the convective time constant is approximately 5 seconds.

Methane is a clean burning fuel. At the maximum methane flow rate used during calibration, the effective gas emissivity is approximately 0.1; this is calculated from the dimensions of the apparatus and the partial pressures of water vapor and carbon dioxide. Calculating the heat transfer rate indicates the linearized radiation heat transfer coefficient for the gas with a temperature difference of  $50 \text{ K}$  is much less than  $1 \text{ W} / \text{m}^2\text{-K}$ . As a result, gas radiation should not affect the time constant. The coefficient of radiation heat transfer with the stack is approximately  $20 \text{ W} / \text{m}^2\text{-K}$  or 5 % of the convective coefficient. It will increase or decrease the time constant depending on whether the wall temperature is higher or lower than the thermopile element temperature. If a sample produces more smoke than the calibration burner, the stack gas emissivity will increase. Everything else being equal, the time constant of the thermopile will change as the emissivity of the stack gas changes the radiative coupling of the thermocouple and the duct. This will affect the measurement of heat release rate.

A similar type of analysis could be done for the thermocouple used to correct the flow rate measurements in the duct of a cone calorimeter. With a velocity of  $1.2\text{-}3.5 \text{ m/s}$ ,  $Re \sim 100$  and  $Nu \sim 5$ . The time constant is estimated to be  $\sim 50\text{-}100 \text{ s}$ .

A common fire safety test for building materials is the ASTM method E-119. In this test, a furnace is controlled by a thermocouple mounted in a  $1/2"$  ( $13 \text{ mm}$ ) thermowell. The time constant is defined to be in the range of 5.0 to 7.2 minutes. Babrauskas and Williamson, 1979, compared the response of the ASTM thermocouple, a  $6.4 \text{ mm}$  OD metal sheathed thermocouple, and a  $0.81 \text{ mm}$  bare wire thermocouple in an E-119 furnace. During the first five minutes of the test, the difference between the ASTM control thermocouple and the bare wire was as much as  $550 \text{ C}$ .



Standardized fire safety testing, including some fire calorimetry, tries to overcome measurement errors by specifying the thermocouple design, such as the E-119 thermocouple. While this doesn't eliminate the error, it does help standardize it as long as you don't change testing labs and the conditions in the lab don't change.

Heat flux is another critical measurement in fire response tests. A common perception is that a fire environment can be specified by specifying the "fire temperature." Figure 3 shows data obtained from a number of large pool fire tests conducted at Sandia National Laboratories. The relationship between temperature and heat flux is anything but clear. It appears that if the heat flux is assumed to be the blackbody radiative flux corresponding to the measured "fire temperature", the estimated heat flux will be within a factor of two of the measured heat flux.

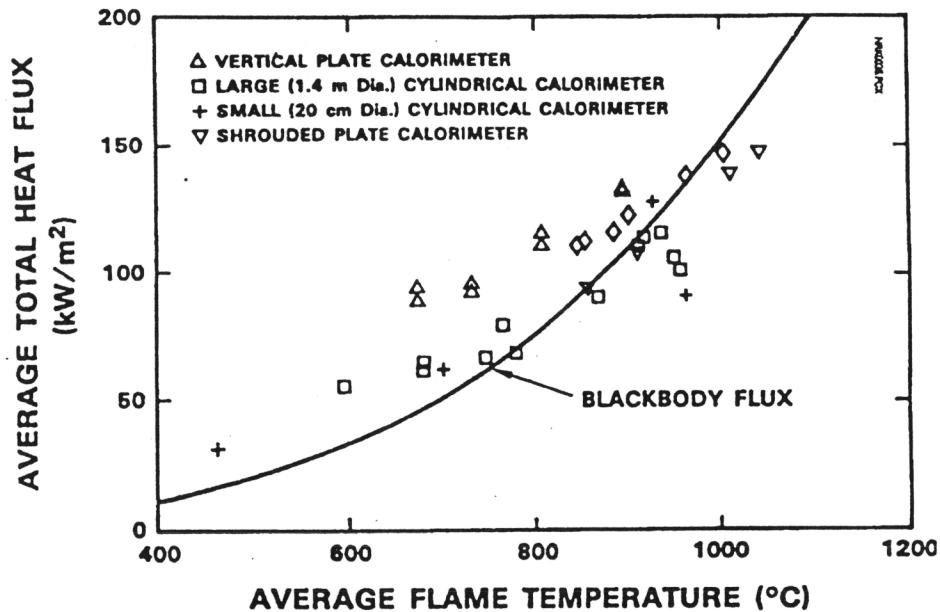


Figure 3 Cold Wall Heat Flux as a Function of Average Measured Flame Temperature

There are three basic heat flux measurement methods in use. Slug calorimeters rely on a change in temperature; these are the simplest but are a transient measurement. The most widely used slug calorimeter in fire safety tests is the E-119 furnace thermocouple which has a time constant of 5-7 minutes; however, calorimetric analysis is not generally applied to the data from it. All of the heat flux data shown in Figure 3 was acquired with slug type calorimeters; the largest of these was 1.5 m OD x 6 m long and weighed 10 tons. Inverse heat conduction codes were used to estimate the heat fluxes from measurements of calorimeter temperature. The most common heat flux sensors in fire safety tests are the Gardon gages, which were designed for aerospace applications and use a differential thermocouple design, and the Schmidt-Boelter gages, which use a thermopile design. Both sensors are generally water cooled and are quasi-steady measurements. They are used as both radiometers and as total heat flux (i.e., radiation + convection) sensors. All three heat flux sensors can be affected by the same phenomena as the thermocouples; however, as a result of the different designs each one reacts differently to the different phenomena.

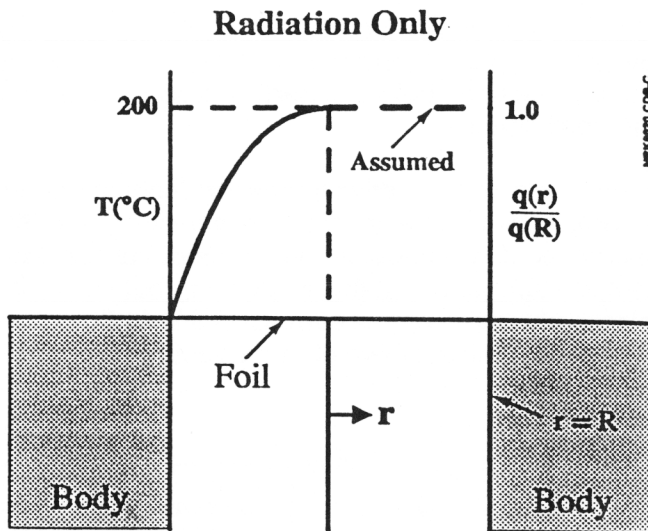
The Gardon gage can be used to illustrate the potential for problems. Figure 4 shows the standard model for the operation of a Gardon gage. The temperature distribution across the constantan disk has a parabolic distribution. The differential between the center and the edge of the disk is approximately 200 K; this provides a nominal output of 10 mV from the copper-constantan differential thermocouple. The assumption is made that the heat flux is uniform over the sensing element.

Figure 5 shows more representative temperature and heat flux distributions across the sensing element for radiative heating or stagnation flow convective heating [Sobolik, et al, 1989]. The source temperature for both cases is 1000 C. It shows the gage has different sensitivities to radiative and convective heat transfer. The different sensitivities result from non-uniform heat transfer. As a result of the 200 K operating differential at full scale output, the convective heat flux varies across the sensing element by 20 %. The result is a Gardon gage has one sensitivity for radiative heating and a different one for convective heating. The gage is normally calibrated using a radiant source. Borell and Diller, 1987, developed a convective calibration method. These different calibrations can be used with a steady-state model developed by Kuo and Kulkarni, 1991, to estimate uncertainties. While Gardon gages can be individually calibrated for different types of heating, there is no method for separating mixed signals. The best approach for reducing these errors is to use a gage with an operating range that is 100 times larger than the expected heat flux level and a high quality DC amplifier. This approach reduces the  $\Delta T$  across the gage from 200 K to 2 K. The smaller temperature difference reduces the radial variation in the heat flux and thus the differences between radiation and convection.

A common approach in fire safety testing is to attempt to separately measure the radiative heat flux using a Gardon gage with a sapphire window. The sapphire has a transmissivity of approximately 85 % out to a wavelength of approximately 5  $\mu$ . The window used in a radiometer can absorb a significant fraction of the radiant energy. For sapphire, this ranges from 76 % for a 300 C source to 55 % at 500C to 23 % at 1000 C. The absorptive coating of the sensor is not spectrally flat. As a result, if the gage is calibrated with a source that has a different spectral distribution, due to temperature or emissivity effects) than the experiment, there will be a measurement error. To properly account for these two effects, it is necessary to relate the configuration factor and temperature of the radiant calibration system with those in the experiment. This will be extremely difficult.

Operation of either the Gardon or Schmidt-Boelter gages with the cooling water temperature below the local dew point will produce condensation errors. For the Gardon gage, a first estimate of the size of the annular region affected by condensation can be obtained from Figure 4. The temperature profile is parabolic; it varies as  $1 - (r/R)^2$ . The peak temperature is the ratio of the heat flux to the gage range multiplied by 200. Calculate the value of r such that

$$T(r) = \Delta T(\max) * \{1 - (r/R)^2\} + T(\text{cooling water}) = T(\text{dew point})$$



Center Wire  
Figure 4 Ideal Analysis of a Gardon Gage

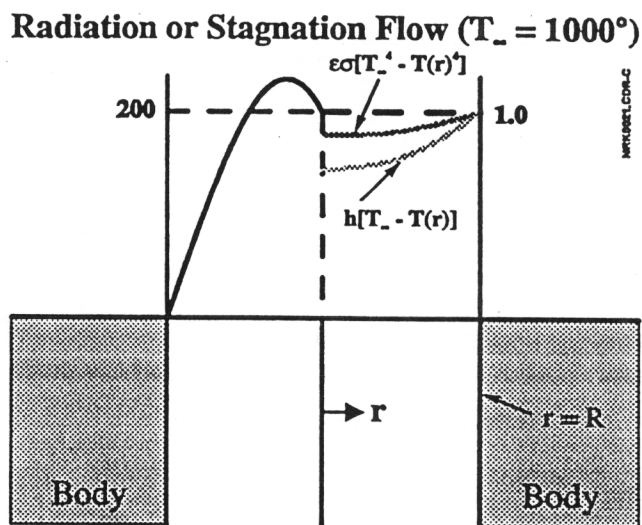


Figure 5 Realistic Analysis of a Gardon Gage

It is obvious that to eliminate the potential for condensation errors, the cooling water temperature should be higher than the dew point.

Figure 6 shows the temperature distribution when a Gardon gage is used in a shear flow, such as the flow up a wall in a room burn test. Asymmetric heating of the sensor by the shear flow will render it essentially unusable.

The potential effect of all of these problems is to take a sensor that has a specified accuracy of +/- 3% (ASTM Standard E511) and provide a measurement that has an overall uncertainty as large as +25% and -50% in actual use. This is obviously not desirable.

The Schmidt-Boelter gage has some of the same problems and some different ones. A number of these are covered in Kidd and Nelson, 1995. A common problem with all water cooled gages in shear flow environments is boundary layer tripping due to temperature differences between the wall and the gage. This can significantly increase the convective heat transfer to the gage.

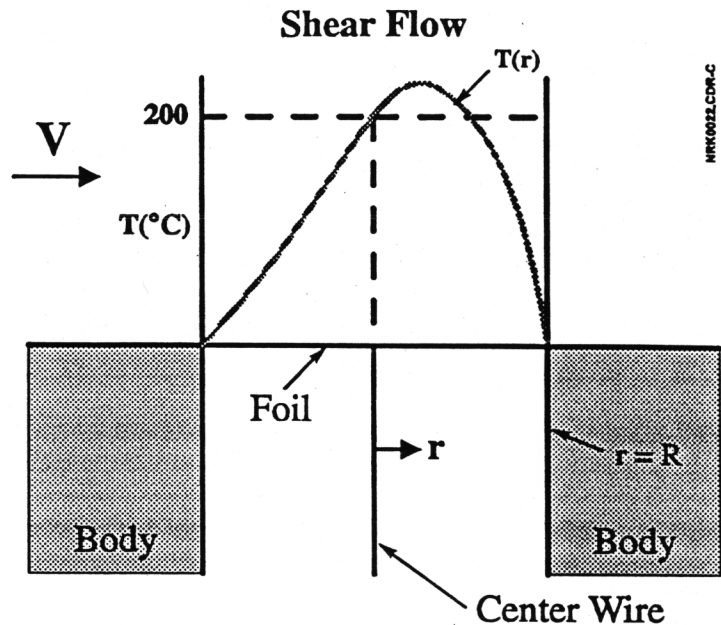


Figure 6 Model for a Gardon Gage in Shear Flow

Because fire calorimetry and fire safety testing in general are dynamic processes, dynamic measurement errors can also produce serious problems. Problems arise when analyzing data from multiple sensors, such as thermocouples and heat flux gages, which have different time constants. Metal sheathed thermocouples, with a diameter of a few millimeters, are commonly used in fire safety tests; their time constant will be on the order of a few seconds. The Gardon gages typically have a nominal time constant of several hundred milliseconds. The 3 db down or half power frequency for a first order, low pass system is defined by

$$f_{1/2} = 1 / 2 * \pi * \tau$$

where  $\tau$  is the time constant in seconds [Bickle and Keltner, 1978]. A Gardon gage with a nominal time constant of 160 ms would have a 3 db frequency of 1 Hz. For a thermocouple with a time constant of 3.2 s, the frequency would be 0.05 Hz. If there is a characteristic frequency associated with the experiment, such as the puffing frequency of a pool fire, estimates can be made of the amplitude attenuation and phase lag introduced into the measurements by these thermal inertia effects. If not properly accounted for, such differences in frequency response of the sensors will appear as noise in many numerical analyses, such as parameter estimation or cross correlation.

Unfortunately, the time constant for a thermocouple in a fire is not constant. This leads to further difficulties. Some of these are discussed in Weckman and Sobiesiak, 1988, and Gritz, et al, 1995.

As noted above, measurements are often considered to be the standard against which we should compare and validate our analyses. Unfortunately, it is easy to lie with (or be lied to by) our measurements, especially in fires. The basic effect is called **MEASUREMENT MAGIC**. In this type of illusion, the sensor appears to be giving a correct reading or at least one that agrees with your intuition. Measurement magic is a real effect. It is not an artificial effect, such as lying with statistics, and it is not as obvious. (Before the modelers point their fingers and say I told you so, remember there is a corresponding form of illusion called **MODEL MAGIC**. However, that's another story.)

## References

Babrauskas, V. and Williamson, R. B., "Temperature measurements in Fire Test Furnaces," *Fire Technology*, Vol. 14, pp. 226-238, 1978.

Bickle, L. W. and Keltner, N. R., "Estimation of Transient Measurement Errors," Sandia National Laboratories, Albuquerque, NM, Report SAND78-0497, August, 1978.

Borell, G. J. and Diller, T. E., "A Convection Calibration Method for Local Heat Flux Gages," *Journal of Heat Transfer*, Vol. 109, 1987, pp. 83-89.

Gritzo, L. A., Gill, W., and Keltner, N. R., "Thermal Measurements to Characterize Large Fires," Instrument Society of America, Proceedings of the 41st International Instrumentation Symposium, Aurora, Colorado, May, 1995.

Keltner, N. R. and Moya, J. L., "Defining the Thermal Environment in Fire Tests," *Fire and Materials*, Vol. 14, pp.133-138, 1989.

Kidd, C. T. and Nelson, C. G., "How the Schmidt-Boelter Gage Really Works," Proceedings of the 41st International Instrumentation Symposium, Instrument Society of America, ISSN 0227-7576, Aurora, Colorado, May, 1995.

Kuo, C. H. and Kulkarni, A. K., "Analysis of Heat Flux Measurement by Circular Foil Gages in a Mixed Convection / Radiation Environment," ASME / JSME Thermal Engineering Proceedings, ASME, Vol. 5, 1991.

Sobolik, K. B., Keltner, N. R., and Beck, J. V., "Measurement Errors for Thermocouples Attached to Thin Plates: Application to Heat Flux Measurement Errors," *Heat Transfer measurements, Analysis, and Flow Visualization*, Edited by R. K. Shah, ASME-HTD Vol.112, 1989.

Weckman, E. J. and Sobiesiak, A., "The Effects of Digital Compensation on Temperature Measurements in an Intermittent Combusting Flow," ASME-HTD-Vol. 104-Part 2, pp. 65-72, Nov., 1988.

FLAMMABILITY OF SMALL SPECIMENS USING A  
THERMOANALYTICAL TECHNIQUE

Thomas D. Gracik and George L. Long  
Carderock Division, Naval Surface Warfare Center  
Fire Protection and Survival Branch  
Code 643  
1661 Bay Head Road  
Annapolis, MD 21401-5712  
USA

An off-the-shelf thermogravimetric (TG) instrument was modified by coupling CO and CO<sub>2</sub> instrumentation to the TG furnace. Combustion conditions within the TG furnace were modified by manipulation of the air flow into the TG furnace. The CO and CO<sub>2</sub> data were used to calculate heat release rates of polyethylene. Manipulation of the air flow in effect optimizes the measurement of a broad range of ventilation conditions.

A NOVEL THERMOGRAVIMETRIC TECHNIQUE FOR DETERMINING FLAMMABILITY  
CHARACTERISTICS OF POLYMERIC MATERIALS

Thomas D. Gracik,<sup>1</sup> George L. Long,<sup>1</sup> Usman A.K. Sorathia,<sup>2</sup> and  
Henry E. Douglas<sup>3</sup>

<sup>1</sup>Survivability and Fire Research Laboratory,  
David Taylor Research Center, Post Office Box 418, Arnold MD 21012

<sup>2</sup>Composites and Resins Branch, Code 2844  
David Taylor Research Center,  
Annapolis, MD 21402

<sup>3</sup>Department of Mechanical Engineering, FU-10, University of  
Washington, Seattle WA 98195

ABSTRACT

This paper reports a new thermogravimetric (TG) technique. Gases evolved during TG runs are analyzed for flammability characteristics including chemical heat release rate. Computations for two composites, glass/polyphenylene sulfide (PPS) and graphite/phenolic, are presented and compared to literature data.

INTRODUCTION

The reported work is part of an effort to demonstrate that thermo-analytical techniques can predict flammability properties of polymeric materials. Earlier experiments examined the relationships between TG char and Limiting Oxygen Index at elevated temperatures.<sup>1</sup> This paper applies a method developed by Dr. Archibald Tewarson, Factory Mutual Research Corporation (FMRC), Norwood, Massachusetts, for the FMRC heat release apparatus, to the burning behavior of materials in a TG furnace.<sup>2,3</sup> It utilizes the principle that heat generated by a burning specimen leads to the generation of CO and CO<sub>2</sub> which may be used to calculate its chemical heat release rate.

Other techniques for measurement of chemical heat release rate include the "Ohio State" heat release rate apparatus,<sup>4</sup> and the "National Institute of Standards and Technology" cone calorimeter.<sup>5</sup> Under conditions of these techniques, a specimen is exposed to a constant heat flux and such data as the evolved gases produced by the burning specimen and mass loss are analyzed. The underlying principle common to these chemical heat release measurement techniques involve exposing a specimen in a furnace to a calibrated heat flux. This principle can be applied to the thermogravimetric analyzer.

In addition to being able to operate under constant heat flux or isothermal conditions, as the above chemical heat release rate instruments, the TG furnace has the capacity to operate under a

temperature gradient as well as a variety of purge gas conditions. Since TG instruments are commonly found in laboratories, the cost associated with setup of chemical heat release rate experiments can be minimized. Another advantage of TG instrumentation is that it uses small samples. Large samples are not always available for analysis.

Quantitative data is provided to support the hypothesis that TG techniques utilizing small samples may be an alternate approach to determining chemical heat release rates. The primary purpose of this paper, however, is to provide the methodology required to perform the flammability calculations.

## EXPERIMENTAL

### INSTRUMENTATION

Figure 1 is a schematic of the experimental setup necessary for the DuPont 951 TG analyzer to function as a chemical heat release rate apparatus. The air flow entering the TG furnace was controlled by a Matheson Model 8102-1433 mass flow controller. The specimens were heated at a rate of 20°C/minute in the air atmosphere flowing at 500 ml per minute. The air purge gas along with gases that evolve from the heated specimen were transported between components of the experimental setup via flexible plastic and copper tubing. A glass wool filter and cold bath at 0°C were positioned upstream from the Beckman 865 CO and 864 CO<sub>2</sub> infrared analyzers. This prevented soot and water from entering the gas analyzers. A soap bubble rotameter was used to monitor the exit flow to ensure that it was the same as the incoming flow.

### SPECIMENS

A glass/polyphenylene sulfide composite, AG 40-70, supplied by Phillips Petroleum Company was one of two specimens used in this experiment. The second specimen, a graphite/phenolic composite, was fabricated at David Taylor Research Center. The sample was made from a woven fabric prepreg which was autoclaved at 177°C for two hours. After the autoclave treatment, the graphite/phenolic composite was postcured at a series of elevated temperatures in a convection oven. The thickness of the cured panel was 4.4 mm and had a 55-60% fiber volume fraction. Specimens were cut from the bulk composites into sizes approximately 3 mm by 5 mm by 2 mm and weighed approximately 50 mg.

### PROCEDURE

The controller was set to flow at 500 ml/minute and the CO and CO<sub>2</sub> analyzers were calibrated with span gases. Before each run, a control run was made with an empty sample holder. The control run was checked for evolution of CO and CO<sub>2</sub>. After the furnace had cooled, a specimen was placed in the TG platinum specimen holder and heated at a rate of 20°C per minute. Measurement of weight loss,

CO, and CO<sub>2</sub> began immediately. Heating and data collection were terminated at 1100°C.

## RESULTS

In order to prove the effectiveness of the TG technique for measurement of combustion efficiency, the portion of the TG curves shown in Figures 2a and 2b associated with weight loss of resin was analyzed separately from the fiber component. This allowed for the TG data for the resin component to be compared to literature data. It was assumed that the glass fibers of the glass/PPS run shown in Figure 2a did not lose weight. For the graphite/phenolic run shown in Figure 2b, mass loss and generation of CO<sub>2</sub> originating from phenolic resin was assumed to occur between 100% and 60%.

Combustion efficiency has been calculated from values for maximum possible yield of CO<sub>2</sub>, average generation of material vapors, and average generation of CO<sub>2</sub>. As a qualitative comparison, the combustion efficiency calculations are compared to the value of polystyrene calculated using the Factory Mutual Rate of Heat Release Apparatus. Since polystyrene is less thermally stable than PPS and phenolic resins, one would expect polystyrene to be better at supporting combustion.

Values for chemical heat release rate have been calculated from the average generation of CO<sub>2</sub> which has been estimated from data for density of air, purge gas flow rate, and average concentration of CO<sub>2</sub>. Calculations for average concentration of CO<sub>2</sub> generated utilized the mean for all combustible components.

### MAXIMUM POSSIBLE YIELD OF CO<sub>2</sub>

Assuming combustion will proceed to completion, oxidation of glass/PPS composite in air may be written as:



Because the glass fibers did not undergo oxidation, the maximum possible yield of CO<sub>2</sub>,  $k_{\text{CO}_2}$ , may be determined from the above stoichiometric equation, which assumes conservation of mass<sup>3,6</sup>:

$$k_{\text{CO}_2} = \frac{\text{weight of CO}_2 \text{ generated}}{\text{weight of PPS repeat unit}} = 2.44 .$$

In the case of graphite/phenolic composite, both phenolic resin and graphite fibers may react with oxygen to produce CO<sub>2</sub>;

$k_{\text{CO}_2} = 2.90$  for polyphenolic resin  $(-\text{C}_7\text{H}_6\text{O}-)_n$  and

$k_{\text{CO}_2} = 3.66$  for graphite (C).



#### GENERATION OF MATERIAL VAPORS

The rate at which material vapors are generated,  $\dot{m}$ , is derived from the slope of the TG mass loss curve and the associated heating rate; for the glass/PPS composite run provided in Figure 2a:

$$\dot{m} = \frac{(0.0482 - 0.0358)g}{(701 - 504)^{\circ}\text{C}} \left( \frac{0.333^{\circ}\text{C}}{\text{sec}} \right) = 2.10 \times 10^{-5} \frac{g}{\text{sec}}$$

Upon heating at 20 °C per minute in the range 504-701°C, glass/PPS composite decomposes at a average rate of  $2.10 \times 10^{-5}$  grams/sec, producing vapors, heat, and fire products.

For both components in the graphite/phenolic composite TG run shown in Figure 2b, the average generation of material vapors is:

$$\dot{m} = \frac{(0.0472 - 0.000330)g}{(925 - 374)^{\circ}\text{C}} \left( \frac{0.333^{\circ}\text{C}}{\text{sec}} \right) = 2.83 \times 10^{-5} \frac{g}{\text{sec}}$$

The generation of material vapors associated with the first weight loss transition representing phenolic resin is:

$$\dot{m} = \frac{(0.0472 - 0.0294)g}{(579 - 374)^{\circ}\text{C}} \left( \frac{0.333^{\circ}\text{C}}{\text{sec}} \right) = 2.88 \times 10^{-5} \frac{g}{\text{sec}}$$

#### GENERATION OF CO<sub>2</sub>

The gases evolved during the TG runs were measured downstream from the TG furnace after flowing through a cold trap at 0 °C. At 0 °C, the density of CO<sub>2</sub> is 0.00197 grams per milliliter. Therefore, the calculation for average generation of CO<sub>2</sub>,  $\dot{G}_{\text{CO}_2}$ , for glass/PPS composite at an air flow rate of 8.33 mL/sec is:

$$\dot{G}_{\text{CO}_2} = \left( \frac{0.00197g}{\text{mL}} \right) \left( \frac{8.33\text{mL}}{\text{sec}} \right) \left( \frac{\% \text{CO}_2}{100} \right) :$$

$$\dot{G}_{\text{CO}_2} = \left( \frac{0.000164g}{\text{sec}} \right) \% \text{CO}_2 .$$

The average concentration of CO<sub>2</sub> calculated from the glass/PPS composite data shown in Figure 2a is 0.155% CO<sub>2</sub>. Therefore, the average mass of CO<sub>2</sub> generated is:

$$\dot{G}_{\text{CO}_2} = 2.54 \times 10^{-5} \frac{g_{\text{CO}_2}}{\text{sec}}$$

For both components of graphite/phenolic composite,

$$\dot{G}_{CO_2} = 8.05 \times 10^{-3} \frac{g_{CO_2}}{sec}$$

The average generation of CO<sub>2</sub> for the resin portion of the graphite/phenolic composite is:

$$\dot{G}_{CO_2} = 4.35 \times 10^{-3} \frac{g_{CO_2}}{sec}$$

#### COMBUSTION EFFICIENCY

The actual yield of CO<sub>2</sub>, Y<sub>CO<sub>2</sub></sub>, produced during the TG run may be calculated from the following relationship<sup>3, 6</sup>:

$$Y_{CO_2} = \frac{\dot{G}_{CO_2}}{\dot{m}}$$

Combustion efficiency, f<sub>CO<sub>2</sub></sub>, then may be calculated<sup>3, 6</sup>:

$$f_{CO_2} = \frac{Y_{CO_2}}{k_{CO_2}}$$

The yield of CO<sub>2</sub> and combustion efficiency for the glass/PES composite are:

$$Y_{CO_2} = \frac{2.54 \times 10^{-3} g/sec}{2.10 \times 10^{-3} g/sec} = 1.21 ;$$

$$f_{CO_2} = \frac{1.21}{2.44} = 0.50 .$$

The yield of CO<sub>2</sub> and combustion efficiency for the phenolic composite based upon resin and graphite contributions are:

$$Y_{CO_2} = 2.84 ;$$

$$f_{CO_2} = 0.43 .$$

The above yield is approximately equal to the maximum for phenolic resin, 2.90. The high value indicates that both components of the composite, have undergone oxidation. Analysis of just the first weight loss transition representing phenolic resin shows:

$$Y_{CO_2} = 1.51 ;$$

$$f_{CO_2} = 0.52 .$$

#### CHEMICAL HEAT RELEASE RATE

The generation of CO and CO<sub>2</sub> may be used to calculate the chemical heat release rate,  $\dot{Q}_c$ , by the following relationship<sup>3,6</sup>:

$$\dot{Q}_c = \frac{\Delta H_T}{k_{CO_2}} \dot{G}_{CO_2} + \frac{\Delta H_T - \Delta H_{CO}}{k_{CO}} \dot{G}_{CO} .$$

$\Delta H_T$  is the net heat of complete combustion.

$\Delta H_{CO}$  is the heat of combustion of CO.

$k_{CO}$  is the maximum possible theoretical yield of CO.

Since the generation of carbon monoxide in the TG experiments was small (0.010% and 0.047% for glass/PPS and graphite/phenolic, respectively), the second half of the equation is close to zero; due to its insignificant value, it was omitted for estimating purposes.

The mean empirical value<sup>7</sup> of  $\frac{\Delta H_T}{k_{CO_2}}$  is roughly equal to

12.3kJ/gram. Under these conditions,  $\dot{Q}_c$  for the glass/PPS composites is:

$$\dot{Q}_c = (12.3\text{kJ/gram})(2.54 \times 10^{-5} \text{ grams/sec}) = 3.12 \times 10^{-4} \text{ kJ/sec} .$$

The surface area of the top side of the TG specimens is roughly  $1.54 \times 10^{-5} \text{ m}^2$ . Therefore, the chemical heat release rate per unit area for the glass/PPS composite under conditions of the TG furnace is approximately:

$$\dot{Q}_c'' = \frac{3.12 \times 10^{-4} \text{ kJ/sec}}{1.54 \times 10^{-5} \text{ m}^2} = 20.3 \text{ kW/m}^2 .$$

Calculations for graphite/phenolic composite show:  $\dot{Q}_c'' = 64.3 \text{ kW/m}^2$ .

#### DISCUSSION

##### COMBUSTION EFFICIENCY

The calculated combustion efficiency for the PPS and phenolic composites, 0.50 and 0.52, respectively, are lower than the value associated with polystyrene, 0.69.<sup>6</sup> This is appropriate because the aromatic group is part of the backbone structure of PPS and phenolic resins, producing a thermally stable structure. On the other hand, polystyrene has its aromatic structure in the pendant position, which produces a more flammable material.<sup>6</sup>

#### CHEMICAL HEAT RELEASE RATE

In the TG run shown in Figure 2a, glass/PPS composite generated vapors between 504-701 °C. These temperatures correspond to an external heat flux of 20-51 kW/m<sup>2</sup> by the Stefan-Boltzmann fourth power law. Literature values for this glass/PPS composite indicate that it does not ignite when exposed to cone calorimeter radiant heat flux conditions of 25 kW/m<sup>2</sup>. However, the composite generated an average chemical heat release rate of 25 kW/m<sup>2</sup> when exposed to a 50 kW/m<sup>2</sup> radiant heat flux.<sup>9</sup> Calculations for average chemical heat release rate using the TG evolved gas data yielded a value of 20.6 kW/m<sup>2</sup>, which compares well with literature data. Although our TG experiments were conducted under a temperature gradient of 20 °C/min, the evolved gas analysis for chemical heat release rate are of the same order of magnitude as the isothermal conditions of cone calorimetry experiments.

Figure 2b shows that the graphite/phenolic composite loses mass between 373-925 °C. The associated external heat flux is 9 to 117 kW/m<sup>2</sup>. Cone calorimeter runs of the same material<sup>10</sup> indicate that it does not ignite when exposed to an external heat flux of 25 kW/m<sup>2</sup>. When the heat flux is increased to 75 kW/m<sup>2</sup>, the average cone calorimeter chemical heat release rate is 80 kW/m<sup>2</sup>. The average chemical heat release rate of 64.3 kW/m<sup>2</sup> calculated from TG evolved gas data is also in agreement with literature values.

#### CONCLUSIONS

This new TG technique demonstrates correlation with today's calorimetry methods for preliminary quantitative analysis of chemical heat release rate and other flammability characteristics of organic materials.

Advantages to the use of TG instrumentation for analysis of material flammability characteristics include: TG sample sizes are small therefore, associated sample preparation costs are low; TG instrumentation is widely available so costs are minimized; TG is versatile because experiments may be conducted under a broad range of furnace and purge gas conditions.

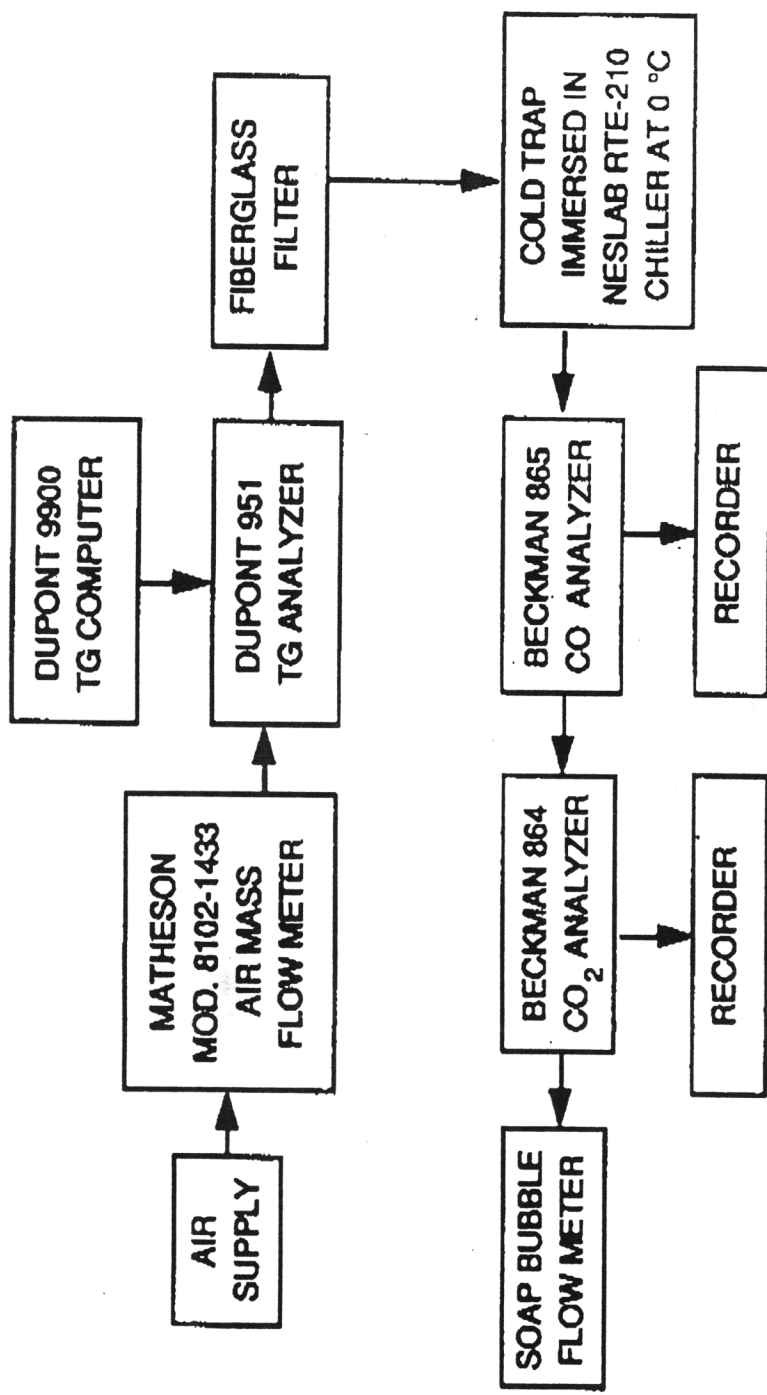
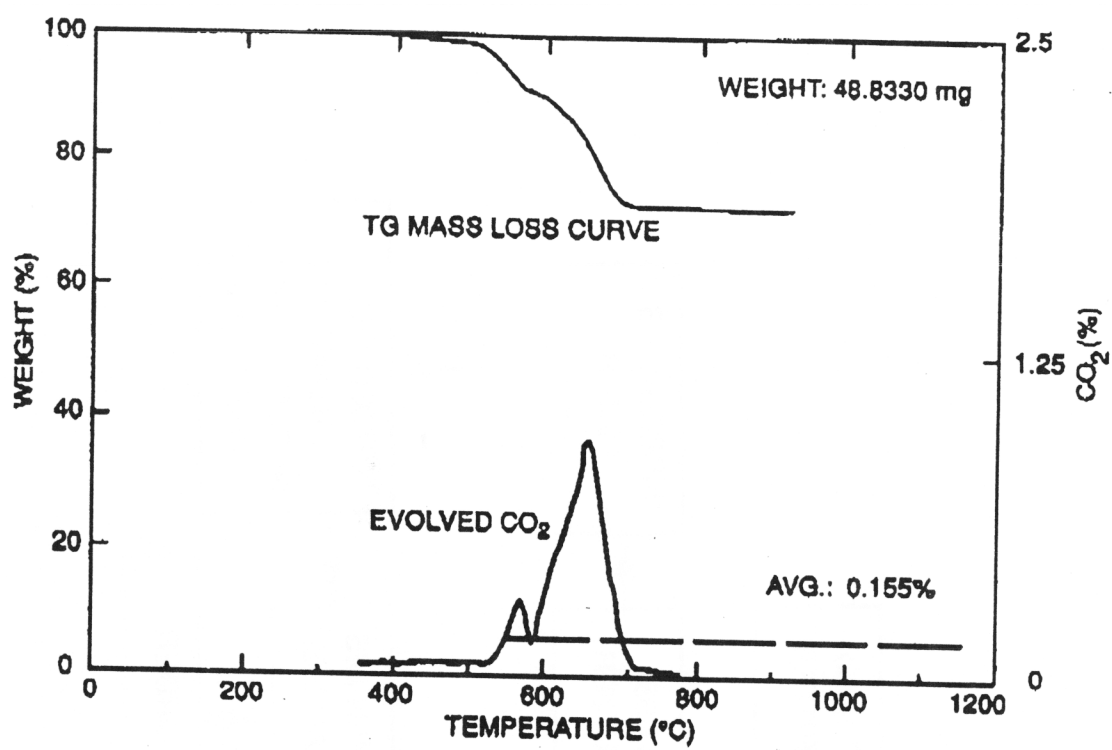
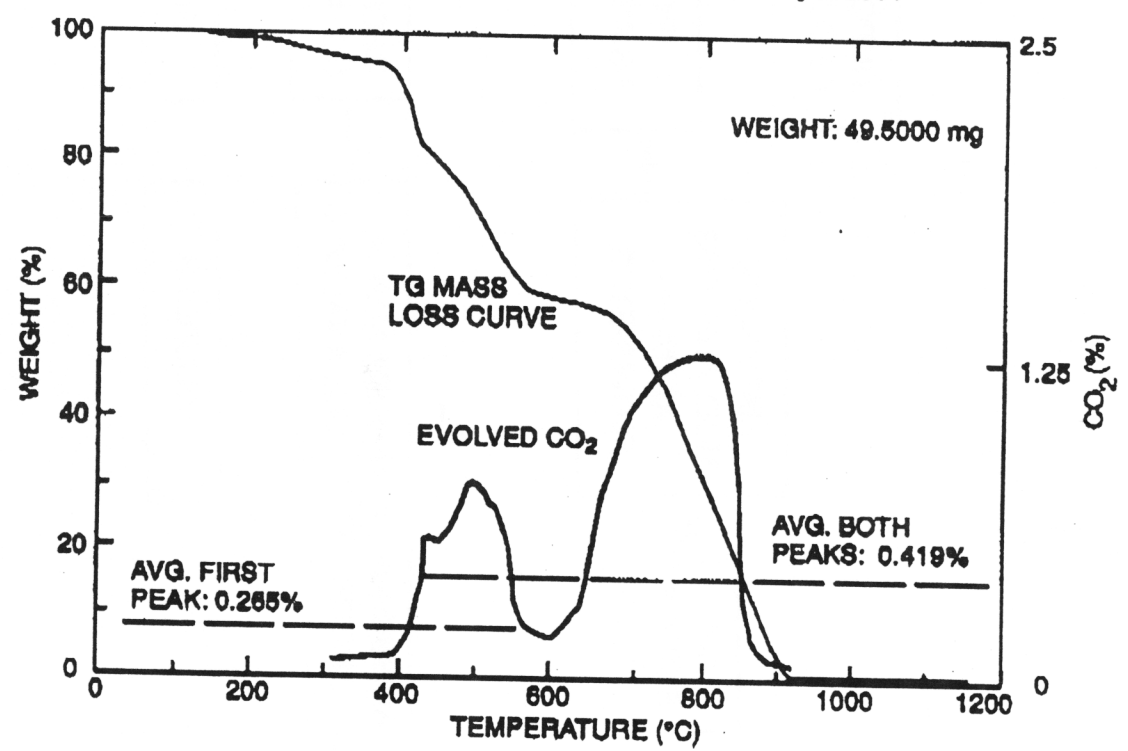


Figure 1. Flow diagram of TG evolved gas instrumentation.



a. Glass/polyphenylene sulfide composite.



b. Graphite/phenolic composite

Figure 2. TG runs of glass and graphite composites

#### REFERENCES

1. Gracik, T.D. and G.L. Long, "Prediction of Flammability of Thermoplastics by TGA," in: 18th Proceedings of the North American Thermal Analysis Society Conference, pp. 82-91, San Diego, Calif. (24-27 Sep 1989).
2. Tewarson, A. and R.F. Pion, "Flammability of Plastics-I. Burning Intensity," *Combustion and Flame*, 26, pp. 85-103 (1976).
3. Tewarson, A., "Flammability Characteristics of Fiber Reinforced Composite Materials," Technical Report MTL TR 90-41, US Army Materials Technology Laboratory, Watertown, Mass. (Aug 1990).
4. "Standard Test Method for Heat and Visible Smoke Release Rates for Materials and Products," ASTM E 906, The American Society for Testing and Materials, Philadelphia, PA.
5. "Standard Test Method for Heat and Visible Smoke Release Rates for Materials and Products Using an Oxygen Consumption Calorimeter," ASTM E 1354, The American Society for Testing and Materials, Philadelphia, PA.
6. Tewarson, A., "Generation of Heat and Chemical Compounds in Fires," in: *SFPE Handbook of Fire Protection Engineering*, National Fire Protection Association, pp. 1-179, National Fire Protection Association, Quincy, Mass. (1988).
7. Tewarson, G., "Experimental Evaluation of Flammability Parameters of Polymeric Materials," in: *Flame Retardant Polymeric Materials*, vol. 3, pp. 97-153, Plenum Press, New York (1982).
8. Pearce, E.M., Y.P. Khanna, and D. Raucher, "Thermal Analysis in Polymer Flammability," In: *Thermal Characterization of Polymeric Materials*, edited by Edith A. Turi, Academic Press, Inc., Orlando, FL (1981).
9. Sorathia, U., T. Dapp, and J. Kerr, "Flammability Characteristics of Composites for Shipboard and Submarine Internal Applications," in: 36th International SAMPE Symposium, pp. 1868-1878, San Diego, Calif. (15-18 Apr 1991).
10. Sorathia, U., C.M. Rollhauser, and W. Allen Hughes, "Improved Fire Safety of Composites for Naval Applications," in: 16th International Conference on Fire Safety, pp. 300-312, San Francisco, Calif. (14-18 Jan 1991).

## CHARACTERIZATION OF INCIDENT HEAT FLUXES AND OBJECT THERMAL RESPONSE IN LARGE HYDROCARBON POOL FIRES<sup>†</sup>

Louis A. Gritzo<sup>\*</sup>, Jaime L. Moya<sup>\*\*\*</sup>, Douglas Murray<sup>\*\*</sup>, and Edward Muzio<sup>\*</sup>

<sup>\*</sup>Thermal and Fluid Engineering, Department 1513, MS 0835

<sup>\*\*\*</sup>Thermal Characterization and Simulation, Department 2735, MS 1135  
Sandia National Laboratories, P. O. Box 5800  
Albuquerque, NM 87185

<sup>\*\*</sup>Ordnance Test and Evaluation, Code 529610D  
Naval Air Warfare Center, Weapons Division  
China Lake, CA 93555

Exposure to a large hydrocarbon fuel fire is one of the many scenarios to be addressed during the design and assessment of fire-survivable engineered systems. Such a fire could occur as a result of a transportation accident. A knowledge of the heat flux distribution to objects in these fires, and an understanding of the thermal response of objects subjected to such environments, is critical for assessing existing systems and for achieving improvements in system design.

The unique requirements associated with heat flux measurements in fire environments can often be satisfied by measuring transient and spatial temperature profiles of well-characterized calorimeters. Heat fluxes measured using such techniques can subsequently be replicated using the full scale, adaptable radiant heating facility at Sandia National Laboratories (SNL). This approach allows thorough investigation of the thermal response of systems which include melting or decomposing materials.

Design, analysis of temperature data, and resulting heat flux estimates for 1m diameter, 1.5 m long cylindrical calorimeters fully engulfed in a 18.9 m diameter JP-8 pool fire are presented here. The calorimeters were positioned on one side such that the axis is parallel to the fuel surface. Maximum heat fluxes of approximately 150 kW/m<sup>2</sup> are observed at varying locations on the calorimeters depending on the location and the orientation of the calorimeter in the fire. Heat flux measurements to the pool surface are also described and presented. Calorimeter heat flux trends agree favorably with trends observed in measured heat fluxes to the pool surface and nearby thermocouple temperature measurements.

---

<sup>†</sup> This work was sponsored by the Defense Nuclear Agency Weapons System Safety Assessment and Fuel Fire Techbase Programs and was performed in part at Sandia National Laboratories under United States Department of Energy contract DE AC04-94 AL85000.



## FIRE GAS CHARACTERIZATION VIA POTENTIAL OXYGEN CONSUMPTION CALORIMETRY

David S. Morrison  
Advanced Systems Technology  
2121 Crystal Drive, Suite 514  
Arlington, VA 22202

Richard C. Corlett  
University of Washington  
MEB, FU-10  
Seattle, WA 98195

Oxygen consumption calorimetry is now widely used to determine the quantity of heat released by a burning material or materials configuration. This information has been used to improve material selection and hazard analysis. The fire hazard of materials is primarily associated with the heat and toxic products given off directly by their burning in a fire. An additional fire hazard comes from the products of incomplete combustion and the excess pyrolyzate present in some fire plumes. These energetic fire gases (and particulates) may become concentrated in a ceiling layer or may travel to connected spaces where additional combustion can occur.

In this work the potential energy release of fire gases has been characterized with a specialized reactor and oxygen consumption calorimetry techniques. The gases are drawn through a catalytic reactor designed to promote complete combustion. The oxygen consumption is measured across the reactor and related to the potential for heat release. Characterization is in terms of the heat release potential per unit volume of the fire gas. The raw oxygen concentration data obtained with this technique is also useful in characterizing the fire gas. By bringing the gas to a thermodynamic end point, complete combustion, a baseline is established by which to judge other measurements such as CO or CO<sub>2</sub> concentrations. The thermodynamic end point also provides a method for determining the original fuel/air equivalence ratio of the burning material.

Data is presented from demonstration experiments with an intermediate scale fire enclosure. Potential heat release and oxygen consumption data is compared with temperature, CO, and CO<sub>2</sub> measurements. The design and operation of the catalytic reactor is discussed.

# FIRE GAS CHARACTERIZATION VIA POTENTIAL OXYGEN CONSUMPTION CALORIMETRY

by:

**David S. Morrison\***

Advanced Systems Technology  
2121 Crystal Drive, Suite 514  
Arlington, VA 22202

**Richard C. Corlett**

University of Washington  
MEB, FU-10  
Seattle, WA 98195

## EXTENDED ABSTRACT

### **Motivation**

The fire hazard of materials is primarily associated with the heat and toxic combustion products released directly by a burning or smoldering item. An additional fire hazard comes from the secondary burning of energetic fire gases and aerosols. Incomplete combustion products, excess pyrolyzate and free pyrolyzate are three sources of secondary energetic material.

Fires typically do not achieve complete combustion. One result is incomplete combustion product plumes emanating from burning or smoldering items. Another result is production of excess pyrolyzate. Excess pyrolyzate is combustible gases not consumed in the flame which produced them<sup>1</sup>. Free pyrolyzate is produced from items that are not burning. The heat flux to the item may come from a nearby burning item or something hot contacting the item.

Energetic fire gases may become concentrated in a ceiling layer above their lean flammability limit. This can result in rapid flame spread along the layer. Alternatively, the energetic fire gases, even if below flammability limits, can contribute to the heat of combustion at downstream points where additional fuels and ignition sources are present. The secondary burning of fire gases (and aerosols) has the potential to release significant quantities of heat and to spread the fire through a structure.

The goal of this research is to develop equipment and techniques to measure the potential

---

\* Formerly at the University of Washington.

<sup>1</sup> P.J. Pagni and T.M. Shih, Excess Pyrolyzate, *16th International Symposium on Combustion*, The Combustion Institute, Pittsburgh, (1977) p. 1329.

heat release of energetic fire gases. The measurement is to be made in real time from a realistic fire scenario. The potential heat release of collected fire gases is of considerable interest to the Navy, where confined spaces and complex fluid flows may create a significant hazard.

Ultimately, these equipment and techniques may be used for standardized materials tests, for research into fire dynamics, or for smart fire detection systems. The impact of solid and liquid aerosols is not considered in this work, but the technology may be applicable to them.

### **Technique**

Oxygen consumption calorimetry is now widely used to determine the heat released by a burning material or configuration of materials. The heat released by a burning item is determined from the oxygen it consumes in accordance with Thorton's Rule<sup>2</sup> (13.1 kJ of heat release per gram of O<sub>2</sub> consumed). Potential oxygen consumption refers to the amount of oxygen that would be consumed if a fuel mixture burned to completion.

The potential oxygen consumption technique is aimed not at solid virgin fuels such as wood or plastic, but at the fire gases generated when such materials burn or pyrolyze in an enclosed space. The measurement is made on a gaseous mixture that has the potential to combust and consume oxygen. This mixture may exist far from any flame or it may exist inside a flame zone. The goal of the technique is to determine the potential heat release of the fire gases and provide a useful quantification of the hazard they present.

Whether or not fire gases release all or any of their potential heat during a fire scenario is a complex question. The potential for heat release is not itself a sufficient condition for the occurrence of heat release. Ignitability, flammability limits, and reaction rates all may play a part in the extent of heat release. The relationship between potential heat release and the occurrence of heat release is beyond the scope of the current work.

To determine the potential oxygen consumption of a fire gas mixture, the mixture is sampled and drawn through a reactor. The reactor uses catalytic material and high temperature to promote complete combustion of the fire gases. Oxygen concentration is measured at the inlet and at the outlet of the reactor. The oxygen concentration at the inlet is the actual oxygen

---

<sup>2</sup> C. Huggett, Estimation of Rate of Heat Release by Means of Oxygen Consumption Measurements, *Fire and Materials*, Vol. 4 (1980) p. 61.

concentration of the fire gases and is symbolized AO. The oxygen concentration at the outlet of the reactor is the ultimate oxygen concentration the fire gas mixture would achieve if it completely combusted and is symbolized UO. The difference between AO and UO determines the potential oxygen consumption of the fire gases. Consequently, the reactor is called an oxygen consumption reactor, or OCR.

The potential heat release measurement is presented as an energy density, although it is not the classic thermo-chemical energy of the fire gas. Energy density, symbolized “ $\epsilon$ ”, is the potential heat release in a unit volume of actual, dry fire gas (kJ/L). This is the fire gas mixture as it exists in the sampled fire scenario, before it is brought to complete combustion, but with any H<sub>2</sub>O removed. The removal of water is an artifact of the oxygen concentration measurement, which is typically made on a dry sample. To use the per unit volume basis for heat release, the temperature and pressure of the fire gas sample must be known. The volume basis allows for estimating the impact of a fire gas mixture collected in a ceiling layer or flowing away from the fire origin based on an observed volume, temperature and pressure.

A heat release constant, E, is defined for the amount of heat released per gram of oxygen consumed. By Thornton’s Rule,

$$E = \frac{13.1 \text{ kJ}}{g_{O_2}} \quad (1)$$

In the following analysis all gases are assumed to be ideal. The mass of oxygen per unit volume of dry fire gas mixture, or oxygen density, is a function of the dry oxygen mole fraction and the temperature and pressure of the mixture,

$$\frac{m_{O_2}}{V_{fg}} = y_{O_2} \cdot MW_{O_2} \cdot \left[ \frac{P_{fg}}{\bar{R} \cdot T_{fg}} \right] \quad (2)$$

In Eqs. (2)  $m_{O_2}$  is the mass of oxygen;  $V_{fg}$  is a unit volume of dry fire gas;  $y_{O_2}$  is the dry mole fraction of oxygen in the mixture, and is measured with an oxygen analyzer;  $MW_{O_2}$  is the molecular weight of oxygen;  $P_{fg}$  is the mixture pressure;  $\bar{R}$  is the ideal gas constant; and  $T_{fg}$  is the temperature of the mixture.

Energy density is a function of the change in oxygen density across the OCR. The ultimate oxygen density is subtracted from the actual oxygen density to get the mass of oxygen

consumed per unit volume of actual dry fire gas. However, to be consistent, the oxygen in the fully combusted mixture must be viewed as if it were in the pre-reactor mixture. That is, it must be compared with the total number of moles in the fire gas mixture before the reactor. Between the inlet and outlet of the reactor the number of dry moles in a mass of fire gas will change. This is because of the difference in the total number of reactant moles versus the total number of product moles in many reactions, and because of the removal of water which disproportionately affects the products of complete combustion.

A correction factor for this mole number discrepancy is defined as the ratio of ultimate dry moles to actual dry moles in a unit mass of actual fire gas, or

$$cf = \frac{n_{fg}|_U}{n_{fg}|_A} \quad (3)$$

The correction factor is multiplied by the ultimate oxygen mole fraction to convert it to a pre-reactor basis. The resulting equation for the change in oxygen density is:

$$\frac{\Delta m_{O_2}}{V_{fg}|_A} = \left[ y_{O_2}|_A - y_{O_2}|_U \cdot cf \right] MW_{O_2} \cdot \left[ \frac{P_{fg}}{R \cdot T_{fg}} \right]_A \quad (4)$$

Combining and simplifying Eqs. (1) and (4) gives

$$\varepsilon = \frac{E}{R_{O_2}} \cdot [AO - UO \cdot cf] \cdot \frac{P_{fg}}{T_{fg}} \Big|_A \quad (5)$$

$\varepsilon$  is a function of the measured dry oxygen mole fractions (AO and UO), the correction factor, and the measured pressure and temperature of the actual fire gas. At this stage in the development of the potential oxygen consumption technique the correction factor is assumed to equal one. This factor depends on the type of fuel and its concentration relative to oxidizer, and will vary some over the operating range of the system. Our goal is to determine a suitable average value for the correction factor.

### Demonstration Experiments

The goal of the demonstration experiments was to build and use a measuring system capable of sampling from a realistic fire environment and of following the dynamics of the fire. These experiments do not imply a complete evaluation of the performance of the OCR or the

measuring technique. Rather, they show how a system would be set up and the type of results that would be expected.

The two test materials were an E-glass/vinyl ester composite panel and a pine wood board. The 30 cm by 60 cm specimens were set in a vertical frame and placed inside a fire chamber. The fire chamber is known as the University of Washington/Naval Surface Warfare Center Pressurable Fire Chamber, or PFC. The PFC is a cylindrical steel pressure vessel with semi-spherical end caps. It has an inside diameter of 1.52 m and a total inside length of 1.85 m. One of the end caps is a hinged door, allowing complete access to the inside. Two 15 cm diameter glass portals are provided. The PFC has numerous pressure tight connections for instrumentation, power and fluid lines. PFC fires are small to intermediate in scale, ranging from .03 to 1 m in flame height.

The vertical test panels were heated by the PFC's 30 cm by 60 cm electric radiant panel heater. The heater was 24 cm from the face of the test panel. The fire scenario was intended to model an under-ventilated enclosure where the buildup of fire gases may lead to a flashover type event. No air flowed to the fire chamber during the experiments. In a similar actual fire the radiant heat might be supplied by a nearby pool fire. The radiant panel was used so that any oxygen consumption measurements could be attributed to the test fuel alone.

The OCR is a stainless steel pipe with a total length of 85 cm and an inside diameter of 2.54 cm. The volume of the reactor is 484 ml. This space is filled with 0.297 cm diameter catalyst beads. The beads are platinum coated alumina formulated to oxidize volatile organic compounds. Two heating tapes bring the reactor to an average bed temperature of approximately 550 °C. The catalyst activates at 343 °C and has a recommended maximum operating temperature of 677 °C. The flow through the reactor is approximately 14 L/min of standard air.

Figure 1 is a schematic of the demonstration experiment apparatus. At the top is the PFC with the locations of the test specimen, the radiant heater and the two different sampling probes shown. In the center is the OCR and its sample treatment and pumping equipment. At the bottom of the schematic are the gas analyzers and data acquisition system.

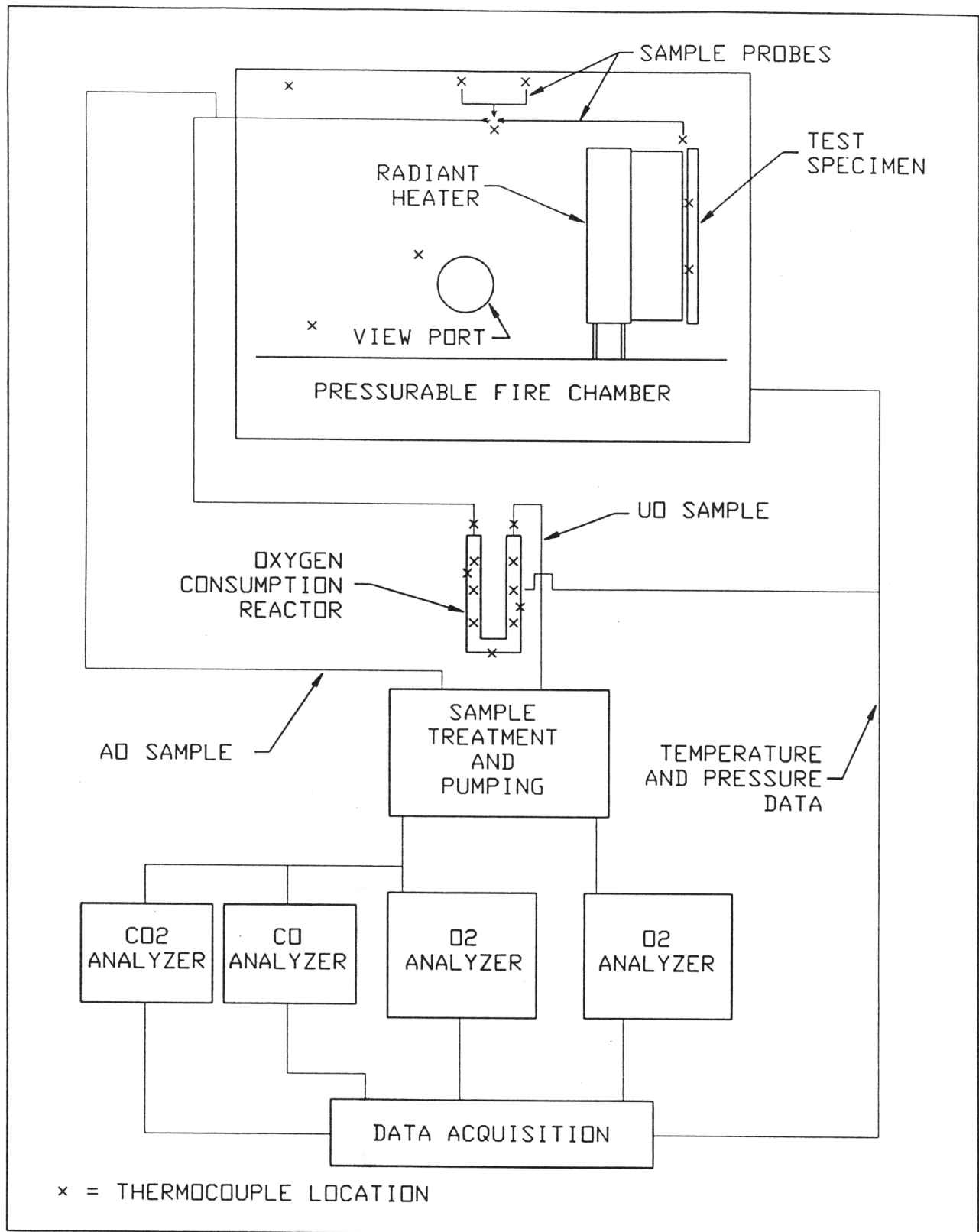


Figure 1  
Schematic of the Experiment Apparatus

There were seven demonstration experiments, six with composite panels and one with wood. The experiments proved that the composite panel fire scenario would lead to a flashover type event. The flashover event divides the fire dynamics into two phases. The first phase is a gradual buildup of energetic fire gases, aerosols and particulates. Then, at a repeatable time, deflagrations course throughout the fire chamber in a flashover type event. The second phase is a sequence of burning and fluid mixing set in motion by this event. Figure 2 is a plot of two measurements made in the fourth composite panel experiment. On the left ordinate is the energy density. On the right ordinate is the CO<sub>2</sub> concentration. The heater started at 120 sec.

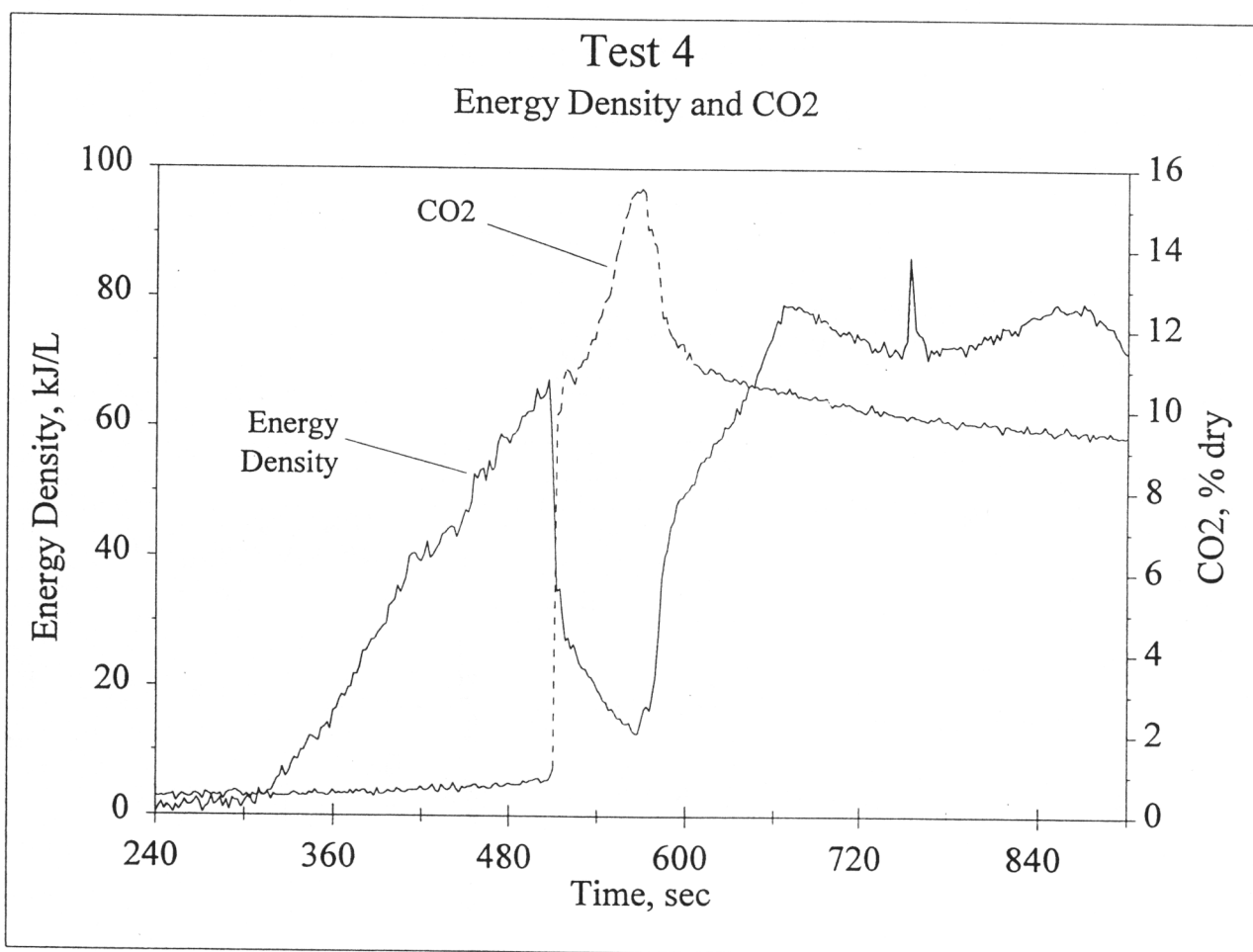


Figure 2  
Energy Density and CO<sub>2</sub>

At 311 seconds into the test the energy density and the CO<sub>2</sub> concentration started to rise from values of 3 kJ/L and .5 % respectively. By 508 seconds the energy density had risen to 68



kJ/L. The CO<sub>2</sub> was only .8 %. At 508 seconds the deflagrations started and the energy density dropped quickly to 32 kJ/L. The CO<sub>2</sub> concentration jumped up to 9.8 %. For the next 53 seconds energy density dropped and CO<sub>2</sub> rose, indicating continued burning.

At 566 seconds the fire dynamics shifted. The CO<sub>2</sub> concentration reached a maximum of 15.5 % and the energy density stopped its fall at 13 kJ/L. After this, CO<sub>2</sub> decreased in an exponential fashion and the energy density rose quite rapidly to 77 kJ/L at 665 seconds. This suggests that as CO<sub>2</sub> production suddenly slowed or stopped, incomplete combustion products were created at the panel or in the tank volume. The oxygen concentration data supports this hypothesis. However, these results may also be due to mixing of highly stratified layers in the fire chamber, most likely a hot, well combusted upper layer with a cool, incompletely burned lower layer. There may have been a combination of production and mixing effects. No measurements were made in the lower levels of the PFC so the data is inconclusive in this regard.

The demonstration experiments were successful in providing quantification of the hazard of fire gases. During the first phase of the fire scenario the increasing hazard is clearly shown. This hazard was born out by rapid temperature rises of between 400 and 900 °C throughout the fire chamber. Later, the energy density shows a lingering threat of heat release. Throughout the fire scenario the energy density data reflects the fast changing dynamics of the fire and correlates well with the measured CO<sub>2</sub> concentrations.

The raw oxygen concentration data obtained with this technique (AO and UO) is also useful in characterizing fire gases and understanding fire dynamics. Reaction rates are concentration dependent and the AO and UO levels provide a indication of how far any oxygen consumption reactions have to go for completion. Bringing fire gases to a thermodynamic end point, complete combustion, establishes a baseline by which to judge measurements of species such as CO or CO<sub>2</sub>. The thermodynamic end point also suggests a method for determining the original fuel/air equivalence ratio of the burning material. This is one avenue for future work.

The complete presentation of this work contains more information on the development and design of the OCR, on the setup of the fire demonstration experiments, and on the results and interpretations of those experiments.

# Use and Interpretation of Calorimetry Data for Fire Predictions

by

James Quintiere

Department of Fire Protection Engineering  
University of Maryland  
College Park, Maryland 20742, U.S.A.

## ABSTRACT

The Cone Calorimeter is a widely used device to measure the mass loss ( $\dot{m}''$ ) and energy release ( $Q''$ ) rates per unit area under a specified external radiative heat flux. The ratio of these two quantities gives the instantaneous heat of combustion ( $\Delta H_c$ ) relative to the gaseous fuel produced during flaming combustion. Generally, during flaming combustion, it has been shown that this heat of combustion is approximately constant for the material. It and other thermo-chemical properties are not expected to be scale dependent. In contrast, the heat flux ( $\dot{q}''$ ) to the material's surface would depend on scale, and on test conditions in the Cone Calorimeter. Hence, it follows that

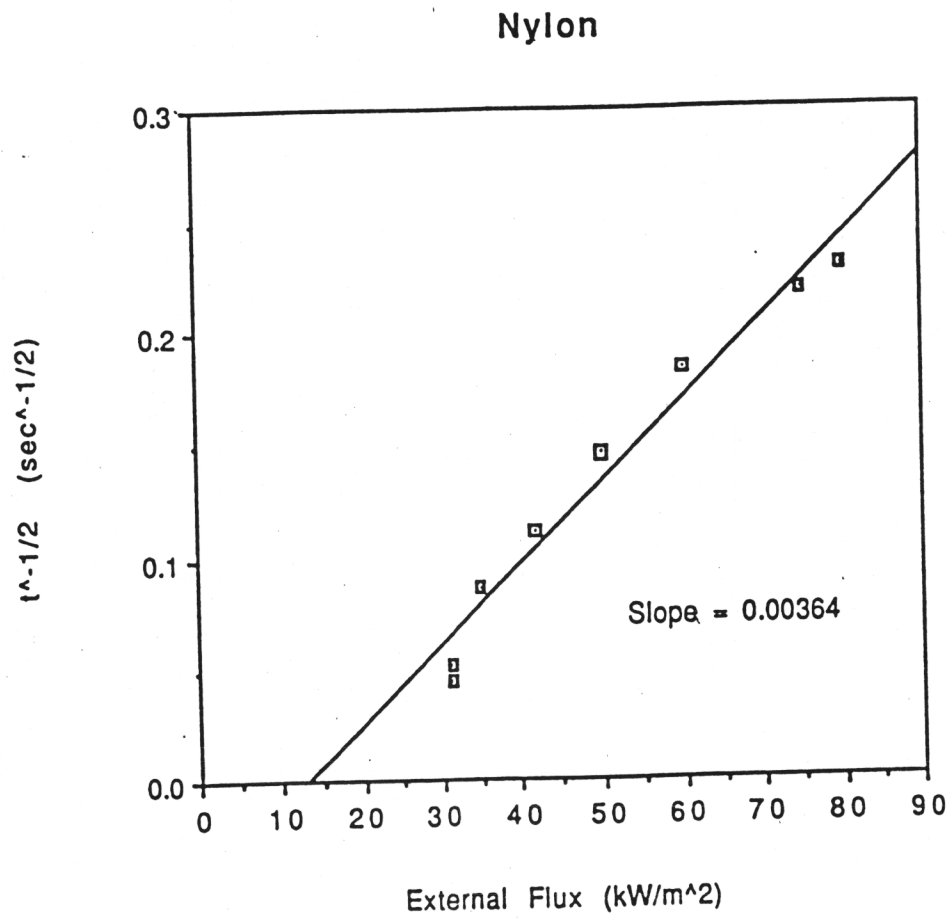
$$\dot{m}'' = f(\dot{q}'', \text{thermo-chemical properties}) \quad (1)$$

$$\text{and } Q'' = \dot{m}'' \Delta H_c. \quad (2)$$

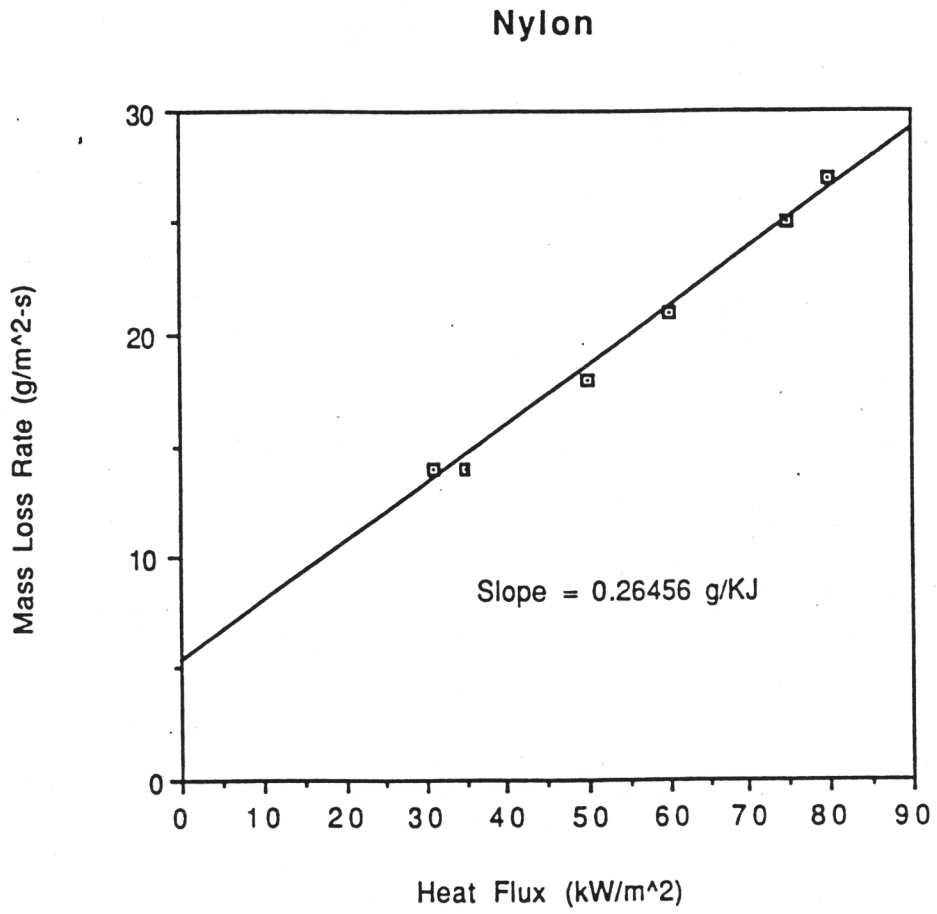
Equation (1) symbolically represents a model involving the surface heat flux and the needed properties. In principle, it should be possible to obtain the thermo-chemical properties from devices such as the Cone Calorimeter. The heat flux is peculiar to the fire scenario. For the Cone Calorimeter, the heat flux consists of the flame and external quantities. These can be deduced from measurements and analysis. Given this information it should be possible to predict the burning rate in the Cone Calorimeter. This will be demonstrated for thermoplastics materials [1]. Also the analysis can be used to deduce the heat flux for more complex fire conditions, such as a pool fire configuration [2]. An extension of Eq. (1) is the prediction of fire growth, including flame spread and ignition. This will be shown for the room-corner fire test scenario for several test variations. Hence, the application of calorimetry property data will be used to predict fire growth and material performance.

### References:

1. B. T. Rhodes and J. G. Quintiere, "Burning Rate and Heat Flux for PMMA in the Cone Calorimeter", presented at the Fire and Materials Conference, Crystal City, VA, October, 1994; and submitted to the Fire Safety Journal.
2. N. Iqbal and J. Quintiere, "Flame Heat Fluxes in PMMA Pool Fires", J. of Fire Protection Engineering, vol. 6 no. 4, 1994, pp. 153-162.



**Figure** Ignition data for Nylon.



**Figure** Steady state mass loss rate of Nylon as a function of external irradiance.

Nylon - 75 kW/m<sup>2</sup>

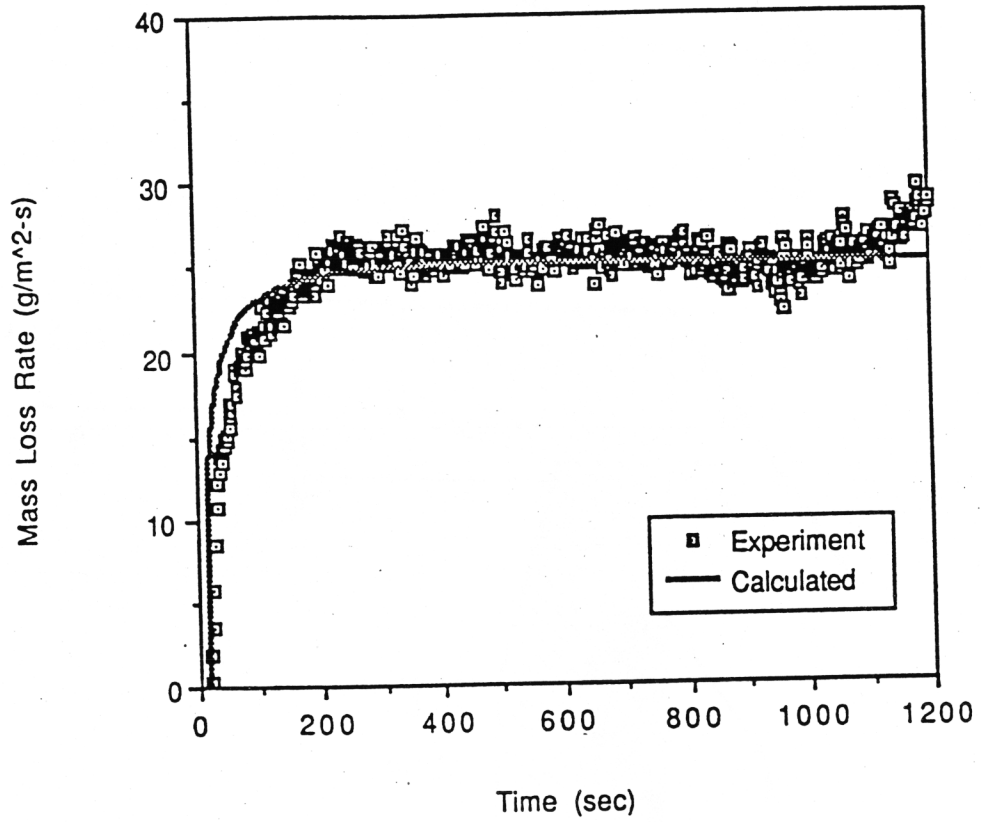


Figure Calculated and experimental transient mass loss rate of Nylon with a 75 kW/m<sup>2</sup> external irradiance.

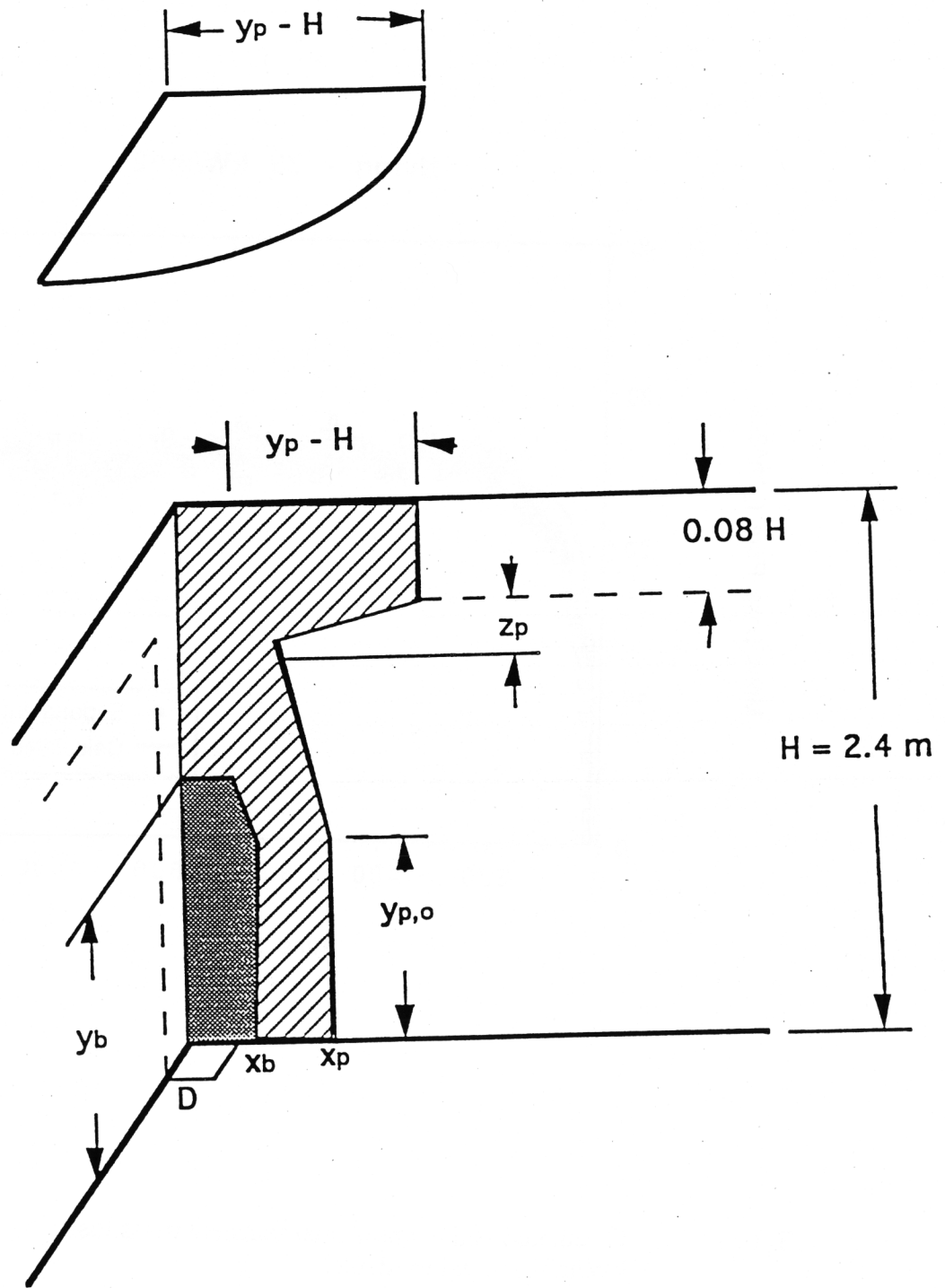


Figure . Simulation model fire growth pattern

$$b = k_f \dot{Q}' - 1 - t_{ig}/t_b, \quad (1)$$

where  $k_f$  is 0.01 m<sup>2</sup>/kW,

$\dot{Q}'$  is the energy release rate per unit area,

$t_{ig}$  is the ignition time associated with upward spread, and

$t_b$  is the burn-out time.

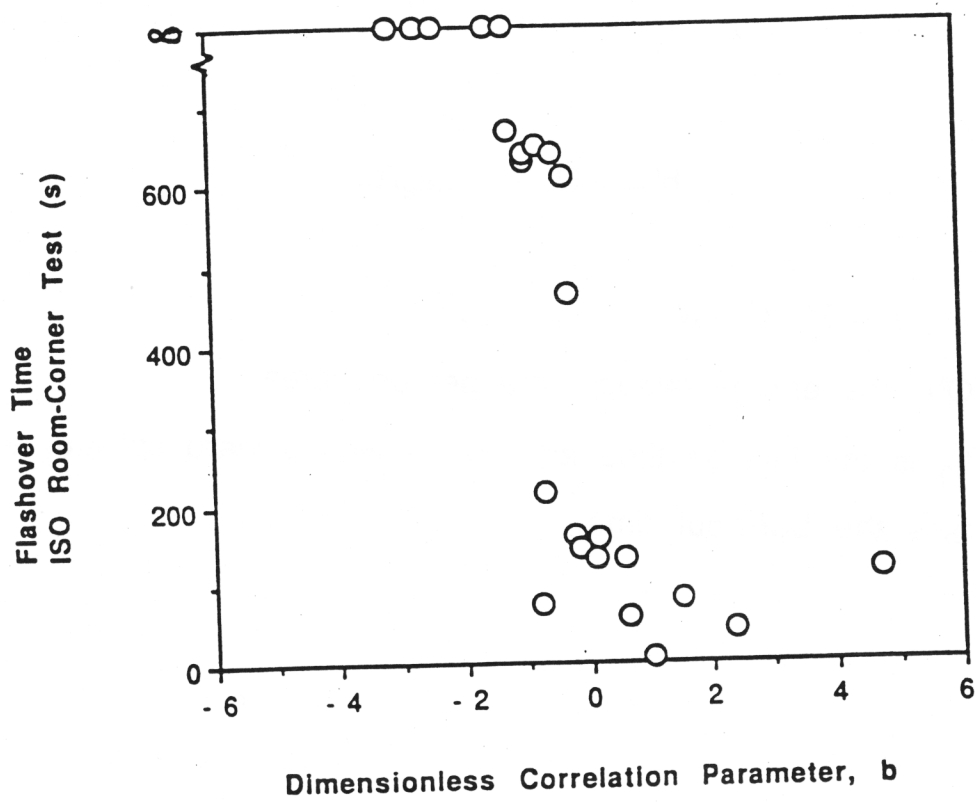


Figure . Correlation of the b parameter and the ISO flashover times



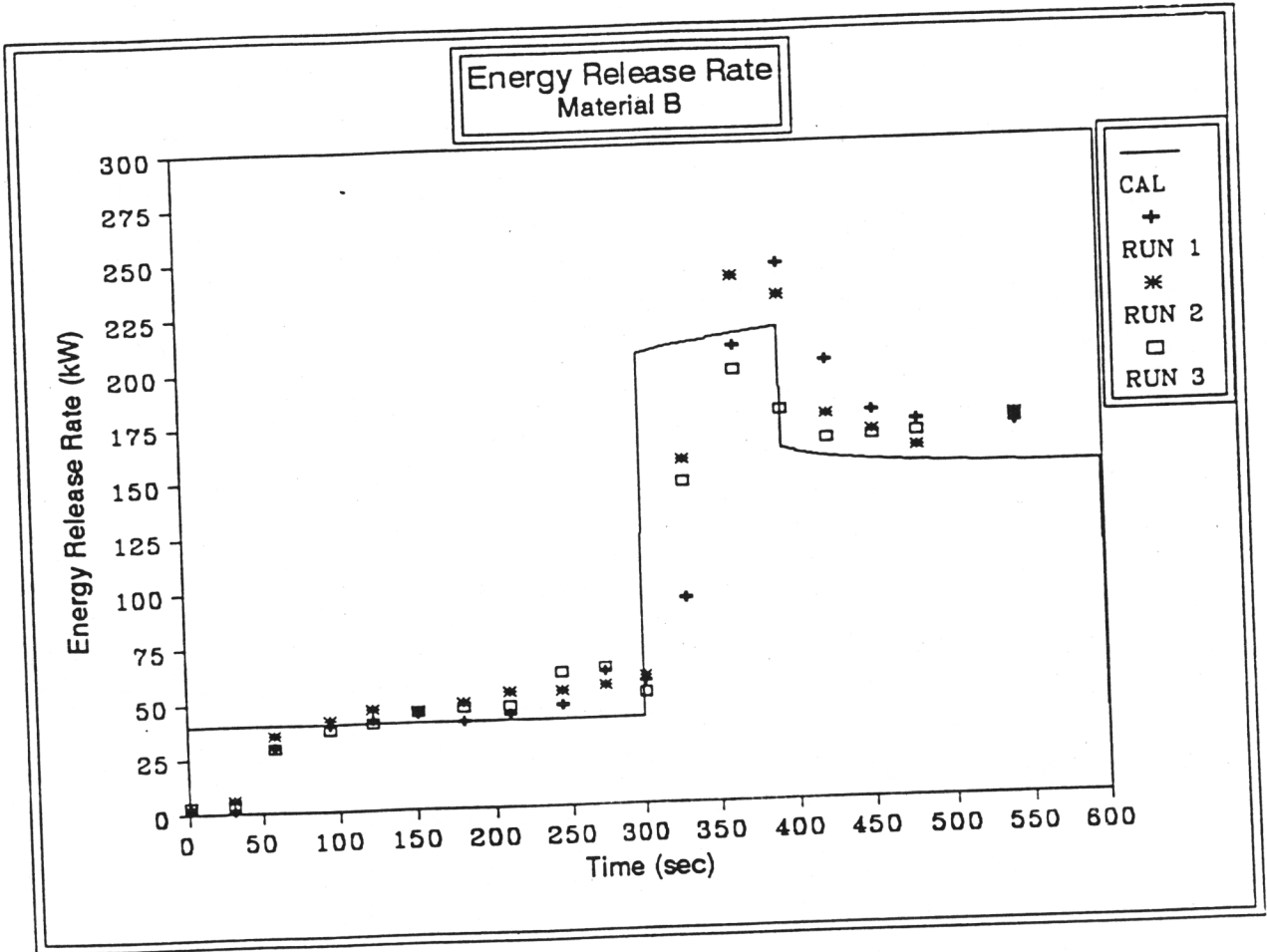


Figure . Energy release rate for sample B in the CBHF room: model and experiment

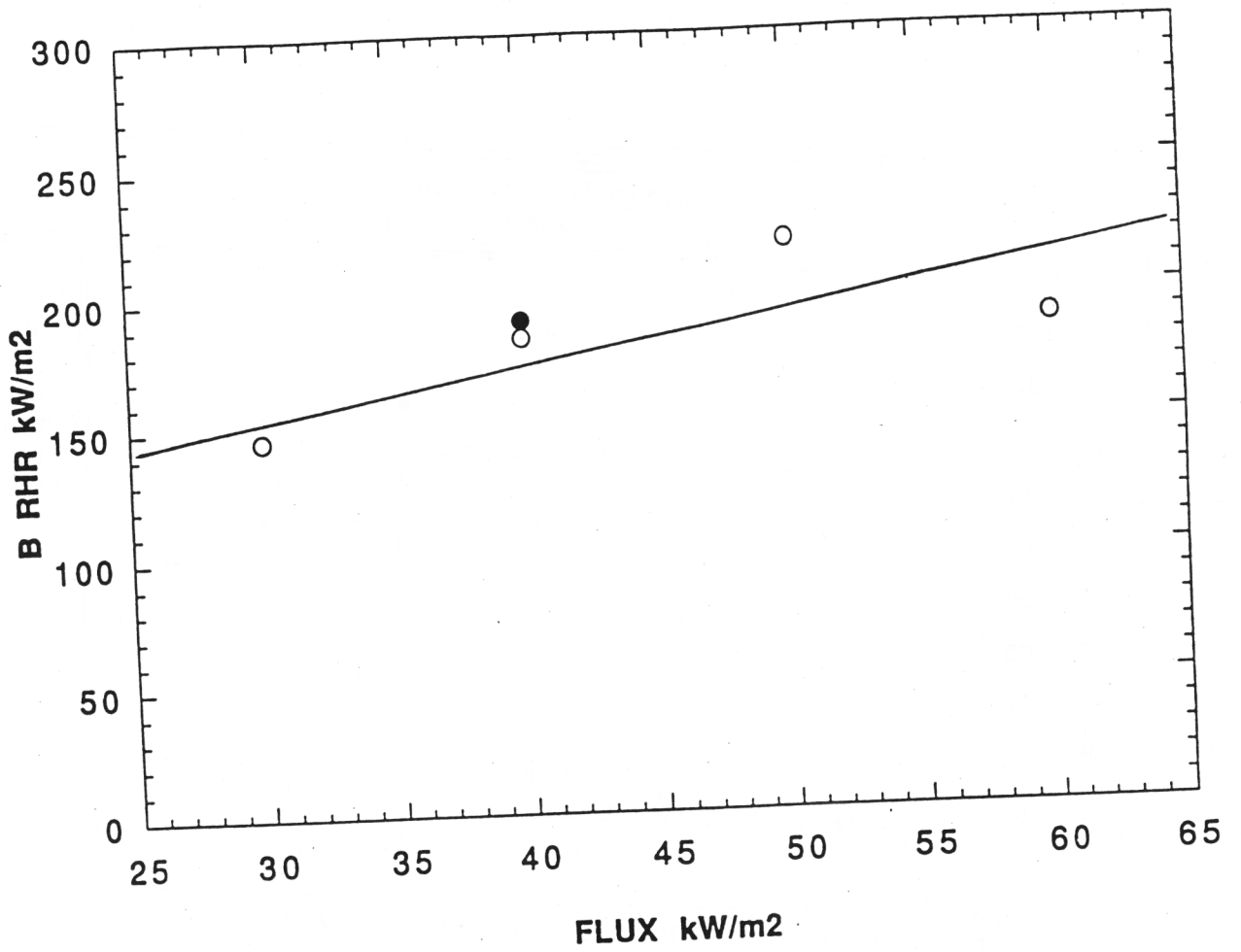


Figure . Rate of energy release per unit area as a function of external radiant heat flux for B (CBHF)

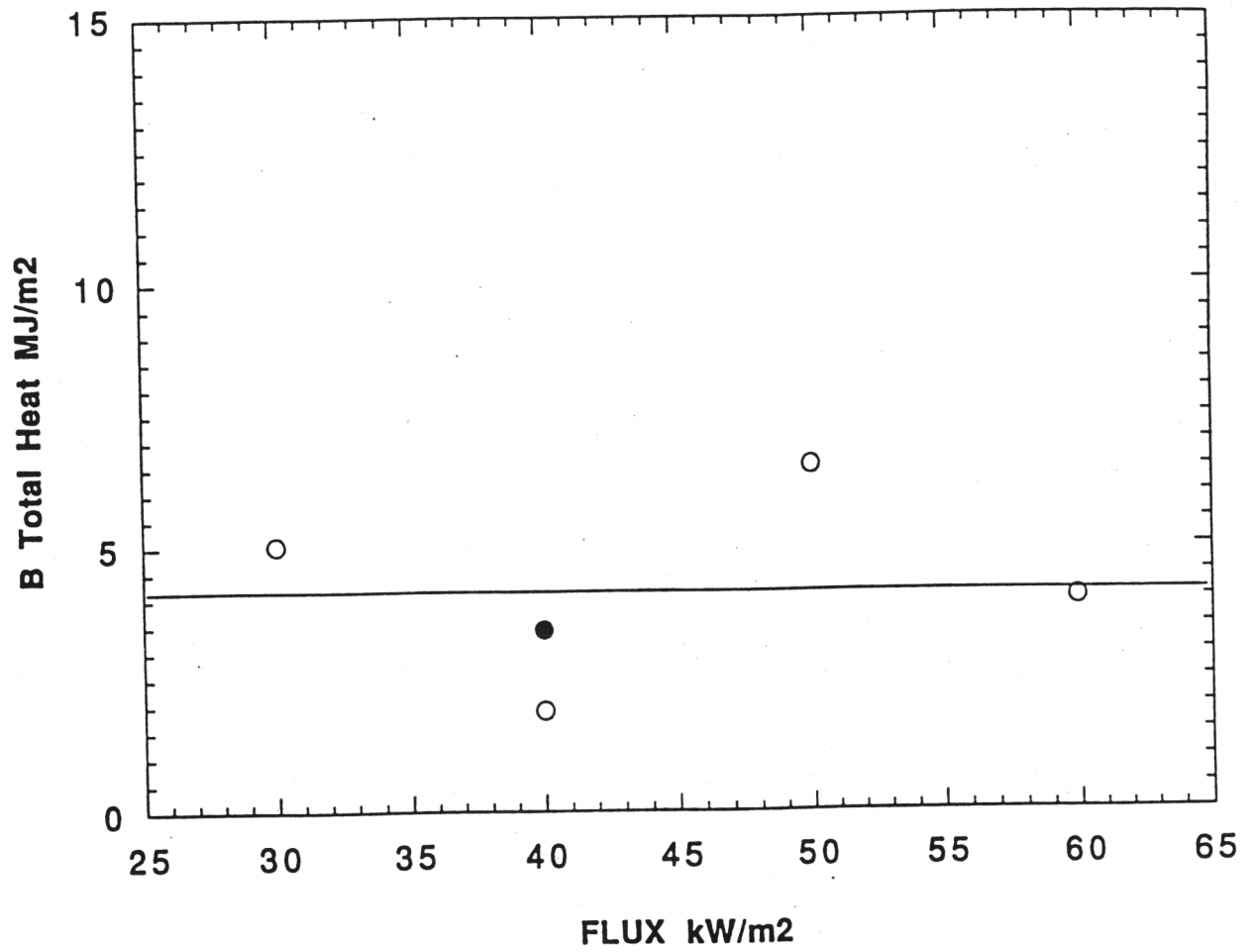


Figure . . Total energy release per unit area as a function of external radiant heat flux for B (CBHF)

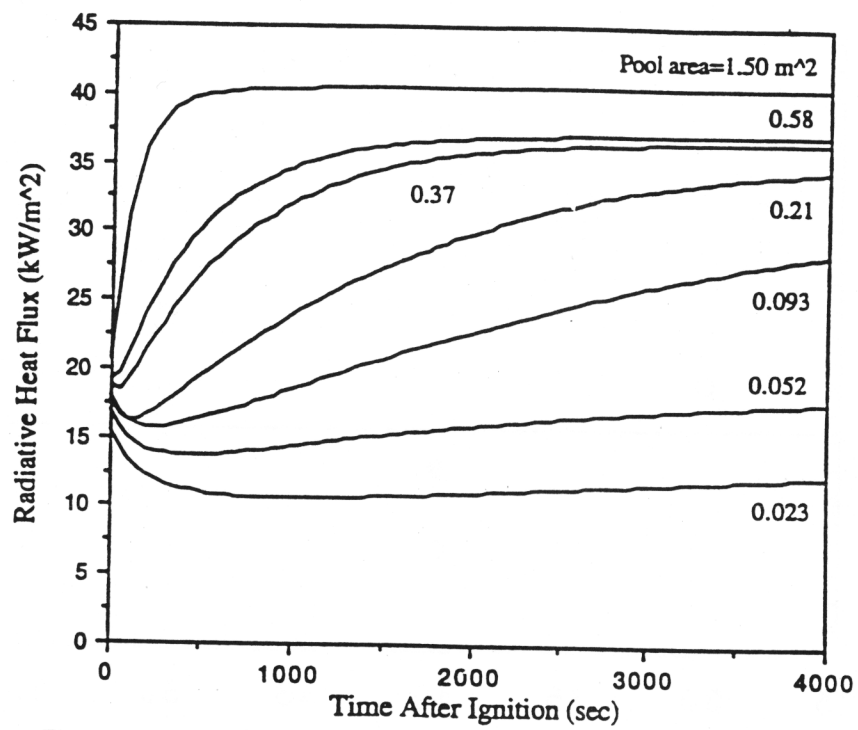


Figure . Computed flame radiative heat flux for seven square PMMA pool fires.

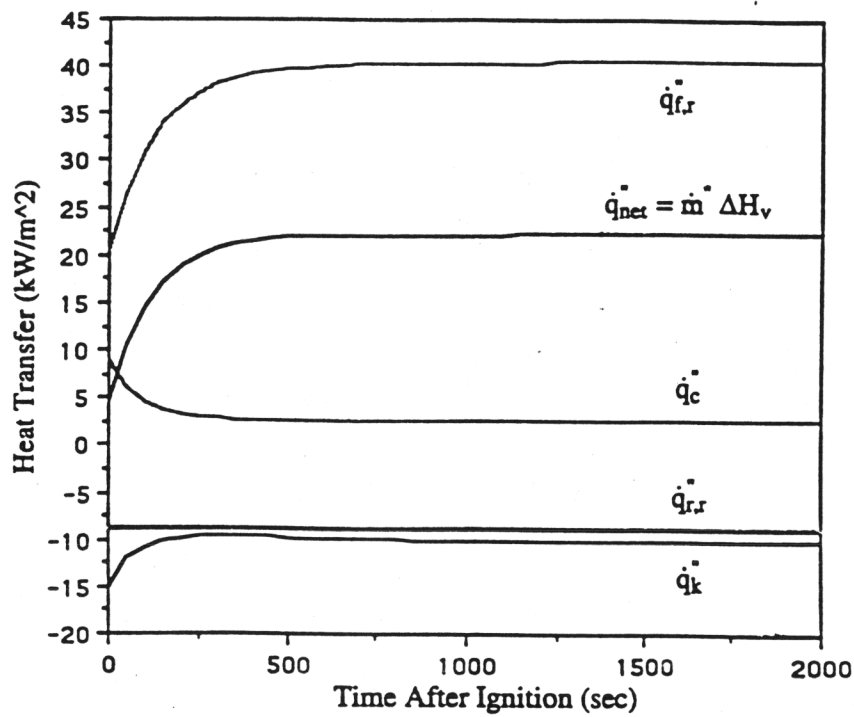


Figure . Heat transfer components for a turbulent pool fire 1.50 m<sup>2</sup> PMMA.

## FIRE GROWTH ANALYSIS USING FIRE CALORIMETRY

C. Beyler, J. Beitel, N. Iqbal, D. Gottuk, M. Peatross  
Hughes Associates, Inc.  
Fire Science and Engineering  
Columbia MD 21045 USA

F.W. Williams  
Center for Safety and Survivability  
Naval Research Laboratory  
Washington DC 20375-5326

The performance of interior finish materials has been investigated using small (cone calorimeter) and large scale (room corner) fire calorimetry methods. This experimental work was supplemented by both correlational and modeling approaches utilizing the data obtained in the cone calorimeter measurements. The work illustrates the value and limitations of the cone calorimeter in the prediction of full scale fire performance.

The full scale fire calorimetry was conducted in a compartment similar to a CPO berthing space. The materials were applied to the bulkheads and overhead of the compartment in the corner of the compartment. A propane gas burner was used as the initiating fire source. The products of combustion were collected via a hood outside the compartment where oxygen consumption calorimetry measurements were made. In addition fire development was documented via videotape and local measurements within the room.

The cone calorimeter results were correlated with the full scale results using an adaptation of the method developed by Mowrer and Williamson. While the form of the flammability parameter was unchanged from Mowrer and Williamson's work, the methods for deducing the properties from the cone data were modified extensively. Based on the modified definition of the flammability parameter it was possible to correlate all the Navy material results and the textile wall coverings data used by Mowrer and Williamson. One material was not well correlated due to the physical behavior of the material which was not well represented in the cone calorimeter. Flame spread modeling of wall fires based on cone calorimeter results is underway. The results of the model for PMMA and wood compare quite favorably with experimental results available in the literature. Critical lessons concerning the use of cone calorimeter results in fire development models have been identified.

## MEASUREMENT OF HEAT RELEASE FROM BURNING AUTOMOBILES FOR CHANNEL TUNNEL HAZARD ASSESSMENT

M J Spearpoint and M P Shipp

Fire Research Station  
Building Research Establishment  
Bucknalls Lane, Garston  
Watford, WD2 7JR, UK

### ABSTRACT

*This paper presents measurements of rates of heat release from full-scale fires in two private motor vehicles conducted under instrumented calorimeter hoods. The work was undertaken on behalf of the Channel Tunnel Safety Unit, Department of Transport, UK. The results were used for the assessment of the specification and design of the shuttle wagons and in the subsequent computer modelling calculations to analyse the impact of such a fire within a shuttle wagon.*

*The fires were well ventilated and allowed to develop fully before fire-fighting intervention. Of the two tests the first burned for 17 minutes with gas temperature in the rig reaching 1250 °C and with a peak total heat output of at least 7½ MW before being extinguished. The other burned for 57 minutes, with gas temperatures reaching 1125 °C and a peak heat output of 4½ MW.*

### INTRODUCTION

The possibility of a fire in a private motor vehicle whilst in transit on a Channel Tunnel shuttle train is a major concern of the Channel Tunnel Safety Unit, Department of Transport (CTSU). At the time of the design of the shuttle wagons, some of the basic information needed to assess the consequences of such car fires was not available. The CTSU commissioned the Fire Research Station (FRS) to conduct full-scale experiments to provide data on the basic fire behaviour of private motor vehicles likely to be carried in the shuttle trains. The objective of the study was to measure the 'worst case' fire behaviour parameters under controlled conditions and with an unlimited supply of air for the fire. Measurements of rate of heat release, temperature, and the emission of smoke and toxic products would provide data essential to the modelling<sup>1</sup> and interpretation of the consequences of vehicle fires in the enclosed environment of a Channel Tunnel shuttle train.

The presentation of this paper includes video footage of the experimental fires. A more detailed analysis of the results is available elsewhere<sup>2</sup>.

## PREVIOUS WORK

Very little experimental measurement has been undertaken on car fires. FRS conducted experiments in 1968 on cars in enclosed car parks in which temperature measurements were made<sup>3</sup>. Similar work has been carried out more recently in Australia<sup>4,5</sup>. Tests have been undertaken in Canada in 1982, in which temperature measurements were made in burning cars but this was to assist arson investigators<sup>6</sup>.

None of this work has examined heat release rates despite the importance of this parameter in designing fire safety systems. Heselden, in a report on smoke movement in road tunnels<sup>7</sup> has estimated a value of 3 MW and this has been widely quoted and used elsewhere<sup>8</sup>. Since the completion of the work described in this paper, Mangs and Keski-Rahkonen<sup>9</sup> have reported on the measurements from three passenger vehicle burns. Peak heat release rates of between 1½ MW and 2 MW were recorded during their tests.

## EXPERIMENTAL DESIGN

### General

The parameters identified above are those that are now recognised by the fire safety community as being of primary importance in assessing the fire performance of materials and assemblies of materials. Although the behaviour of individual materials can be determined by "bench-scale" measurements, it is not always possible to predict how materials will behave when forming an assembly, since the development of the fire will depend on such features as the geometry of the assembly, the interaction between the components, and any interaction with the surroundings.

### Rig design

The calorimeters<sup>10</sup> used to determine the rate of heat release depended upon natural buoyancy to drive the combustion products up the measuring duct. It was originally intended to burn each of the two cars beneath a single calorimeter since initial estimates of fuel load indicated that the single unit would be sufficiently capacious to contain the combustion products. However, once investigations were under way, calculations indicated that the quantity of smoke that might be evolved from a well developed fire in a modern car might in fact overwhelm a single unit. Other available information, such as press reports<sup>11</sup>, supported this view. Consequently it became necessary to use two calorimeters.

It was necessary to design a facility which would reproduce the essential features of the geometry and physical properties of a Channel Tunnel shuttle wagon. At the time of the planning stages for the full-scale experiments, the eventual design of the shuttle wagons had not been finalised and therefore the dimensions and construction of the rig could only be an approximate replication of a shuttle wagon. A canopy was constructed to join two calorimeters as shown in Figure 1. Sheet steel cladding, insulated on the outside with



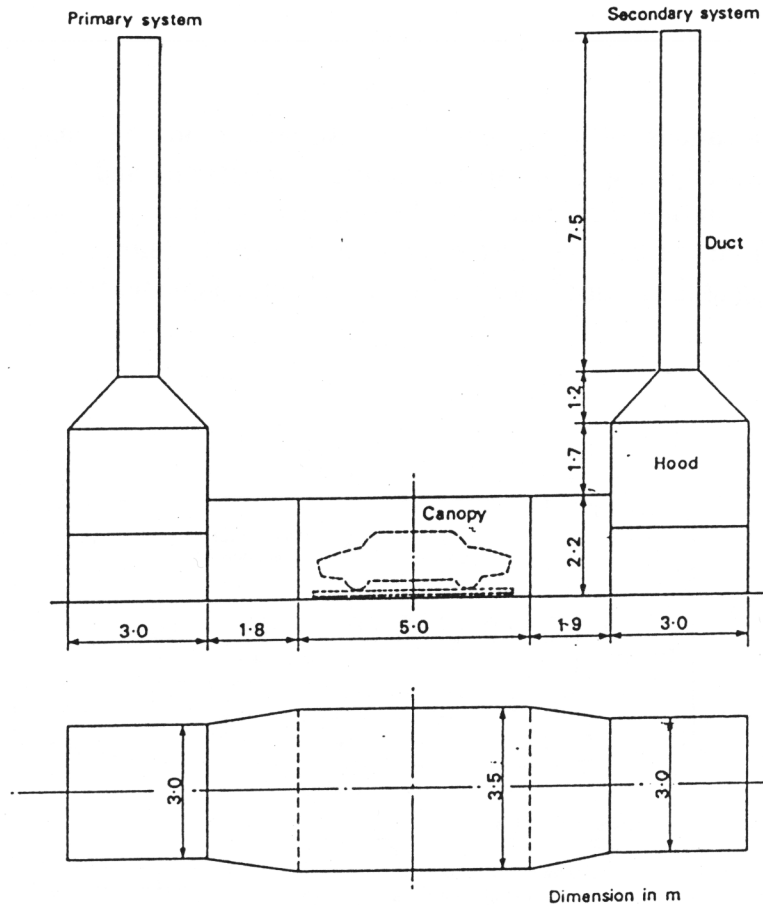


Figure 1. Canopy and duct configuration.

ceramic fibre blanket, enclosed both sides of the canopy over the full height. Although this enclosure tended to reduce the free flow of air to the sides of the car it was considered that this would be outweighed by the more realistic heat feedback that the walls would provide. The steel clad rig provided a surface that would closely resemble the interior of a shuttle wagon and the ventilation conditions thus imposed would be typical of the loading or unloading phases of a shuttle wagon journey.

A carrier for the car was constructed consisting of a tray, intended to collect any spill of flammable material mounted on rails. The presence of this mounting meant that the roof of each car was 170 mm closer to the top of the rig than would be the case in a real shuttle.

#### Instrumentation

The primary calorimeter duct was already fitted with instruments to measure oxygen depletion, gas velocity, gas temperature, carbon dioxide, carbon monoxide and smoke obscuration. The secondary duct was instrumented to measure oxygen depletion, gas velocity, gas temperature, carbon dioxide and carbon monoxide.

The locations of the measuring instruments in the canopy are shown in Figure 2. Thermocouples were located underneath the canopy and in a column by the side of the car to measure the temperature of the smoke layer. Two total heat flux meters were positioned 1 m from the car, one in the wall of the canopy (aimed at the side of the car), the other looking at the front of the car. Further thermocouples were located on and within each car.

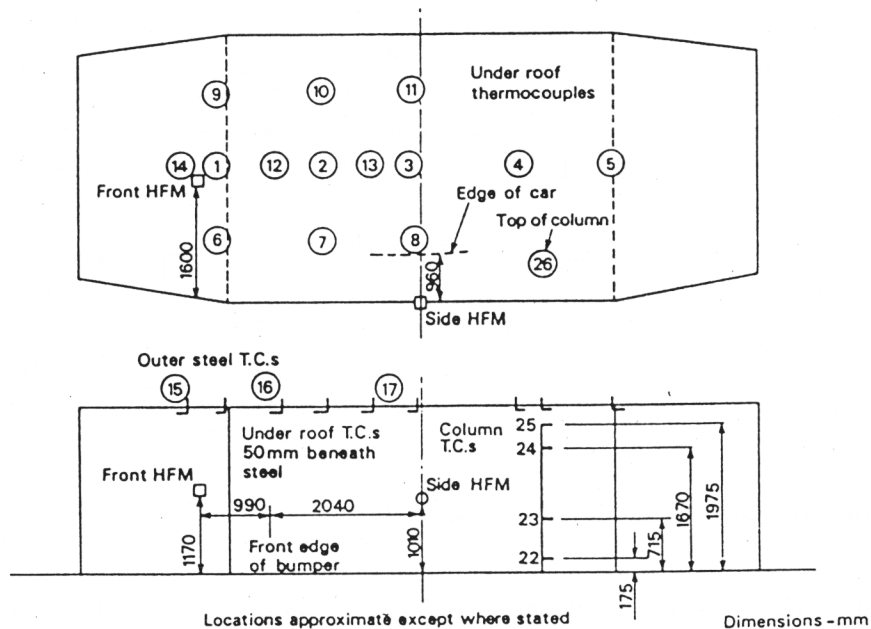


Figure 2. Canopy instrumentation.

### Selection of cars

A review was carried out to examine trends in design and materials so as to determine the type of cars that would be representative of those using the Channel Tunnel. The review involved a survey of available literature and discussions with design engineers and others concerned with the motor industry.

There has been a growing concern regarding car fires in the last few years due to the recent increase in the overall number of car fires reported<sup>12</sup> and there have been a number of studies being carried out to examine this problem. Some of these, and in particular that carried out for the Society of Motor Manufacturers and Traders by the Institute of Consumer Ergonomics<sup>13</sup>, may lead to improvements in design and respecification of materials which may reduce the overall combustibility of cars.

However, findings indicated that there was likely to be an increased use of plastics in car body panel construction, such as glass reinforced plastics (GRP), glass reinforced epoxy (GRE), polycarbonates and rigid polyurethane as a metal substitute. While such materials may not be particularly flammable it might be expected that their fire resistance would be significantly different from steel and that a fire might spread more rapidly.

Following this review of existing designs it was agreed with the CTSU that the two cars would be a 1982 model Austin Maestro and a 1986 model Citroen BX. Both vehicles selected were popular middle range European cars, typical in design and materials usage, and readily available for purchase in a condition suitable for the tests. No other criteria were applied to the selection.

Both cars were fully equipped and drivable. The Maestro was used for the seat ignition test. The Citroen, used for the engine ignition test, had a plastic bonnet and tail-gate. It had some bodywork damage to the rear but this was not significant to its fire performance.

The cars were in a condition representative of those likely to be carried in the Tunnel; they had at least  $\frac{3}{4}$  filled fuel tanks, some luggage in the boot, papers on the seats and dashboard and had their front windows open and doors closed. The suspension system, and other pressurised components, which have been known to explode in fires, were left intact. Batteries were left connected and were fully charged.

### Ignition

Tests were carried out prior to the main test to check how readily the cars might be ignited. For the engine fire (the Citroen) a trial test was carried out on a 1977 model Alfa Romeo Guilletta 1.6 in the calorimeter rig. For this test 0.43 litres of petrol was placed in a aluminium foil tray in the engine compartment. The rate of heat release from the tray of petrol was estimated to be no more than 5 kW. The petrol was ignited with a taper and the bonnet closed. The fire successfully developed.

For the seat fire (Maestro) separate tests were carried out on two other car seats. One was successfully ignited using a No. 7 crib<sup>14</sup> against a split surface covering. The other was ignited using a taper, held where the surface of the seat was damaged. This demonstrated that using a No. 7 crib for the main test would not be unrealistic since the size of ignition source would only affect the initial growth rate of the fire, not its actual occurrence or later development. The rate of heat release from a No. 7 crib was estimated to peak at 10 kW.

## EXPERIMENTAL PROCEDURE AND OBSERVATIONS

### Seat fire (Maestro)

The car's engine was warmed up and switched off about 10 minutes before ignition of the fire to allow the carbon monoxide to clear from the instruments. The driver's seat was slashed by a vertical and horizontal cut about 400 mm long. The No. 7 crib was then used to start the fire.

The fire developed quite quickly with flames visible inside the car after about 1 minute. The fire then grew very rapidly involving the whole interior after 6 minutes and spread to the rest of the car by 11 minutes.

After 4 minutes short-circuiting within the dash panel resulted in the horn sounding and lights coming on and, at 5 minutes the starter motor started. A substantial fire formed in the tray beneath the car. This appeared to consist of molten plastic and engine fluids. The fire grew in intensity until after about 13 minutes, there was a notable increase in fire size which appeared to be due to a spill of petrol. Some of this burning material spilled off the tray onto the floor of the rig. The size of the fire at this stage resulted in an overflow of smoke from the rig and also in the loss of some instrumentation since the flames were getting into the ducts. The primary duct data-logging computer overloaded and shut down and some of the canopy thermocouples were destroyed.

The rig itself then became in danger of collapse and the test was terminated after 17 minutes with the fire being extinguished by the fire brigade who, for safety reasons, flooded the petrol tank. It was therefore not possible to measure the quantity of petrol remaining although, when the car was removed from the rig there was a strong smell of petrol, and it was evident that some petrol remained at the end of the test.

Later examination of the car showed that the rubber hose connecting the fuel filler pipe to the petrol tank had been damaged by the fire. This would have allowed petrol to spill directly from the tank and was the likely cause of the intense fire during the latter part of the test.

### Engine fire (Citroen)

Similarly to the Maestro, the Citroen's engine was warmed up and switched off about 12 minutes before ignition. The bonnet was opened and a foil tray containing 400 ml of petrol placed in the engine. Approximately 100 ml of the petrol spilled during this activity. The petrol was ignited with a lighted taper and the bonnet closed. The spilt petrol also ignited and burned off quickly with no evident effect on the development of the fire.

Smoke became visible from the engine almost immediately after ignition and flames could be seen beneath the car due to the spilled petrol. After 2 minutes flames were visible around

the bonnet. Smoke was visible inside the car after 4 minutes and flames appeared from beneath the dashboard after 5 minutes. The fire then spread through the whole car.

However, this fire never became as severe as that of the Maestro and smoke was successfully contained within the calorimeter hood. Thermocouples remained intact although the oxygen meter and carbon monoxide meter on the secondary calorimeter hood failed and the carbon monoxide meter on the primary calorimeter hood overranged. Once the fire had died down to just a tyre fire it was extinguished by the fire brigade after 57 minutes.

## RESULTS AND ANALYSIS

### Heat release

The rate of heat release in the primary and secondary ducts was calculated using the oxygen depletion technique. At each time interval, the values from the individual calorimeters were summed to provide an overall rate of heat release. The areas under each of the rate of heat release curves were used to determine the total heat release from each of the fires.

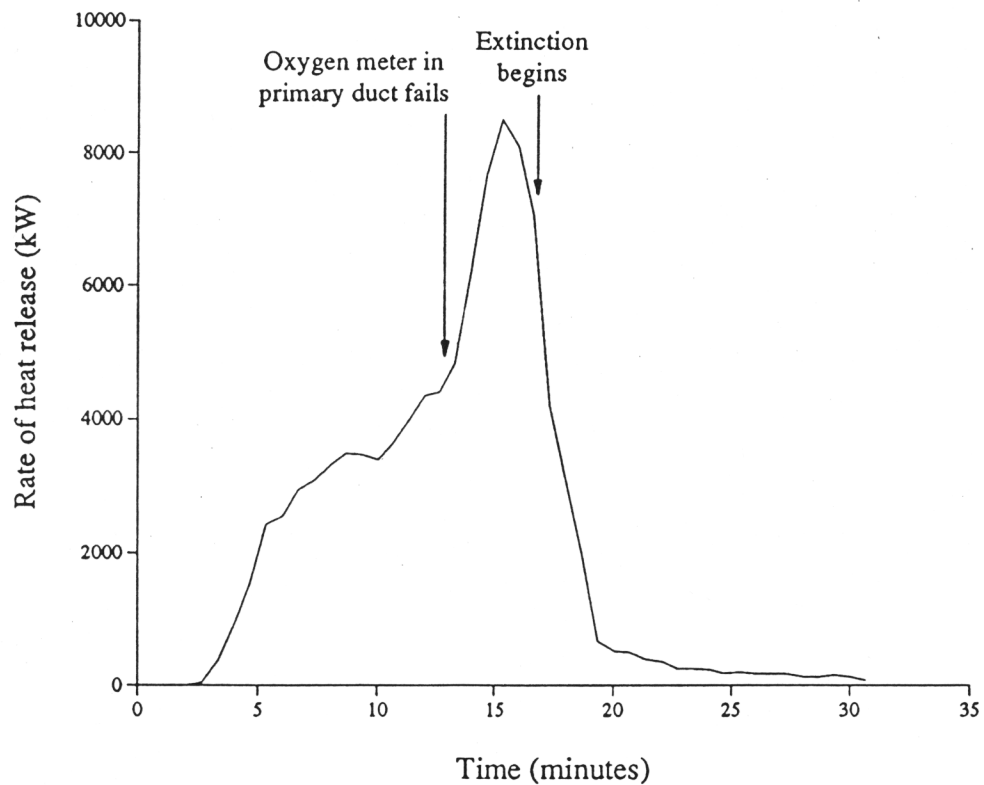


Figure 3. Rate of heat release - Maestro test.

In the Maestro fire, the loss of the primary calorimeter hood data-logger after 13 minutes required that alternative means be employed to estimate the heat release rate after this time. By assuming that the ratio of carbon dioxide to oxygen depletion in the primary duct was the same as in the secondary duct, an estimate of the oxygen concentration in the primary duct could be made.

Thus, the Maestro gave a total value of around 4 MW during 'normal' burning and a peak rate of heat release value of at least  $7\frac{1}{2}$  MW was recorded with an estimated maximum of  $8\frac{1}{2}$  MW (Figure 3) when petrol became involved. However, as noted earlier, there was considerable spillage of smoke from the rig during the severe stages of the fire and the above are estimated to be minimum values. The total heat release from the Maestro was 4010 MJ.

In the Citroen fire, an estimate was made of the oxygen concentration in the secondary calorimeter using the same technique as employed with the Maestro test. A peak rate of heat release of  $4\frac{1}{2}$  MW was thus derived (Figure 4) and the total heat release from the Citroen was 4960 MJ.

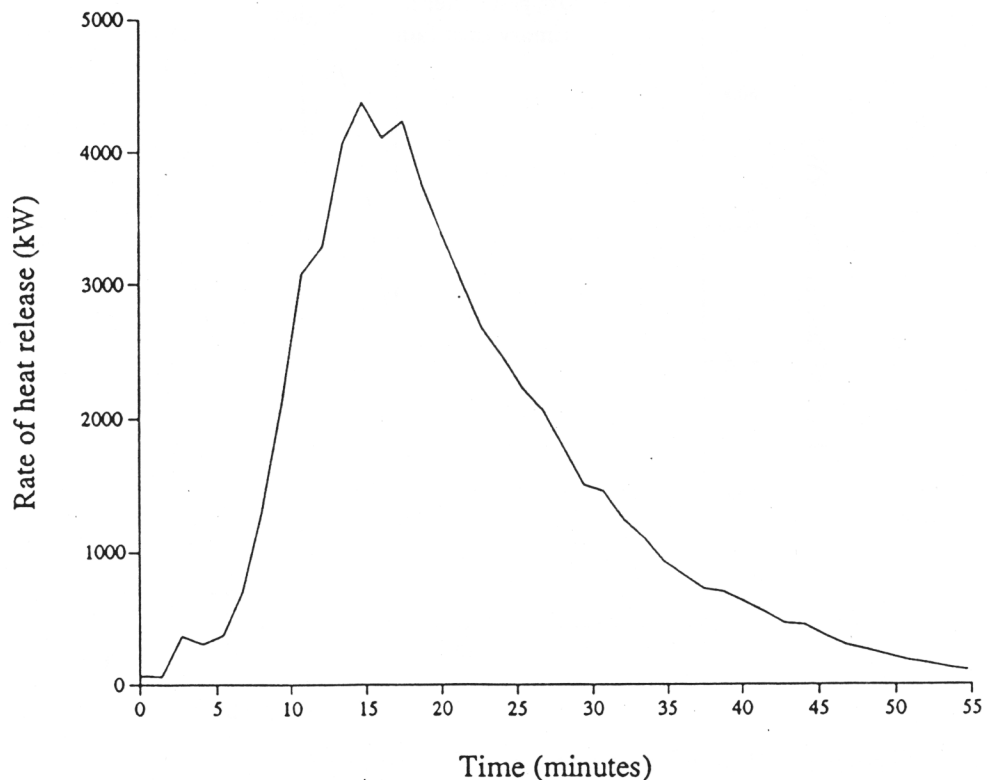


Figure 4. Rate of heat release - Citroen test.

In considering these values it is of note that the Citroen burned for 57 minutes. The Maestro was extinguished by the fire brigade at 17 minutes, but probably would have burned out much more quickly in any case.

### Temperatures

Figures 5 and 6 show the temperatures from selected canopy thermocouples for the Maestro and Citroen fires respectively. Temperatures within the rig were similar in both tests with typical peak temperatures near the roof of 1100 °C and diminishing further away to a gas temperature of 300-400 °C. However during the later intense burning of the Maestro temperatures of 1200 °C were measured. This phase of the Maestro fire appears to be dominated by the burning petrol spill which was absent from the Citroen fire. Temperatures within and on the cars are similar to those outside with the interior reaching 1000 °C or higher as flames enter the car.

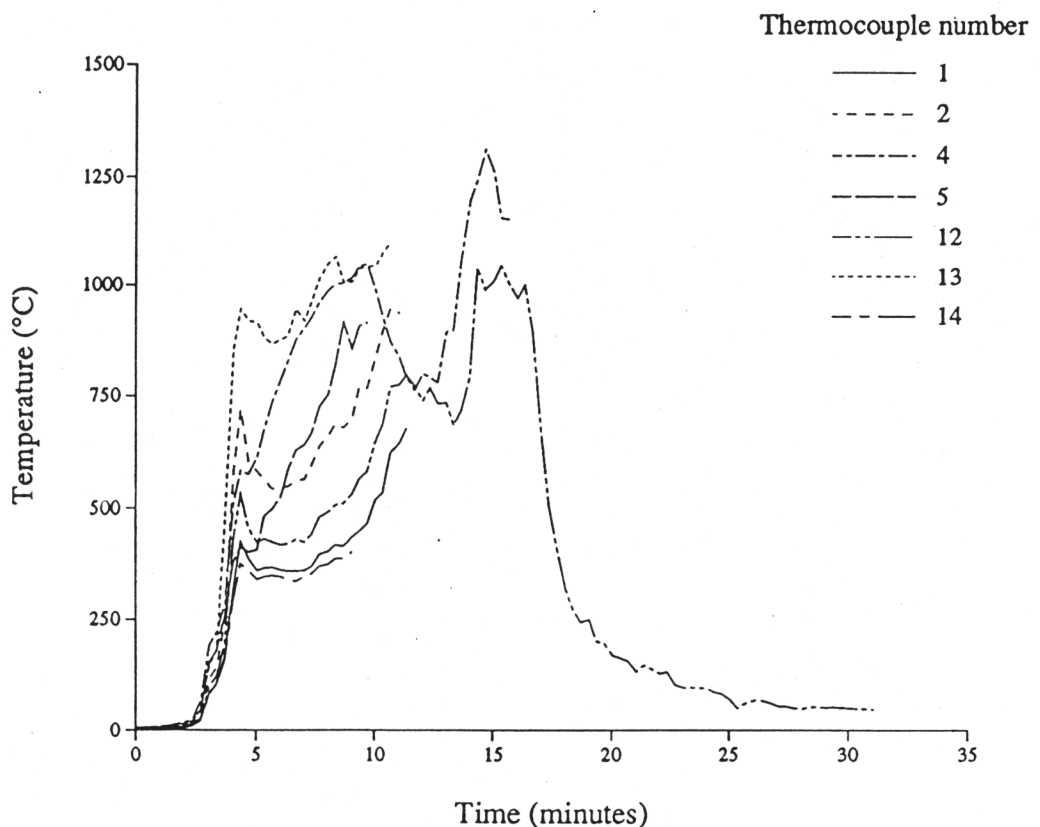


Figure 5. Canopy thermocouples - Maestro test.

### Heat flux

The heat flux measurements show the same patterns of development that can be seen on the other instruments. The values start to rise after 2 minutes (Maestro) and 5 minutes (Citroen)

to around 20-40 kW/m<sup>2</sup> (Maestro) and 40-60 kW/m<sup>2</sup> (Citroen). The Maestro values rose to a peak of 60-80 kW/m<sup>2</sup>. Since most combustible materials will ignite at irradiances above 20 kW/m<sup>2</sup> it follows that in both fires another car situated about 1 m from the test car could ignite after around 10 minutes. Combustible materials on the walls of the rig would have burned after 5 minutes and 10 minutes.

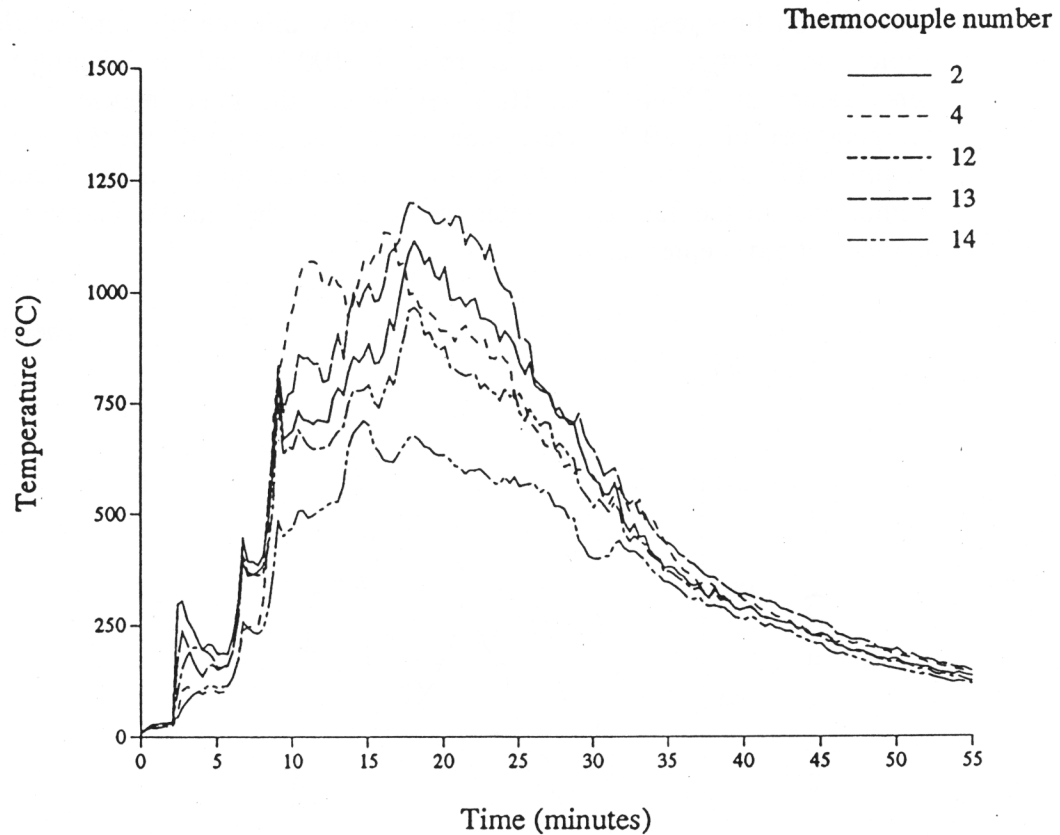


Figure 6. Canopy thermocouples - Citroen test.

### Smoke and gas analysis

In considering the smoke and gas analysis readings it needs to be remembered that the readings are taken in the ducts and some dilution may have taken place between the fire and the sampling point.

In both fires optical densities of around 2.5 per m were recorded before 5 minutes from ignition. During the two tests, peak values of around 2.5 to 3 per m were obtained. Since an OD per m of 1 (an approximate visibility of 1 m) presents a hazard to escape and a value of 1/10th of that (ie. OD .1 per m - approximately 10 m visibility) is usually considered to be the critical point at which visibility starts to become impaired, it follows that the smoke density in the rig itself would have reached hazardous values in less than 5 minutes.



Measurements showed carbon monoxide levels of at least 0.2% to 0.4% being reached in around 5 minutes and carbon dioxide concentrations of 2% to 7% being reached between 8 and 15 minutes.

## **DISCUSSION**

### **Limitations**

In considering the results of the tests presented above it needs to be stated that the fires were conducted under a specified set of conditions which will have influenced their development. These include:

- (i) The rig formed an enclosure around the cars. As this was very well insulated there would have been substantial heat feed-back from the hot walls, as well as the direct feed-back from flames during the high burning rate periods of the tests.
- (ii) The ends of the rig were open. During the early stages of each test, and later towards the end, there would be little restriction on the flow of air to the fire. Conversely, during peak burning, when flames were very long under the roof of the rig, there would have been some restriction of air reaching the centre of the fire.
- (iii) Only one car was burnt at a time. Had other cars been parked near these would have certainly ignited adding to the severity of the fire.
- (iv) The front windows of the cars were open. This would have influenced the growth of the fire in the passenger compartment.

The Maestro fire proved unexpectedly severe. The very rapid growth after 13 minutes, which required termination of the test, also damaged a number of instruments. Some of the instruments could not be repaired in time (the two tests had to be conducted on the same day) and others manifested faults which only became apparent during the Citroen test, since for safety reasons, the instruments were left unattended during the test.

Fortunately it has been possible to make well founded estimates where particular elements of data are missing and, whilst the accuracy of such estimates may be limited, the figures derived, taken with the other data available, provide a comprehensive picture of the growth and development of car fires in enclosures.

### **Comparisons with other studies**

In comparing these findings with measurements from other experiments and theoretical values that have been developed it is evident that the heat release from a single burning car may be significantly higher than those found or assumed elsewhere.

The rate of heat release measurements from Mangs and Keski-Rahkonen<sup>9</sup> showed peak values between 1½ MW and 2 MW. These values are significantly less than the 4½ MW and 8½ MW measured here. The differences in the peak rates of heat release could be due to two main reasons. Firstly, the vehicles used by Mangs and Keski-Rahkonen were of late 1970's manufacture and the materials used and consequent fire performance may differ from those in the more modern vehicles used in these tests. Secondly, the fires were conducted under conditions that would simulate an open car park whereas the tests described in this paper were conducted in a closed canopy. The ventilation and heat feedback mechanisms in the two cases would have influenced the growth of the fire and the consequent peak heat release rates. These differing results demonstrate the range of variables that influence fire development. They include the materials used in the construction of a car; the ventilation conditions in and around the vehicle; the type and amount of luggage in the car and the location of the initial ignition.

The 3 MW peak rate of heat release suggested by Heselden<sup>7</sup> is close to that measured by Mangs and Keski-Rahkonen. Again, this value is significantly less than the peak values measured here.

## CONCLUSIONS

This paper presents the measurements taken from two instrumented car fires which have enabled well founded assessments to be made in the design of the Channel Tunnel shuttle wagons. The tests have shown that the time for a car fire to reach maximum development could be as short as 10 minutes and have a peak heat output of at least 7½ MW. The total heat output could be up to 5000 MJ. Comparisons with other studies shows a significant difference in the peak rate of heat release. The materials used in the manufacture of the different vehicles and the burning conditions may account for these variations.

## ACKNOWLEDGEMENTS

This paper is published with the permission of the Chief Executive, BRE and the Channel Tunnel Safety Unit, Department of Transport. The authors wish to acknowledge all of the Fire Research Station staff who participated in this project including Peter Guy, Bill Maxim and Richard Colwell. The authors wish to thank Mr G Todd (CTSU), Mr A Parr and Mr B Donovan (Kent Fire Brigade) for their assistance and advice. Bedfordshire Fire Brigade provided safety cover for the tests.

## REFERENCES

1. S Kumar. Field model simulations of vehicle fires in a channel tunnel shuttle wagon. *Proceedings of the Fourth International Symposium on Fire Safety Science*. Ottawa, pp. 995-1006 (1994).

2. **Shipp M P, Spearpoint M J.** Measurements of the severity of fires involving private motor vehicles. *Fire and Materials*, **19** (3) pp.143-151 (1995).
3. **E G Butcher, G J Langdon-Thomas, G K Bedford.** Fire and car park buildings. *Fire Research Note No 10*. HMSO, London, 1968.
4. **I D Bennetts *et al.*** Open deck car park fire tests. Report MRL/PS69/85/001. B H P Steel International Group, South Australia, 1985.
5. **I D Bennetts *et al.*** Fire and unprotected steel in closed car parks. Report MRL/PS98/87/001. B H P Steel International Group, South Australia, 1988.
6. **K Allen *et al.*** A study of vehicle fires of known ignition source. International Association of Arson Investigations. Alberta Chapter. Edmonton, Alberta, 1983.
7. **A J M Heselden.** Studies of fire and smoke behaviour relevant to tunnels. *BRE Current Paper 66/78*. BRE, Borehamwood, 1978.
8. **J A Gonzalez, N H Danziger.** Tunnel ventilation design for fire safety. Paper J2, Sixth International Symposium on the aerodynamics and ventilation of vehicle tunnels. Durham, UK BHRA 1988.
9. **J Mangs, O Keski-Rahkonen.** Characterization of the fire behaviour of a burning passenger car. Part 1: Car fire experiments. *Fire Safety Journal*, **23** 17-35 (1994).
10. **Anon.** Upholstered furniture: Burning behaviour - full scale test. *NT FIRE 032*. NORDTEST, Helsinki, Finland, 1987.
11. **Anon.** Complete Guide to Car Fires. *Fire Prevention* **229**, 16-17 (1990) .
12. **Summary of Fire Statistics UK 1989** Home Office Statistical Bulletin Issue 38/90. HMSO 1990.
13. **M Fray, D Southall and I A R Galer.** Reducing the risk of non-electrical car fires. Society of Motor Manufacturers and Traders Ltd, 1991.
14. **British Standards Institution.** Fire tests for furniture - Part 2. Methods of test for the ignitability of upholstered composites for seating by flaming sources. British Standard BS 5852 : Part 2 : 1982.

Flammability Properties for Polymeric (Plastic)  
Materials: An Engineering and Scientific Approach

by

M. A. Delichatsios  
Factory Mutual Research Corporation  
1151 Boston Providence Turnpike  
Norwood, MA 02062

## I INTRODUCTION

We outline a material flammability test procedure for the characterization of the fire hazard of arbitrary practical materials. The proposed procedure includes flammability test measurements and their use, through mathematical models, in predicting, quantifying, and thus, classifying the fire hazard of materials. The proposed set of measurements includes measurements that are being performed in existing flammability apparatus, although not all proposed measurements are currently being performed in the same apparatus. The mathematic models employ these test measurements for deducing key material flammability properties and then predicting fire spread and fire growth for different orientations and geometries such as horizontal (top floor or ceiling), vertical and channel or duct flows.

## II IDENTIFICATION OF BASIC MATERIAL FLAMMABILITY PROPERTIES AND THEIR MEASUREMENTS

We discuss the flammability properties associated with the solid and gaseous phase, respectively, which are directly relevant to flame spread.

The phenomena that are related to the solid phase are the heat-up history and the pyrolysis history of the material. The pyrolysis of a solid material is a chemical and physical transformation from solid phase to gaseous phase, or from solid phase to gaseous phase and remaining char material. The pyrolysis can be enhanced by surface oxidation or be primarily a thermal decomposition process. Such a transformation can be described by an Arrhenius expression as a surface or a volumetric decomposition reaction. This reaction for common (non-explosive materials is endothermic, and the associated energy is called heat of pyrolysis.

The phenomena that are related to the gaseous phase include: a) ignition of the pyrolyzing gases; b) combustion of the pyrolyzing gases; c) flame radiation; and d) products of pyrolysis and combustion. Ignition (and gaseous extinction) involves a premixed fuel-oxidant situation, while the other gaseous phase related phenomena involve a non-premixed (diffusion flame) fuel-oxidant situation.

Both these solid and gaseous phase phenomena affect flame spread (upward vertical, lateral, creeping flame spread) and the growth of the fire for any given geometry (e.g., corner, channel) and size of the fire. The ability to describe these phenomena leads directly to the fire and smoke hazard classification of polymeric materials. Until now, fire hazard material classification has relied mostly on (numerous) comparative flammability tests (different throughout the world), which, however, have limited applicability and are many times contradictory among themselves.

To obtain a comprehensive fire hazard classification and fire growth predictions, one must identify material properties (which do not change with fire size) and measure or deduce them from measurements in a flammability apparatus. Because of the large number of materials, the measurements and their interpretation, through physical and mathematical models, should be simple but inclusive. Table I shows a list of such properties, both for the solid and the gaseous phase, together with the method of measurement and the related application for flame spread and/or fire growth.

The pyrolysis process of polymeric materials is approximated by a thermal pyrolysis model, which represents very well experimental results. We remind that a thermal pyrolysis model considers pyrolysis a) to occur at a pyrolysis temperature,  $T_p$ , and b) to require a latent heat of pyrolysis,  $L$ , per unit mass of pyrolyzed material.

Three apparatus are identified here to be required to obtain our objectives for fire hazard predictions and classification:

- a) A flammability apparatus such as the cone calorimeter or the Factory Mutual Research flammability apparatus;
- b) An oxygen index apparatus for creeping flame spread;
- c) A smoke-point apparatus for soot and flame radiation.

The first apparatus<sup>91,2)</sup> can provide: a) the solid phase properties by measuring weight loss and surface temperature histories<sup>(3,4,5)</sup>; b) combustion properties related to products of combustion<sup>(6)</sup>; and c) ignition times. The interpretation of these data (to deduce the properties)

is based on mathematical and physical models for transient pyrolysis (charring and non-charring) and turbulent combustion<sup>9,3,4,5</sup>.

The oxygen index apparatus can provide data for lateral flame spread and limited oxygen for extinction or ignition<sup>(7)</sup>.

Finally, the smoke-point apparatus provides the information to characterize the smokiness of the fuel required to predict flame radiation and smoke yield from fires.<sup>(8)</sup>

### III METHODOLOGY FOR FIRE HAZARD CLASSIFICATION AND FIRE GROWTH PREDICTIONS

Measurements from (existing) flammability apparatus, together with flame spread and fire growth models<sup>(2,3)</sup>, have been used to accurately predict flame spread on vertical walls<sup>(9)</sup>. A similar methodology has been applied for horizontal flame spread, as outlined in Table I, wherein a flow chart diagram shows how to relate measurements from flammability apparatus for predicting horizontal or vertical flame spread.

Horizontal flame spread is driven by the radiation from the flames of the spreading fire, as well as by the conductive-convective fluxes ("creeping" flame spread<sup>(10)</sup>) near the leading edge of the pyrolysis front. Creeping flame spread can be effectively described by interpreting and using results from an oxygen-index apparatus. This work will be presented elsewhere.

### IV CONCLUSIONS

Polymer material properties for predicting flame spread can be deduced from measurements in three apparatus, which can be easily combined in one apparatus:

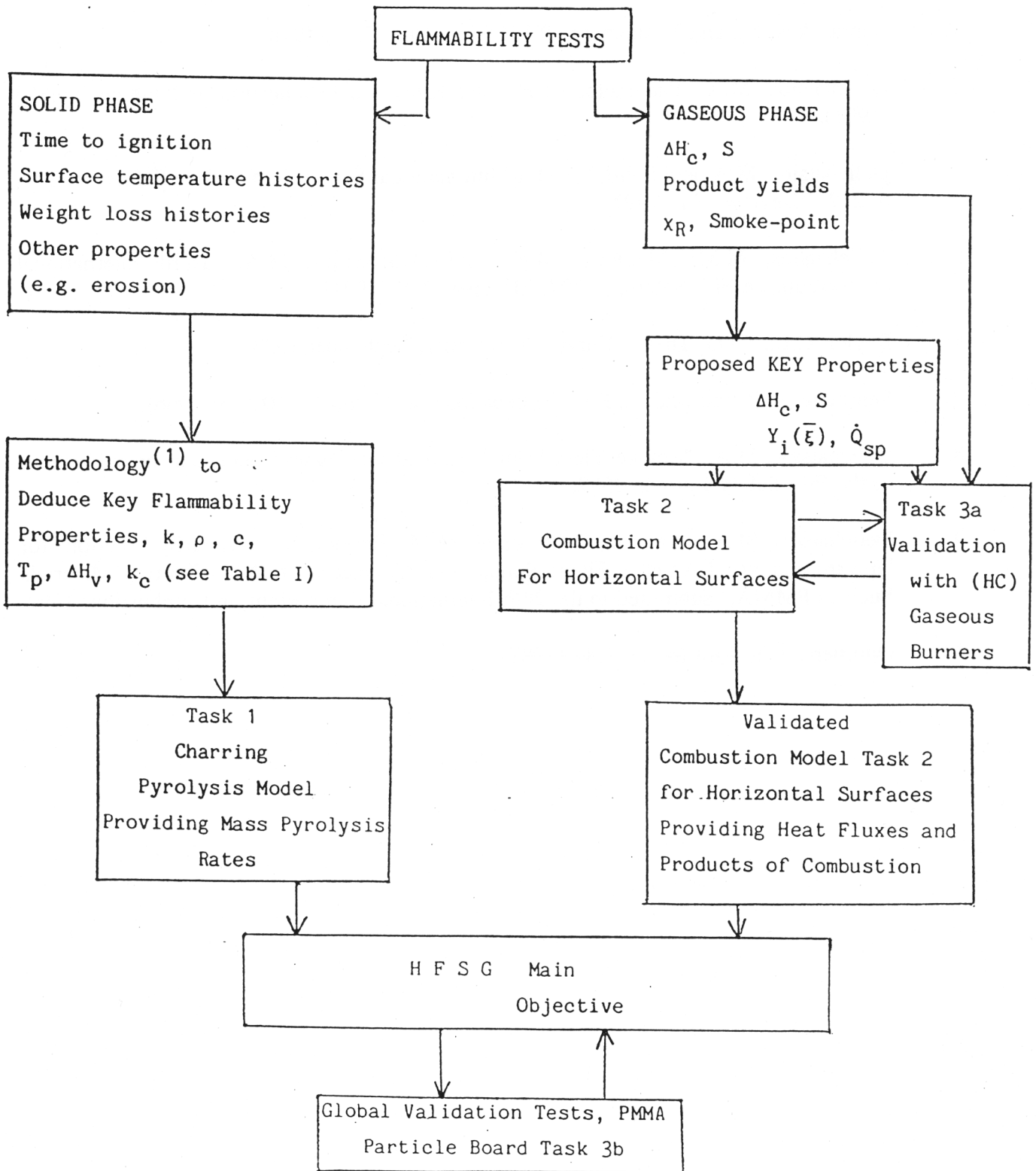
- a) flammability apparatus<sup>(1,2)</sup> (cone calorimeter (NIST), Factory Mutual Research flammability apparatus;
- b) oxygen-index apparatus<sup>(7)</sup>;
- c) smoke-point apparatus<sup>(8)</sup>.

We have outlined a methodology for deducting material flammability properties and predicting fire spread for an upward flame spread as well as for a horizontal flame spread situation (see Table I).

## REFERENCES

1. Tewarson, A., Khan, M.M., Twenty-Second Symposium (International) on Combustion, The Combustion Institute, p. 1231, Pittsburgh, PA, 1989.
2. Babrauskas, V., and Williamson, R.B., *Fire Mater.* 2:39 (1978).
3. Delichatsios, M.A., Panagiotou, T.H., and Kiley, F., *Combustion and Flame*, 84:323 (1991).
4. Delichatsios, M.A. and Saito, K., Third International Symposium on Fire Safety Science, p. 217, Elsevier, NY, 1991.
5. Delichatsios, M.M., Mathews, M.K., and Delichatsios, M.A., Third International Symposium on Fire Safety, p. 207, Elsevier, NY (1991).
6. Beyler, C.L., Ph.D. Thesis, Harvard University, September 1983.
7. Fenimore, C.P. and Martin, F.J., *Combustion and Flame* 10, 10:135 (1966).
8. Delichatsios, M.A., "Smoke Yield from Turbulent Jet Flames," accepted for publication in the *Fire Safety Journal*, 1992.
9. Delichatsios, M.A., Chen, Y., Delichatsios, M.M., Hasemi, Y., "Similarity Solutions for Upward and Wind Assisted Flame Spread and Applications to Non-Charring Materials Such as PMMA," submitted to the 24th International Symposium on Combustion, 1992.
10. Quintiere, J.G., *Fire Mater.* 5:82 (1981).

TABLE I





CORRELATION BETWEEN QUARTER-SCALE  
FLASHOVER FIRE TESTS AND CONE  
CALORIMETER HEAT RELEASE RATES.

David C. Noll and Usman Sorathia  
NSWC Code 643  
1661 Bay Head Rd.  
Annapolis, MD 21401

The purpose of this research is to correlate small scale cone calorimeter rate of heat release data (ASTM 1354) for polymeric and fiber reinforced composite materials, with the data from quarter-scale compartment flashover tests. The U.S. Navy, for the last ten years, has collected an extensive database generated by the cone calorimeter, the radiant panel, the smoke density chamber, and the quarter-scale compartment flashover fire tests, under the category of small and intermediate scale fire tests. Some materials were insulation sheets, damping tiles, and polymeric as GRP and composites modified with fire retardants. Most of these materials have shown heat resistance qualities suitable for ship structures under normal and combat conditions. No correlation has been derived from the small scale fire tests' data to scale them to the larger fire tests.

Some attempts have been made to correlate the cone calorimeter heat release data to quarter-scale flashover<sup>1</sup>. However, no extensive program has been set up to write a program directly relating cone calorimeter heat release or other data, with quarter-scale flashover. The investigators are looking for a program to correlate small "bench" scale tests, as the cone calorimeter, to larger scale fire tests. For example, could cone calorimeter heat release data predict quarter-scale flashover?

Computer modeling techniques could provide an algorithm to predict the fire behavior of materials to avoid the use of some large scale and more expensive fire tests. The large scale fire tests will always be used as the ultimate fire test, however, fire modeling programs could lead to less and more economical testing.

---

<sup>1</sup> Model Name: SPREAD

Predicts the burning and spread rate of a fire ignited on a wall using input data from bench scale tests. Modeler: H.E. Miller, Building and Fire Institute, NIST  
Gaithersburg, MD

CONE CALORIMETER-APPLICATIONS IN FIRE RESISTANT  
MATERIALS CHARACTERIZATION AND DEVELOPMENT

Robert R. Buch  
DOW CORNING CORPORATION  
2200 W. Salzburg Rd.  
Auburn, MI 48611

**ABSTRACT**

Silicones encompass a diverse range of materials which find application in a broad spectrum of applications and industries. Several of these rely extensively on the novel fire behavior of this family of materials. In many other applications/industries, product acceptance is contingent upon fire performance in a "pass/fail" qualification or acceptance fire test. Since 1986, a cone calorimeter has been used extensively in our fire resistant materials development program. This presentation will highlight both the conventional uses of this apparatus and examples of non-conventional uses.

The versatility and efficiency of the cone calorimeter coupled with the array of fire parameters it measures provides the materials development specialist immediate insight into the fire performance (ease of ignition, heat release rate, combustion product parameters) of their materials. Data on a wide range of silicon-based materials will be briefly reviewed. Recent studies at NIST (pool burns)<sup>1</sup> correlate well with earlier cone calorimeter results on dimethylsiloxanes.

In addition to accommodating a broad range of materials, the simulation of a wide range of fire conditions (heat flux conditions) in a tightly controlled manner provides a means for simulating several costly and time-intensive traditional fire tests. Several examples of this capability will be briefly described.

The utilization of fundamental fire parameters for materials such as heat release rate in codes, standards, and fire models is encouraging and welcomed. However, technically sound and reliable test protocols along with the resolution of apparatus idiosyncrasies are in need of attention and resolution.

### Fire Parameters-Materials Characterization

Since its development at the NBS (NIST), the cone calorimeter has been widely accepted as an efficient and versatile fire test apparatus for the characterization of the fire behavior of materials. Since our initial study on the fire behavior of dimethyl-substituted siloxanes<sup>2</sup>, further studies on alkylmethyl substituted siloxanes and polymer structural variations have continued. These studies suggest that for linear siloxane materials, optimum heat release performance is observed for those siloxanes in which both silicon substituents are methyl groups. In general for alkylmethyl substituted siloxanes, the heat release rate increases significantly with the chain length of the alkyl group. The relative insensitivity of HRR on external heat flux characteristic of dimethylsiloxanes appears to be retained in alkylmethyl siloxanes; however, this has not been evaluated over a wide range of external heat flux conditions. For highly non-linear siloxanes (i.e. resinous structures), heat release rate is observed to be largely dependent upon the amount of linear siloxane in the material and the size of the organic substituent and its concentration in the material.

In recent years, several approaches have been used to incorporate the novel fire features of siloxanes into organic thermoplastics and engineering resins<sup>3</sup>. One of the more promising approaches is that developed by Romenesko<sup>4,5</sup>. Substantial reductions in heat release rate of the thermoplastic or thermoset results from the addition of a silicone polymer/silica filler additive to the organic. The cone calorimeter played a key role in the development of this technology.

### Cone Calorimeter-Test Protocol Variables

In virtually all physical/chemical testing of materials, several (perhaps many) factors can influence the measurement of the parameter of interest. The cone calorimeter is no exception. Results of an interlaboratory test program on fluids involving various heat release rate measurement apparatuses suggest that systematic differences between apparatuses together with subtle procedural factors may compromise

fire test data. Resolution of these issues together with established material standards is suggested.

### Fire Test Simulation

At the present time and perhaps well into the future, older, traditional fire test methods will determine the acceptance of new materials. Fire barrier materials, through-penetration fire-stops, and thermal control coatings are typically evaluated by subjecting them to a controlled "time-temperature" regimen<sup>o</sup> or direct exposure to open-flame (e.g. JP-4 fuel flame @2000 F). Utilization of the cone calorimeter to simulate these types of tests enhances the value and utility of this apparatus in a materials development laboratory.

### **References:**

1. Buch, R., Hamins, A., Borthwick, P., Konishi, K., and Kashiwagi, T., Pool Burning of Siloxane Fluids, in preparation, (1995).
2. Buch, R., Fire Safety Journal 17 (1991) 1-12.
3. "New Silicone Technologies for Flame Retardant Wire Constructions", Elastomerics, March, 1987 p.17
4. Romenesko, D. J., et.al., "Silicone-Based Additives for Thermoplastic Resins Providing Improved Impact Strength, Processing, and Fire Retardant Synergy", Fire Retardant Chemicals Association Meeting (Fall), Tucson, AZ, Oct. 26-29, 1993.
5. Romenesko, D. J. et. al., U.S. Patent 5,391,594 Feb. 21, 1995.
6. ASTM Fire Test Standards, 3rd edition, 1990, E-119-88, p. 514 (Appendix X1).

# APPLICATION OF CONE CALORIMETER FOR THE ASSESSMENT OF CLASS OF FLAME RETARDANTS FOR POLYPROPYLENE

**G. Gallina, E. Bravin, C. Badalucco,**

I.C.I.T.E. (Central Institute for Building Industrialization and Technology)

CNR (National Research Council)

via Lombardia 49, S. Giuliano Milanese - 20098 Milano - Italy

**G. Audisio, M. Armanini, A. De Chirico, F. Provasoli**

I.C.M. (Institute of Macromolecular Chemistry)

CNR (National Research Council)

via E. Bassini 15 - 20133 Milano - Italy

## 1. ABSTRACT

The study presented addresses the fire behaviour of three polymeric materials compounded with five classes of flame retardants. The application of cone calorimetry for the assessment of the thermal characteristics of the tested materials and their comparison with thermogravimetry are the central point of this research. The scheduled work involves the study of three materials: polypropylene, polystyrene, polyethylene, mixed with corresponding flame retardants.

The study has three different phases with reference to three different fire conditions. The first phase has a 25 kW/m<sup>2</sup> radiation, the second phase 10 kW/m<sup>2</sup> and the third phase 35 kW/m<sup>2</sup>. Each phase involves five tests for each material tested with no additives and five tests for each material tested with added flame retardants.

The results presented in this study concern the first phase, which allowed for the comparison of different mixtures related to the rate of heat release, effective heat of combustion, mass loss rate, and time to ignition.

Moreover the results obtained by using the cone calorimeter have been compared with the thermogravimetric results contained in a previous extensive research programme. Results represent meaningful comparisons between the behaviour of the materials under fire conditions and in thermogravimetric analysis. These results created new opportunities to study fire behaviour in terms of comparisons between cone calorimetry and other survey systems of the thermal characteristics of materials.

## 2. INTRODUCTION

The basic need of this study is to acquire specific knowledge about the fire behaviour of different classes of flame retardants (FR). The present study was designed to assess the mechanistic effect on combustion and fire retardance of selected flame retardants. Thus, we have tested polymeric materials compounded with different classes of flame retardants based on triglycidylisocyanurate (TGI) and Lignin.

The test methods used were basically thermogravimetry and the cone calorimeter. Thermogravimetry was widely used to assess: thermal stability (a large number of results can be found in the literature [1]), increase in thermal degradation temperature of polymers and increase in char production caused by the flame retardant additive. The ability of a system to produce char during combustion is one of the most important FR additive characteristics, since it reduces the oxygen contribution for the combustion and limits the gas generation of the products.

It has been shown that the rate of heat released by a product is the most important property predicting hazard in a fire situation, because the assumption is that the rate of heat release (RHR) controls the intensity of the fire [2]. The traditional method of measuring and predicting the hazard of materials is based on the determination of a variety of properties independently in different small-scale apparatuses [3]. The cone calorimeter provides a means of measuring, simultaneously, a number of different properties in the same test.

This work was undertaken with the following objectives:

1. To investigate the properties of different classes of flame retardants;
2. To compare the fire behaviour of three polymeric materials compounded with five classes of flame retardants;
3. To establish whether the application of cone calorimetry for the assessment of the thermal characteristics of tested materials can predict real qualitative differences related to combustibility;
4. To establish whether the application of cone calorimetry and its comparison with thermogravimetry is significant for the definition of fire risk properties;
5. To establish whether different calorimetry tests can be compared satisfactorily.

However, it should be pointed out that it is very difficult to evaluate the fire safety of materials by using the results of this preliminary phase only.

### 3. EXPERIMENTAL

#### 3.1 TEST METHODS

##### 3.1.1 CONE CALORIMETER

The rate of heat release is one of the most important parameters for identifying fire risk. The Cone Calorimeter is the most significant of all small scale tests, since it is able to determine rate of heat release associated with a variety of other parameters. The Cone Calorimeter is described in detail in [4-5]. It is based upon the principle of oxygen consumption, which states that the heat released during combustion by a burning specimen is proportional to the total amount of oxygen consumed during the combustion process. This bench-scale instrument is able to determine the rate of heat release by measuring oxygen depletion in the gas flow stream of combustion products and air [6-7-8]. An external incident radiant flux in the range of 0-100 kW/m<sup>2</sup> can be applied, by means of a temperature-controlled heater. In this first stage of the work, the incident radiant flux was set at 25 kW/m<sup>2</sup>. During the test the instrument records the specimen mass on the load cell and the time to ignition [9]. Samples can be exposed in both horizontal and vertical orientations; all of the samples tested in this research programme have been tested under horizontal orientation conditions.

The most important parameters considered are [10-11-12]:

<b>Time to ignition</b>	<b>t ign.</b>
<b>Total burn time</b>	<b>t tot.</b>
<b>Rate of heat release</b>	<b>RHR</b>
<b>Mass loss</b>	<b>ml</b>
<b>Effective heat of combustion</b>	<b>EHC</b>
<b>Total heat evolved</b>	<b>tot. Heat</b>

##### 3.1.2 Thermogravimetry

Thermogravimetry (TG) was carried out by means of a Perkin Elmer TGS-2 Thermogravimetric Analyzer, with platinum pans at a scanning rate of 20°K min<sup>-1</sup>, in air, with an air flow rate of 30 ml min<sup>-1</sup>. Thermogravimetry curves are reported as mass loss as a function of increasing temperature.

### 3.2 MATERIALS TESTED

The polymeric materials to be evaluated in this research programme are:

**Polypropylene, Polyethylene, Polystyrene**, compounded with different classes of flame retardants.

The results presented in this first stage involve polypropylene only, compounded with the flame retardants shown in Table 1. The materials used for the different mixtures are described below:

**Polypropylene (PP)** was Moplen FLF20, from Himont.

**Lignin** was obtained as a residue of cellulose complex degradation of a sample prepared by means of wood steam explosion [13]. The dioxane soluble portion (ca. 67%) had an intrinsic viscosity of 0.05 dl g<sup>-1</sup>, at 25°C in the same solvent and a number-average molecular weight of 1850 g mol<sup>-1</sup>, measured with a vapour pressure osmometer (Perkin Elmer Hitachi model 115) [14].

**Triglycidyl isocyanurate (TGI)** was Araldite PT 810, from Ciba Geigy, which is a trifunctional crystalline compound with a melting point of 100°C.

**Boric Acid** (Fluka, 99%), **Ammonium Phosphate Monobasic** (Carlo Erba, 98%) and **Melamine** (Fluka, 99%) were reagent grade additives, employed without further purification.

<i>FLAME RETARDANTS</i>	<i>% or Molar Ratio</i>	<i>SYMBOL</i>
LIGNIN + TGI	50:50	TLI
MELAMINE + TGI	1:1 M	TME
AMMONIUM ACID PHOSPHATE + LIGNIN	50:50	LFO
LIGNIN	100	LIP
AMMONIUM ACID PHOSPHATE + TGI	1:1 M	TFO
TGI + BORIC ACID	1:2 M	TBP

Table 1. Description of the six materials tested

Each additive was mixed with PP, at a ratio of 80% PP and 20% additive. The selected compound was prepared by using a ball mill. The sample size used for the



cone calorimeter tests is 100 x 100 mm<sup>2</sup>, by 6 mm thick. The specimens were prepared by hot pressing at 40 atm and 210°C.

#### 4. RESULTS AND DISCUSSION

Tests have been carried out on sets of five samples of polypropylene containing flame retardants; the total number of samples used was, thus, 35 samples.

Figure 1 shows the RHR values, as a function of time, for each additive system, compared with those of pure PP.

Figure 1 shows that the flame retardants cause:

- an increase in the total burn time
- a reduction in time to ignition, as compared with that of pure PP
- a great reduction (about 50%) in the peak RHR.

It can also be noticed that the PP + TME system exhibits different behaviour from that of the other materials [15].

Figure 1a reports the RHR curves, versus time, for four different materials. Figure 2 reports the mass loss values measured during combustion, as a function of time. The mass loss trend is the same as that for RHR:

- the longer the combustion progresses, the less mass is lost.
- the longer the combustion time, the larger the amount of char formed by the end of combustion.

Figure 3 shows the effective heat of combustion as a function of time.

Table 2 reports the results obtained from the different assessment parameters already been partially outlined in Figures 1-3. This table also shows the value of the fire performance index (FPI), which is the ratio between time to ignition time ( $t_{ign.}$ ) and the peak rate of heat release (RHR max), giving useful details about the fire reaction of the different materials with reference to the degree of fire hazard [16].

Figure 4 shows a classification of values of FPI with reference to the chemical nature of the additive used as flame retardant. It is possible to notice here a different behaviour of PPTME which has a lower value of FPI than does pure PP [15].

Symbol	Ignit. Time	End Time	RHR (max)	EHC (max)	Total Heat	Final Mass	FPI
	s	s	kW/m <sup>2</sup>	MJ/kg	kJ	%	s m <sup>2</sup> /kW
PP	80	485	990	72,4	1388	0,4	0,08
PP + LIP	45	745	332	70,7	1542	6,0	0,14
PP + TBP	36	550	499	56,0	1518	5,6	0,07
PP + TFO	57	985	327	70,1	1299	11,2	0,17
PP + LFO	41	615	360	64,1	1437	10,7	0,11
PP + TLI	54	625	426	73,4	1632	5,8	0,13
PP + TME	53	460	889	60,9	1588	7,2	0,06

**Tab. 2** Results for the different materials in the cone calorimeter tests.

Figure 5 presents the thermogravimetric curves used to compare the performance of pure PP in air, with that of the compounds containing additives: PPLIP, PPLFO, PPTLI, PPTFO. These mass/temperature curves show that all the compounds containing additives degrade at lower temperatures than does pure PP, producing, in addition, a significant amount of char [14-17]. It is not possible to provide further useful information by comparing the different kinds of additives with pure PP. Table 3 reports the values of temperature at which 5% of the initial mass of the materials has been lost and the percentage of char produced at a temperature of 400°C.

	THERMAL STABILITY		CHAR YIELD	
	% Weight	°C	% Weight	°C
PP + LFO	95	274	21	400
PP + TFO	95	266	11	400
PP + TLI	95	271	8	400
PP + TME	95	275	8	400
PP + LIP	95	286	6	400
PP	95	296	0,5	400

**Table 3.** Results for the different materials by thermogravimetry

In a similar way, Figure 6 shows mass loss values as a function of time, obtained by using the cone calorimeter test. It is possible to point out the qualitative contribution provided by the flame retardants to pure PP.

## 5. CONCLUSIONS

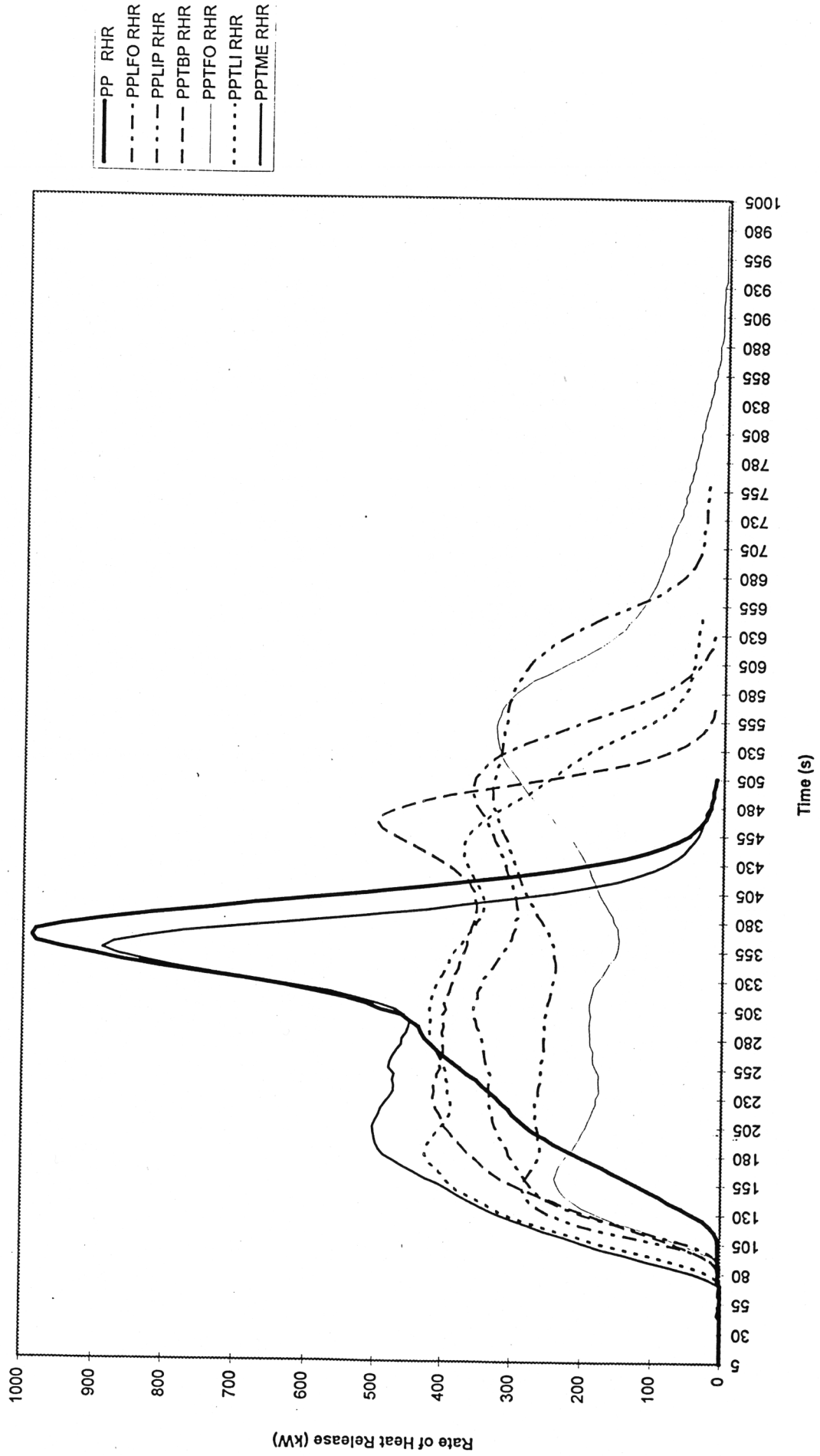
During this first part of the study the difficulty inherent in assessing real fire behaviour of the tested materials, due to the restricted fire scenarios employed, was noted. Nevertheless, the use of the cone calorimeter allowed improvements in the knowledge of how test procedures can be used to understand the effects of additives on the characteristic fire behaviour of the materials into which they are added. The results of the thermogravimetric analysis experiments were compared based only on the different patterns of mass loss as a function of temperature (thermogravimetry) and time (cone calorimetry). The assessment of char production showed a uniform trend in both analyses. Once completed, this study will permit the achievement of all the objectives set out during the initial phase of this research programme.

## 6. REFERENCES

1. Pearce, E.P., Khanna, Y.P. and Raucher, D., Thermal Characterization of Polymeric Materials, chapt. 8, ed. E.A. Turi, Academic Press Inc., 1981.
2. Babrauskas, V. and Peacock, R., Heat Release Rate: The Single Most Important Variable in Fire Hazard, *Fire Safety Journal* 18, 255-272 (1992).
3. Babrauskas, V., Comparative Rates of Heat Release from Five Different Types of Test Apparatuses, *J. Fire Sciences* 4, 148-159 (1986).
4. Babrauskas, V., Development of the Cone Calorimeter Bench Scale Heat Release Apparatus Based on Oxygen Consumption, *Fire and Materials*, 8, 81-95 (1984).
5. Babrauskas, V., Smoke Measurement Results from the Cone Calorimeter, pp. 420-434, *Proc. of the 8th Joint Panel Meeting UJNR Panel on Fire Research and Safety*, Building Research Institute, Tsukuba, Japan (1985).
6. Parker, W.J. , Calculation of the Heat Release Rate by Oxygen Consumption for Various Application, *J. Fire Sciences* 2, 380-395 (1984).

7. Huggett, C. Estimation of the Rate of Heat Release by Means of Oxygen Consumption, *J. Fire and Flammability*, 12, 61-65 (1980).
8. Tsuchiya, Y., Methods of Determining Heat Release Rate: State of the Art, *Fire Safety Journal* 5, 49-57 (1979).
9. Tordella, J.P. and Twilley, W.H., Development of a Calorimeter for Simultaneously Measuring Heat Release and Mass Loss Rates (NBSIR 832708) (U.S) Nat. Bur. Stand., Gaithersburg, MD (1983).
10. Janssens, M., Measuring Rate of Heat Release by Oxygen Consumption, *Fire Technology* 27 (August) 234-49 (1991).
11. Babrauskas, V., "Heat Release in Fires", chapt. 2, ed. Babrauskas, V. and Grayson, S.J., pp. 7-29, Elsevier Applied Science, London, UK (1992).
12. Hirschler, M.M. Heat Release from Plastic Materials, in Heat Release in Fires, chapt. 12a, ed. Babrauskas, V. and Grayson, S.J. pp. 375-422, Elsevier Applied Science, London, UK (1992), and references therein.
13. Glasser, W.G. and Kelley, S.S., *Encycl. Polym. Sci. Eng.*, 2nd edn, Vol. 8, p. 795, J. Wiley and Sons, New York, NY, 1986.
14. De Chirico, A., Audisio, G., Provasoli, F., Focher, B. and Grossi, B., *Angew. Makrom. Chem.* (in the press).
15. Costa, L., Camino, G., Bertelli, G. and Borsini, G., *Fire and Materials* (in the press).
16. Hirschler, M.M., How to measure smoke obscuration in a manner relevant to fire hazard assessment: Use of heat release calorimetry test equipment, *J. Fire Sciences*, 9, 183-222 (1991).
17. De Chirico, A., Audisio, G., Provasoli, F. and Armanini, M., *Journal Thermal Anal.*, 38 2759 (1992).

Fig.1 Rate of Heat Release of Polypropylene mixed with different additives



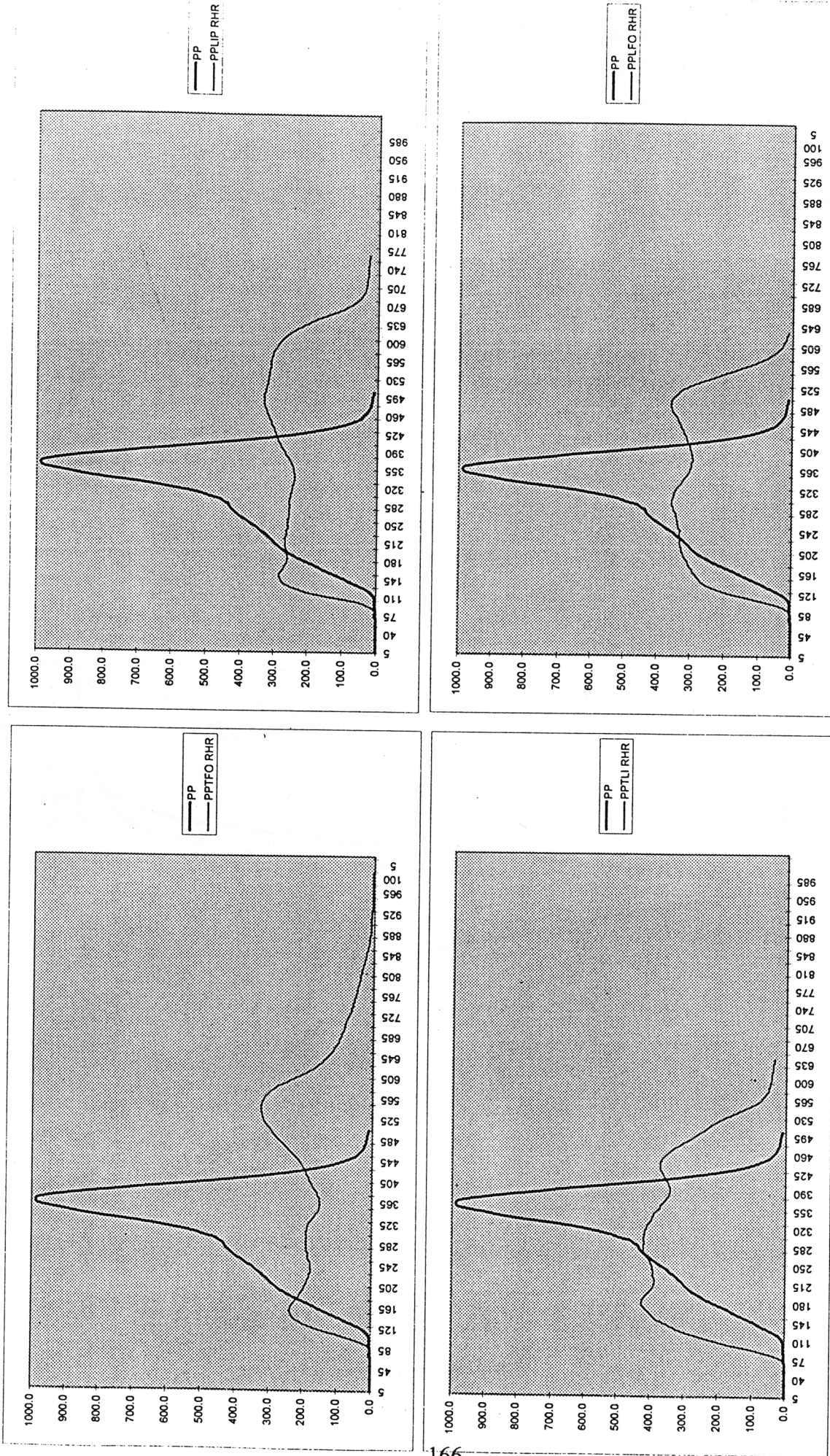


Fig. 1a Rate of Heat Release of four added PPs in comparison with pure PP

Fig.2 Mass loss of Polypropylene mixed with different additives

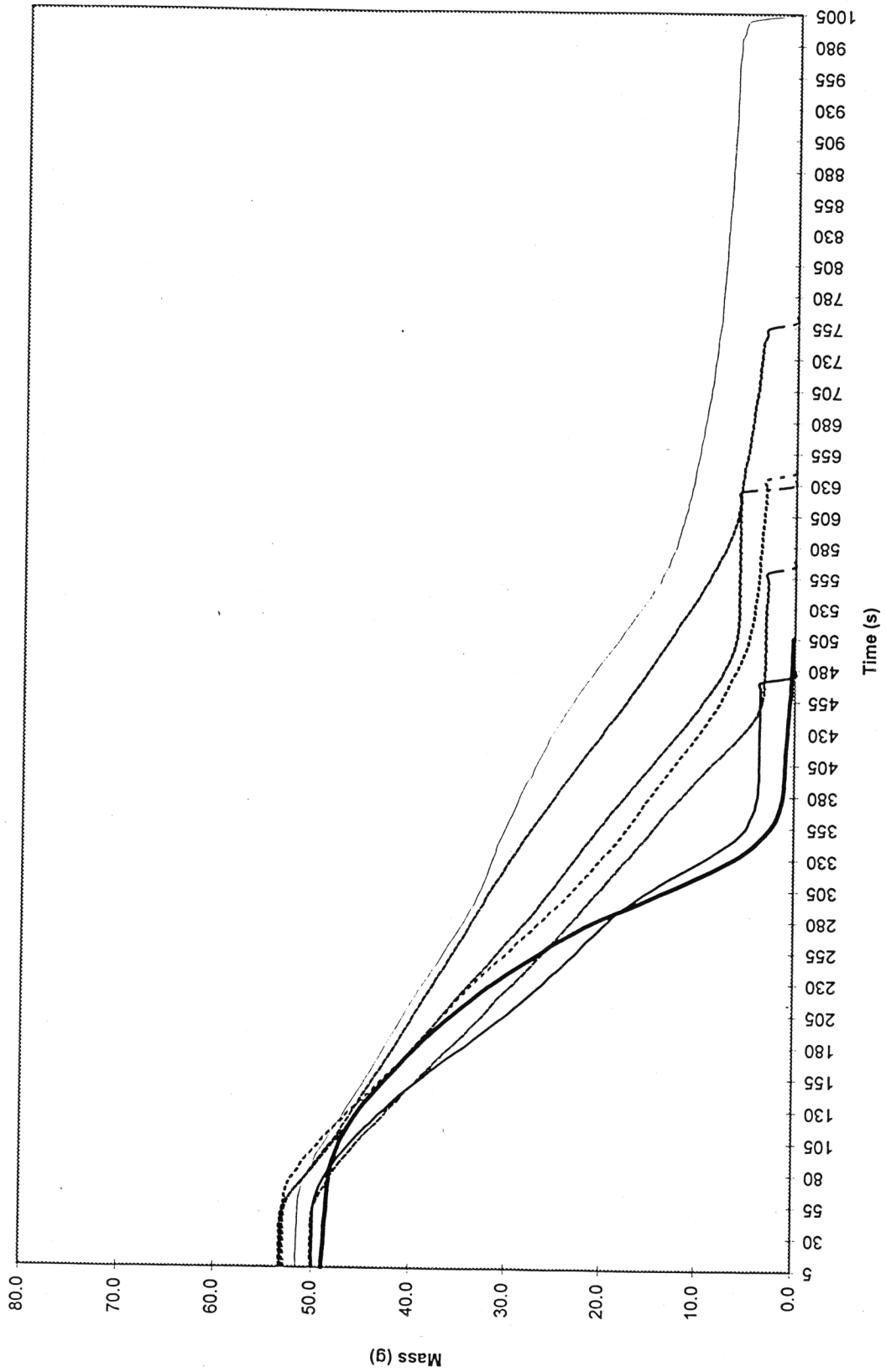
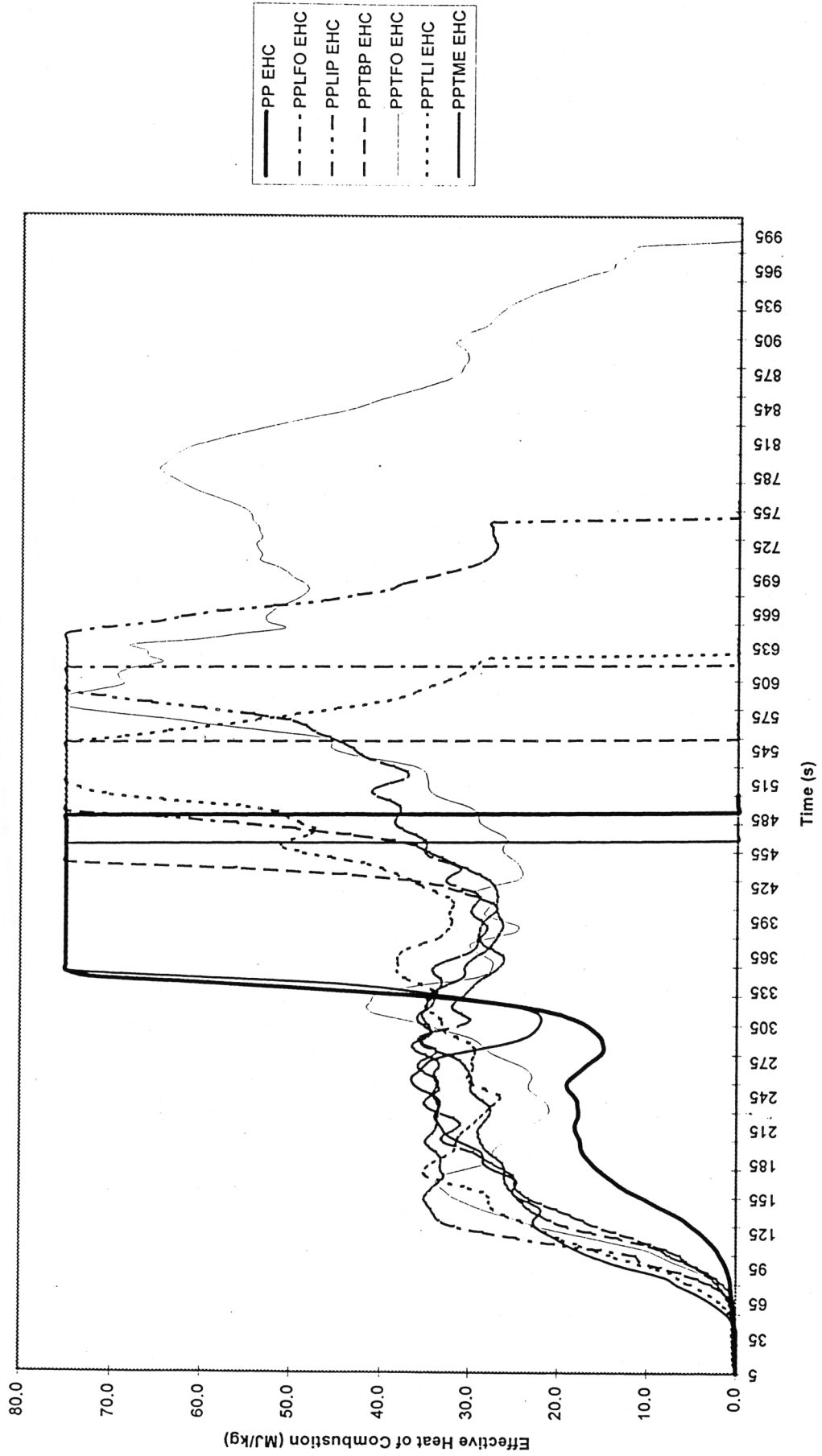


Fig.3 Effective Heat of Combustion of Polypropylene mixed with different additives





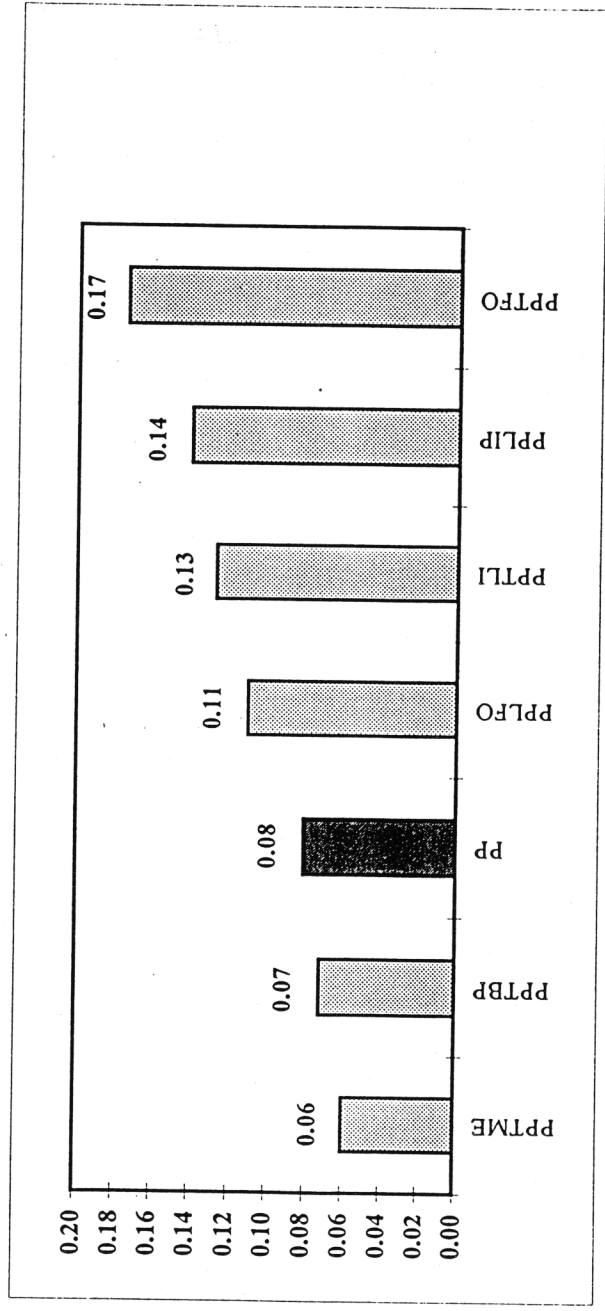


Fig.4 Fire Performance INDEX of Polypropylene mixed with different additives

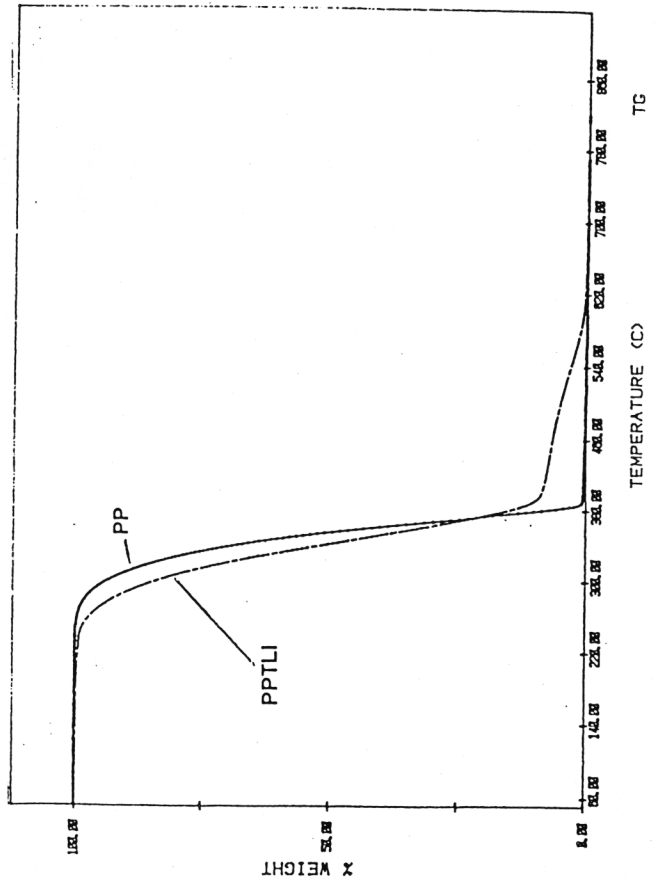
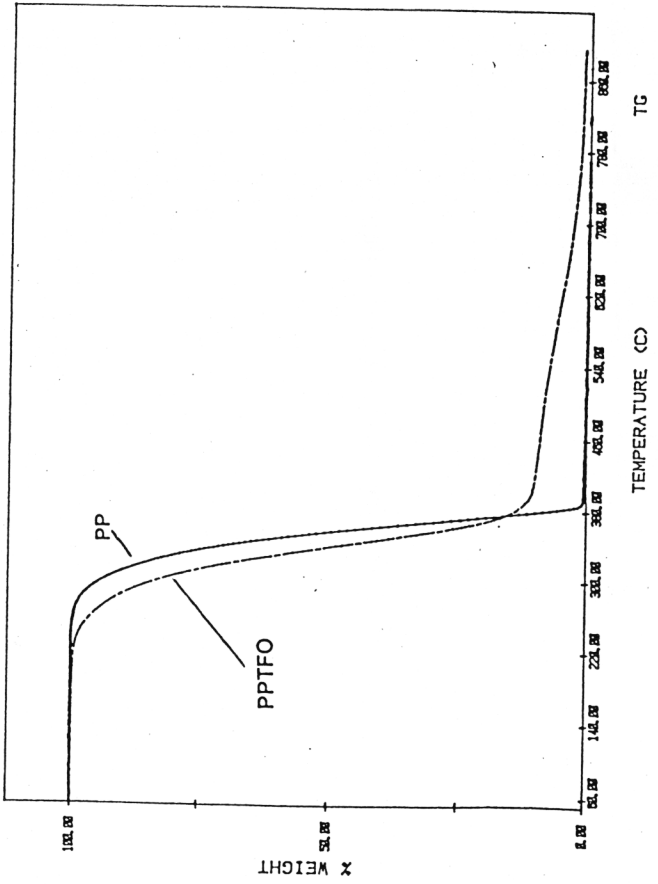
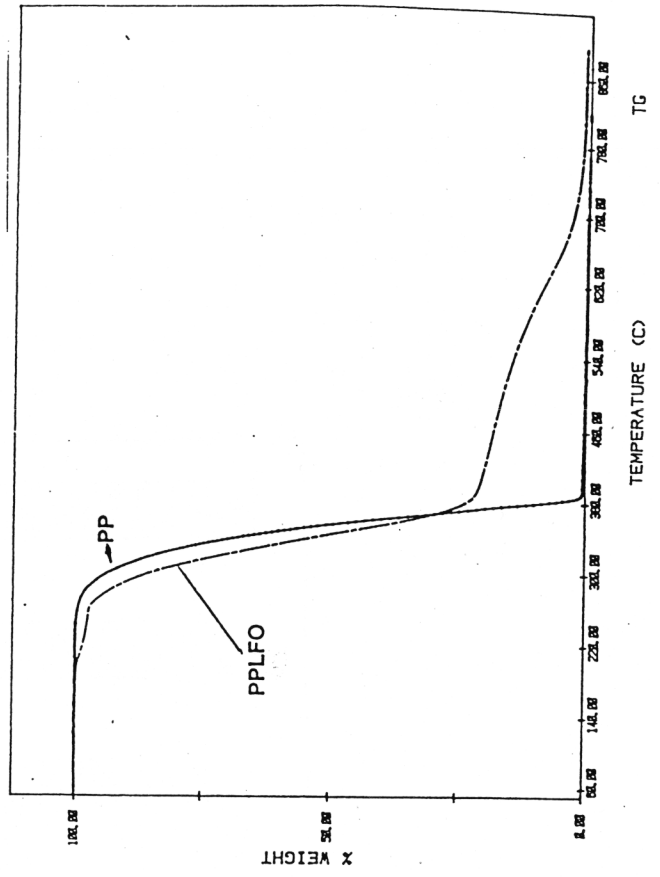
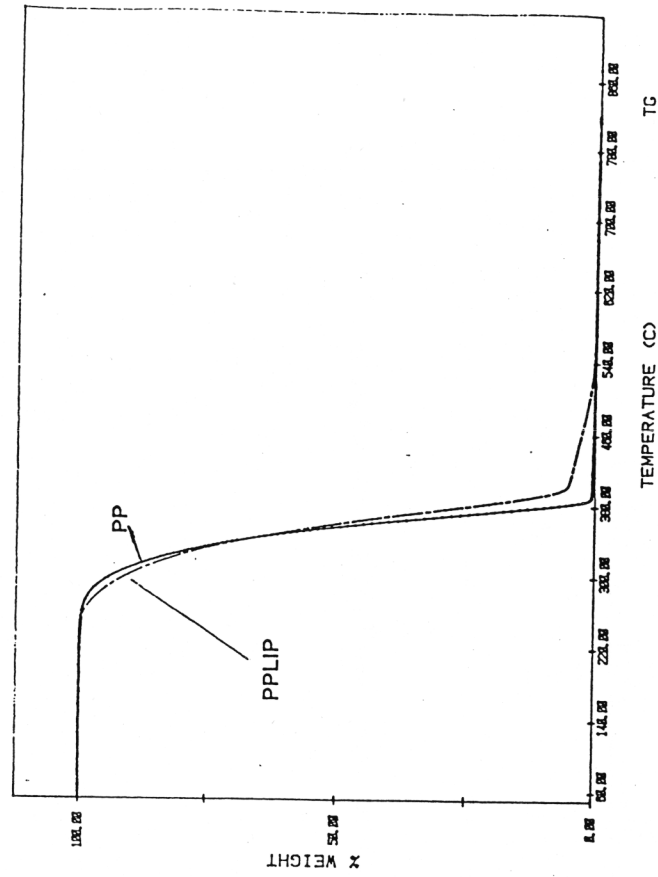


Fig.5 Comparison of thermogravimetric curves in air as a function of the temperature for pure PP with four added PPs

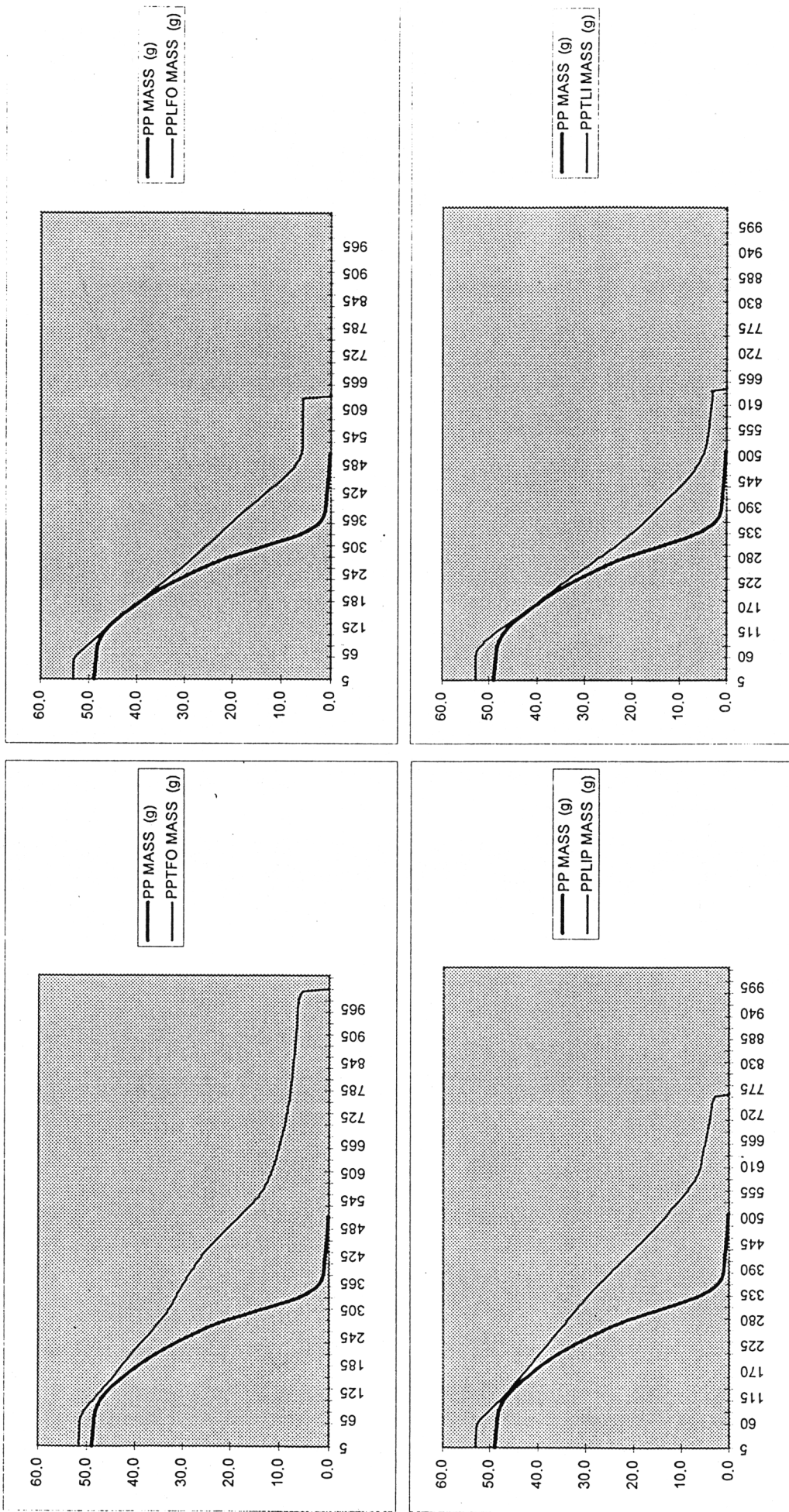


Fig.6 Mass loss as a function of time analyzed with Cone Calorimeter for different products

SYNTHESIS OF HIGH PERFORMANCE PHOSPHINE  
OXIDE THERMOPLASTICS

J.E. McGrath

Virginia Polytech Institute and State University

# IMPLEMENTATION OF HEAT RELEASE MEASUREMENTS AS A REGULATORY REQUIREMENT FOR COMMERCIAL AIRCRAFT MATERIALS

Constantine P. Sarkos  
Richard G. Hill  
Richard M. Johnson

Fire Safety Section  
AAR-422, Bldg. 201A  
FAA Technical Center  
Atlantic City Airport, NJ 08405

## **Abstract**

The Federal Aviation Administration (FAA) requires heat release rate fire test criteria based on the Ohio State University (OSU) Rate of Heat Release Apparatus for large surface area cabin materials in commercial airliners. Full-scale aircraft fire tests were employed to demonstrate the relevancy of heat release performance criteria to postcrash aircraft fire survivability and to select pass/fail test values. During the implementation of the FAA/OSU test requirement a relatively large disparity was observed in data obtained from a number of laboratories operating the OSU apparatus to a supposedly identical American Society of Testing and Materials (ASTM) Standard. This initial lack of test reproducibility was a major concern to both the FAA and aviation industry. Improved reproducibility was achieved and demonstrated by a number of modifications agreed to by the participating laboratories in the design, calibration and operation of the OSU apparatus. Because of its regulatory application modifications were incorporated that promote test simplicity, minimal test cost and time, compatibility with aircraft materials as well as between laboratory reproducibility. Radiant heater calibration problems associated with the use of Gardon gage calorimeters manufactured by different companies is the main emphasis at this time.

## **Background**

Aircraft fire safety addresses both in-flight and postcrash fire conditions. Of the two areas of concern the postcrash fire receives the greatest attention because practically all aircraft fire fatalities are caused by crash fires. Therefore, fire test criteria for aircraft cabin materials, required by the FAA, were derived from postcrash fire considerations.

The development of FAA cabin material fire test criteria was based on full-scale fire tests. The predominance of burning jet fuel in past aircraft accidents dictated that the full-scale tests employ a jet fuel fire as an ignition source. Care was taken to select a scenario in which the combustion hazards from cabin materials controlled survivability, i.e., the jet fuel fire primarily acted as an ignition source. Combustion hazards generated by the jet fuel fire did not affect occupant survival. The scenario employed consisted of an external fuel fire

adjacent to a fuselage opening (simulated rupture or door) in an otherwise intact fuselage. A door opening located a good distance from the fire origin factored in the effect of emergency exits. There were no wind conditions to draw the fuel fire flames and combustion products into the cabin (Reference 1).

Under the conditions described above, full-scale tests show that cabin materials adjacent to the fire opening are subjected to intense thermal radiation and ignite after a short period of time. The fire, however, does not spread readily although the combustion products form a hot smoke layer at the ceiling which spreads throughout the cabin. Much of the lower part of the cabin below the smoke layer, remains at or near ambient conditions. Survival is possible throughout most of the cabin until the onset flashover. After flashover occupant survival becomes highly unlikely (Reference 2). Because cabin flashover is clearly the critical factor affecting postcrash fire survivability, FAA material fire test criteria were developed and chosen to provide significant delay in the onset of cabin flashover (References 3 and 4).

Two major upgrades in cabin material fire performance have been implemented by the FAA over the past 10 years. The first regulation required a retrofit of all seats in the U.S. fleet with fire blocking layers (Reference 5). Fire blockers are thermally resistant underlayers that encase the urethane foam cushion, reducing the foam's burning rate when subjected to an intense fire. Full-scale tests have shown that fire blocking layers can delay the onset of flashover by as much as 60 seconds during a postcrash fire (Reference 3).

The second regulation required the installation of low heat release materials for large surface area applications, including sidewalls, ceiling, stowage bins and partitions, in aircraft manufactured after August 20, 1990 (Reference 6). The test method specified by FAA was the OSU Rate of Heat Release Apparatus. Again, full-scale tests demonstrated that low heat release panels served to further delay the onset of flashover, providing additional enhancement in postcrash fire survivability. This paper will review the FAA development and implementation of the heat release rate test criteria.

### **Derivation of Heat Release Rate Test Criteria**

It should be noted that flashover is a phenomena that generally occurs when fire in an enclosure generates heat at some critical rate that is affected by heat transfer and ventilation. Flashover to a large degree is caused by the heat release rate of burning interior materials. Thus, a rate of heat release test methodology will tend to yield the contribution of a given material to the flashover event. Also, selection of interior materials on the basis of minimizing heat release rate serves to implicitly reduce the cabin smoke and toxic gases hazards since it is the flashover event that generates hazardous quantities of combustion products.

Several studies were conducted to correlate the performance of composite panels in a heat release test device and under realistic cabin fire conditions. Initially, a variety of laboratory flammability tests were evaluated in terms of panel performance with results in a 1/4-scale cabin model (Reference 7). The OSU apparatus exhibited the best correlation with model

fire test results. Although probably any of the available heat release rate tests would serve to yield the flashover potential of various panel materials, the OSU apparatus was selected specifically for further evaluation and development. The decision to select the OSU apparatus was based on the above correlation study as well as recommendations of an FAA advisory committee, the availability of the OSU apparatus with the airframe manufacturers and its standardization by ASTM. A second study corroborated the earlier good correlation results in that it established an inverse relationship between heat release measurements in the OSU apparatus and time-to-flashover of a series of composite panels evaluated under full-scale postcrash fire conditions (Reference 4).

The second correlation study involved tests of five composite panel constructions under a scenario consisting of an external fuel fire adjacent to an open door. To realistically evaluate panel performance, the flat panel test specimens were installed in a typical configuration that included sidewalls, stowage bins, ceiling and partitions. In this arrangement, other factors such as ease of ignition and flame spread rate for the panels, as well as the contribution of fire blocked seats and carpet, were allowed to come into play. The results of these tests are shown in Figure 1 as an FED history plot. The graph indicates a wide range in behavior for the five types of panels. The phenolic/Kevlar and epoxy/fiberglass panels displayed the earliest flashovers, whereas the phenolic/fiberglass panel delayed flashover by about 3 minutes. Moreover, there was a monotonic, inverse relationship between heat release measured by the OSU apparatus and time to flashover. Also, the data indicate that small changes in heat release by materials may result in large changes in the time to cabin flashover.

The actual criteria for material selection were driven by the level of benefits evidenced by full-scale testing. The phenolic/fiberglass panel tested well under virtually any test condition (Reference 4), and this construction was achievable by state-of-the-art manufacturing processes. Thus, the phenolic/fiberglass panel was used as a benchmark for selection of the performance criteria for OSU testing of panel materials. A pass/fail criteria of  $65 \text{ kw-min/m}^2$  for a 2-minute total heat release was selected to embrace the performance of the phenolic/fiberglass panel. An additional criterion of  $65 \text{ kw/m}^2$  for peak heat release rate was included to eliminate usage of those materials that burn rapidly but produce small quantities of heat because of their low weight.

The pass/fail criteria arrived at by FAA was based on a thermopile measurement of heat release rate as described in the ASTM OSU apparatus standard. An earlier study by FAA had evaluated the thermopile and oxygen depletion methods for measurement of heat release. It was determined that there was an excellent correlation between the two heat release measurement methods. Figure 2 compares thermopile and oxygen depletion peak heat release rate readings taken simultaneously in the FAA OSU apparatus for a series of materials, including aircraft honeycomb composite panels, test panels and thermoplastics. The correlation coefficient of the best fit straight line relating the 2 measurements was an excellent 0.992. Moreover, the ranking of materials was also excellent (0.978 correlation coefficient); the rank order of the 17 materials tested did not deviate by more than 2 places. Similarly, the total heat release showed an excellent correlation between the thermopile and

oxygen depletion measurements, (Reference 8); Based on this excellent correlation, and the higher cost and complexity of the oxygen depletion measurement, including perceived difficulties in measuring small differential oxygen concentrations for low heat release materials, FAA concluded that the thermopile method was more appropriate as a regulatory tool.

### **Improvement of Heat Release Test Reproducibility**

The reproducibility of data between different laboratories is always an important issue, particularly when a material fire test method is employed as a regulatory requirement. This concern was more pronounced for the proposed FAA heat release standard because the large majority of aircraft materials failed the recommended pass/fail criteria. The rule was, in effect, a technology driver since the aircraft industry was required to develop new, fire-safe material designs to gain compliance with the proposed standard. Before undertaking such a massive and expensive effort, it was necessary to attain a high degree of confidence in the consistency of the data driving the redesign of aircraft materials.

In order to evaluate the reproducibility of the OSU apparatus, FAA, Boeing and Douglas exchanged OSU data on a series of aircraft materials. Each laboratory was asked to operate its OSU apparatus in accordance with ASTM E-906, "Standard Test Method for Heat and Visible Smoke Release Rates for Materials and Products". An analysis of the OSU data generated by the 3 laboratories showed inconsistent test results. It became apparent that there were major differences in the design, calibration and operation of the OSU chambers, and that the laboratories were not adhering strictly to the ASTM standard. This was determined by a detailed examination of the design and operation of each chamber by all of the operators. Every difference in test design/procedure and each perceived problem area was carefully studied and an improvement was developed and agreed upon. Table 1 contains a description of the major changes made to the OSU apparatus for aircraft material testing and what improvement was accomplished by each change.

It should be noted that the improved standardization of the OSU apparatus outlined in Table 1 was accomplished over a period of time, encompassing three round robin test programs by FAA and industry. Some of the modifications evolved from in-depth examinations. For example, temperature measured across the exhaust stack outlet in each OSU chamber, employing a 12-thermocouple grid, exhibited wide variations, including hot spots in corners. A new thermocouple employing a thermopile in the center and each of the four corners of the exhaust outlet better matched the detailed temperature mapping than the 3-thermocouple thermopile specified by ASTM. Thereupon, the new thermocouple employing 5 thermopile was adopted. Other changes were dictated by the burning behavior of aircraft materials, such as a redesign of the pilot burners, including a lower burner spark ignitor, 15-hole upper burner, and the use of a premixed air/gas mixture. It was determined that some flame retardant aircraft materials consistently extinguished the old pilot burner flames, invalidating the test results. The new pilot burners flames are more difficult to extinguish and reignite automatically when extinguished.



The net effect of the changes described in Table 1 was to significantly improve the reproducibility of the OSU apparatus, as evidenced by three round robins conducted by FAA, Boeing, Douglas and OSU. The average relative standard deviation (percent) for total (2-minute) heat release for the first, second and third round robins was 25.7, 14.1 and 7.7, respectively. Also, the average relative standard deviation for peak heat release rate for the third round robin was 7.8 percent. Figure 3 presents the total heat release results for the third round robin for the 13 composite materials tested. Although some materials exhibited greater variability than others, the overall results are reasonably good.

A subsequent and more challenging appraisal of the reproducibility of the FAA-modified OSU apparatus was conducted during an international round robin involving 15 laboratories in the United States, Europe and Canada. Each laboratory was asked to abide by the improved OSU standard (reference 9), although adherence was not confirmed as in the earlier round robins. Thirteen aircraft materials were tested, including honeycomb composite panels, a decorated aluminum sheet, fiberglass laminates and thermoplastic sheets. The average relative standard deviation for total heat release and peak heat release rate was 13.1 and 12.6 percent, respectively. Although the overall relative standard deviation was about 5 percentage points higher than the final round robin in the United States, the reproducibility of the FAA-modified OSU apparatus exceeds most standardized fire test methods.

The reproducibility of fire tests is obviously a function of the composition of the materials being tested. Aircraft materials are not monolithic but are usually complex composites or laminates. During fire test exposure aircraft material assemblies may char, delaminate, melt or shrink, depending on the method of constraint, introducing sources of variability. Figures 4 and 5 compare the reproducibility of the best (material C) and worst (material G) materials, in terms of 2-minute heat release, during the international round robin. In terms of reproducibility, the best material was a 4-ply phenolic fiberglass laminate and the worst material was a crushed core phenolic composite. In terms of FAA pass/fail criteria, it is interesting that all 15 laboratories were consistent in that the fiberglass laminate failed and the crushed core composite passed the FAA standard.

### Current Concern

An ongoing concern is the Gardon gage calorimeter used to set the specified incident radiant heat flux to the exposed sample. The calorimeter probably represents the greatest remaining source of test variability for the OSU apparatus and other fire test methods as well. Since the heat release varies as the incident heat flux, deviation in the incident flux setting to a level above or below the specified value,  $3.5 \text{ Watts/cm}^2$ , has a corresponding effect on the rate of heat release. Calibration of the Gardon gage is a major concern. Figure 6 shows the variation in the calibration of a particular Gardon gage by different laboratories, including FAA, NIST and three calorimeter manufacturers. This variability is expected somewhat because the method of calibration used by each laboratory may be different. What is more surprising is that the calibration changed when repeated by a laboratory at a later point in

time (e.g., Laboratory A, FAA). The apparent heat flux in the OSU chamber corresponding to each calibration curve is shown in Figure 7. It was assumed that the FAA OSU chamber provided the correct calibration environment (FAA calibration is traceable to NIST). Most laboratory calibrations would appear to indicate higher heat flux levels, except for Laboratory C which was rather low.

Currently, FAA is evaluating two potential calibration problem areas - the high absorbance paint used to coat the calorimeter surface and the temperature of the calorimeter cooling water. A calorimeter has been received from each of the Gardon gage manufacturers. FAA will coat the surface with a specific paint (Krylon 1602). The aim is to eliminate any variability caused by different coatings or methods of application. The calorimeter will then be returned to the laboratory for calibration, specifying a cooling water temperature of 130°F in order to minimize any surface condensation problems. If these factors do not provide an acceptable improvement in calorimeter calibration, FAA may be forced to consider specifying the calibration procedure and/or calorimeter design.

### References

1. Sarkos, C. P., Hill, R. G., and Howell, W. D., "The Development and Application of a Full-Scale Wide-Body Test Article to Study the Behavior of Interior Materials During a Postcrash Fuel Fire," AGARD Lecture Series No. 123 on Aircraft Fire Safety, AGARD-LS-123, June 1982.
2. Sarkos, C. P., "Application of Full-Scale Fire Tests to Characterize and Improve the Aircraft Postcrash Fire Environment," International Colloquium on Advances in Combustion Toxicology, April 13-15, 1995, Civil Aeromedical Institute, Oklahoma City, Oklahoma.
3. Sarkos, C. P., and Hill, R. G., "Effectiveness of Seat Cushion Blocking Layer Materials Against Cabin Fires," Society of Automotive Engineers Technical Paper No. 821,484, presented at Aerospace Congress and Exposition, October 25-28, 1982.
4. Hill, R. G., Eklund, T. I., and Sarkos, C.P., "Aircraft Interior Panel Test Criteria Derived from Full-Scale Fire Tests," Federal Aviation Administration, Report DOT/FAA/CT-85/23, September 1985.
5. Flammability Requirements for Aircraft Seat Cushions; Final Rule, DOT/FAA, Federal Register, Vol. 49, No. 209, p. 43, 188, October 26, 1984.
6. Improved Flammability Standards for Materials Used in the Interiors of Transport Category Airplane Cabins; Final Rule, DOT/FAA, Federal Register, Vol, 53, No. 165, p. 32, 564, August 25, 1988.

7. Sarkos, C. P., Filipczak, R. A., and Abramowitz, A., "Preliminary Evaluation of an Improved Flammability Test Method for Aircraft Materials," Federal Aviation Administration, Report DOT/FAA/CT-84/22, December 1984.
8. Hill, R. G. and Fitzgerald, L. T., "Interlaboratory Comparison of Heat Release Data from Aircraft Panels," Federal Aviation Administration, Report DOT/FAA/CT-TN86/3, March 1986.
9. Aircraft Material Fire Test Handbook, Federal Aviation Administration, Report DOT/FAA/CT-89/15, September 1990.

<u>Item</u>	<u>Description</u>	<u>Improvement</u>
<u>Sample Exposure</u>		
1. Diamond-shaped mask	Specify thickness/materials	Sample heat exposure uniformity
2. Sample holder	Specify thickness/material Eliminate backing board Vertical wires (2)	Reduce variability/heat sink effect Realistic sample exposure Minimize variability caused by delamination/melting
3. Pilot burners	Spark igniter for lower burner Multi-hole upper burner Pre mixed flames	Eliminate extinguishment of pilot flames by flame retardants, invalidating results
4. Chamber air flow	Specify orifice flow rate measurement Disallow separate air supplies for chamber/pyramidal sections	More consistent air flow patterns throughout apparatus
<u>Measurements</u>		
5. Thermopile	Specify 5 thermocouple grid in exhaust stack	Reduce errors associated with temperature differences measured across exhaust stack outlet
6. Thermocouples	Specify gauge, bead size, unsheathed length	More accurate heat release profile, especially at peak
7. Thermal inertia compensator	Eliminate	Eliminate potential source of error (shown to have negligible effect on data)
8. Holding chamber	Hinged door	Stabilize thermopile baseline
9. Blank sample burn correction	Eliminate	Reproducibility improved without blank correction
<u>Calibration</u>		
10. Calorimeter insertion	Specify mounting of calorimeter on sample holder	Precision and standardization of radiant heat source setting
11. Heat release calibration	Define methane flow rate step profiles	Accuracy of heat release measurement Reduce calibration time

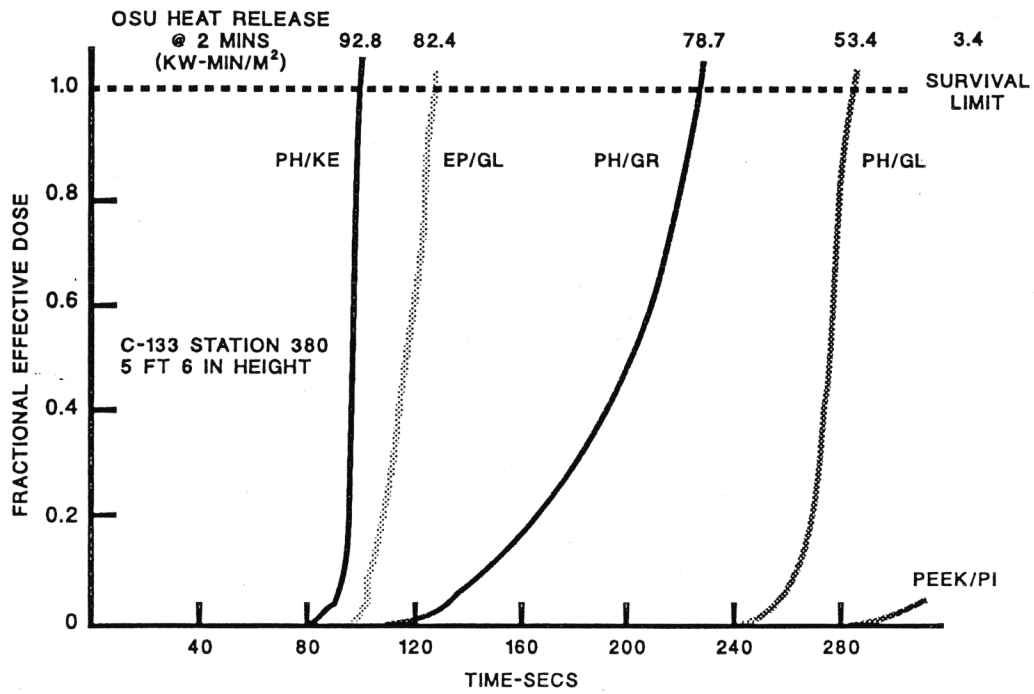


FIGURE 1. EFFECT OF COMPOSITE PANEL DESIGN ON FRACTIONAL EFFECTIVE DOSE & OSU HEAT RELEASE

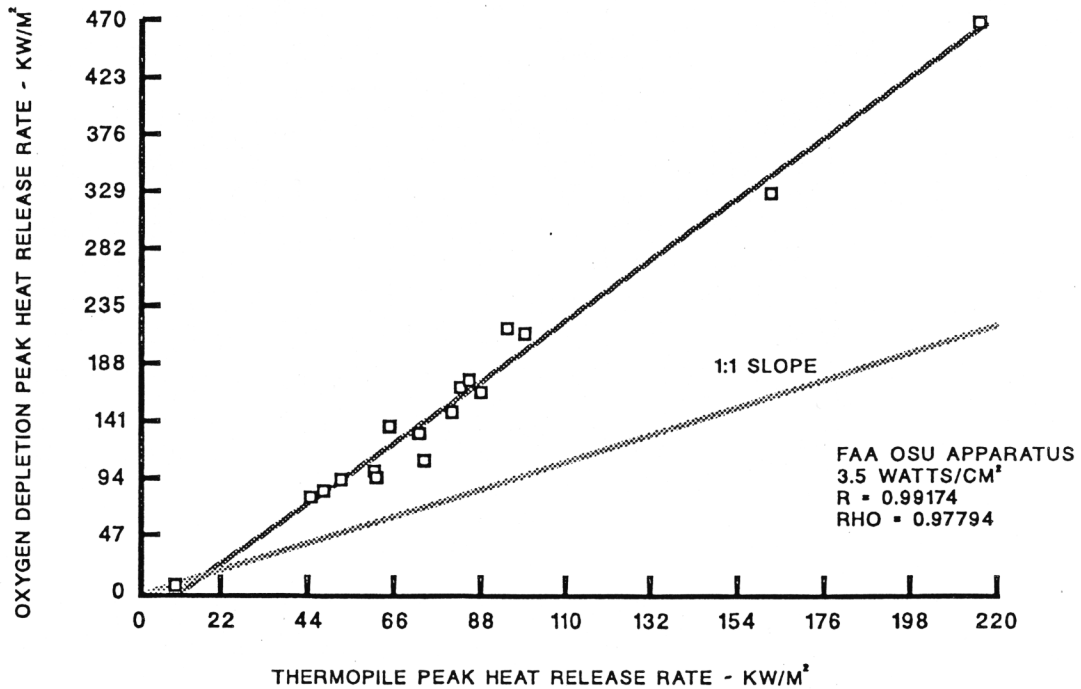


FIGURE 2. BEST FIT RELATIONSHIP BETWEEN O<sub>2</sub> AND THERMOPILE PEAK HEAT RELEASE MEASUREMENT

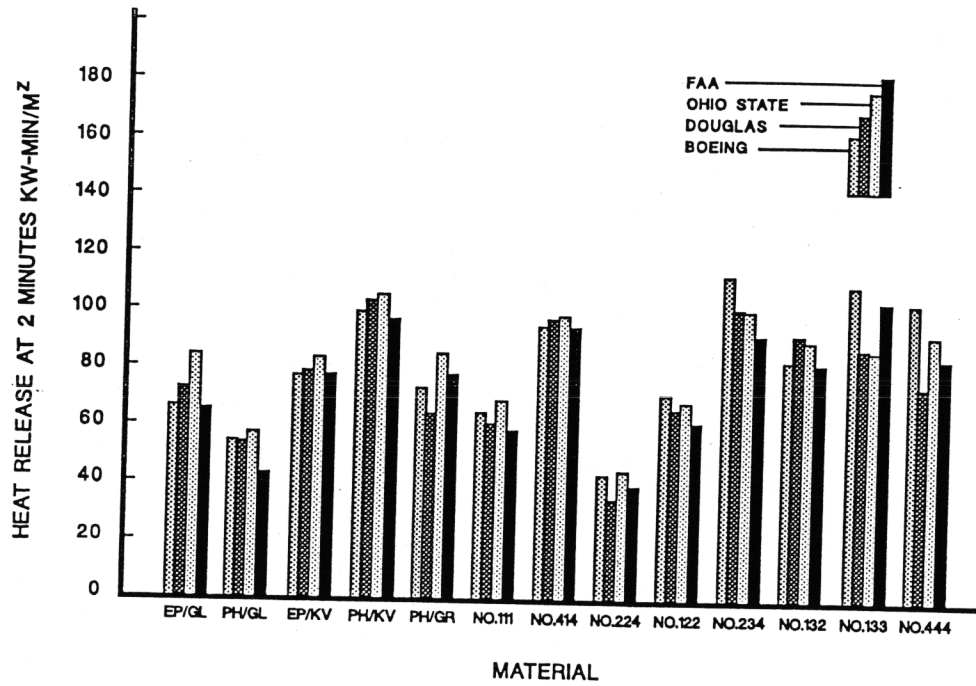


FIGURE 3. REPRODUCIBILITY OF OSU HEAT RELEASE APPARATUS - FAA/AIA THIRD ROUND ROBIN

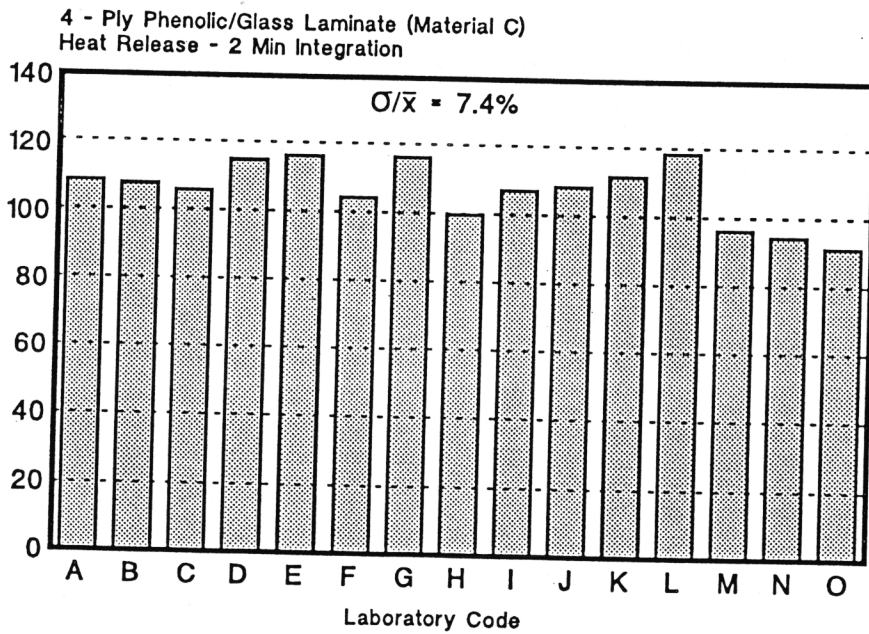


FIGURE 4. REPRODUCIBILITY OF OSU HEAT RELEASE APPARATUS-FAA INTERNATIONAL ROUND ROBIN (BEST MATERIAL)

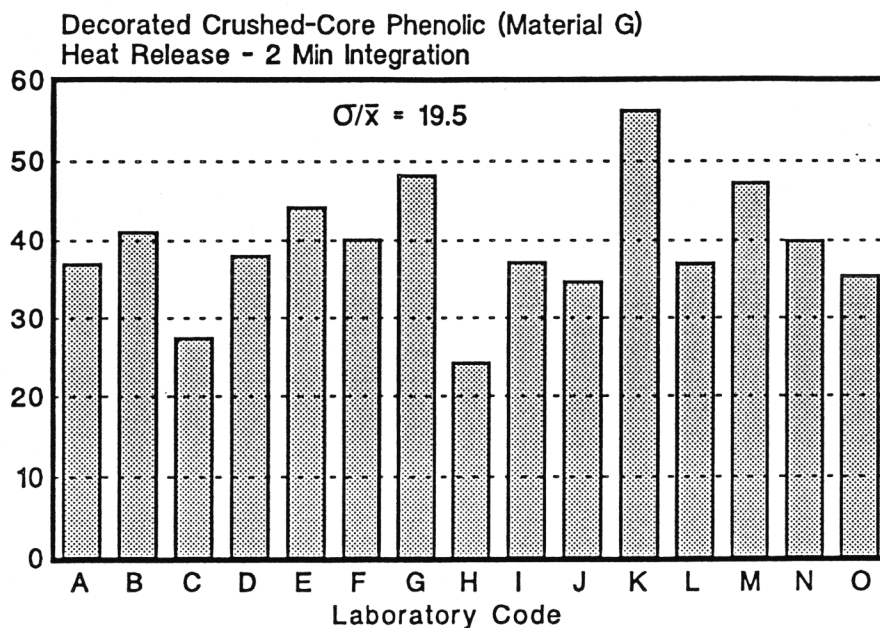


FIGURE 5. REPRODUCIBILITY OF OSU HEAT RELEASE APPARATUS-FAA INTERNATIONAL ROUND ROBIN (WORST MATERIAL)

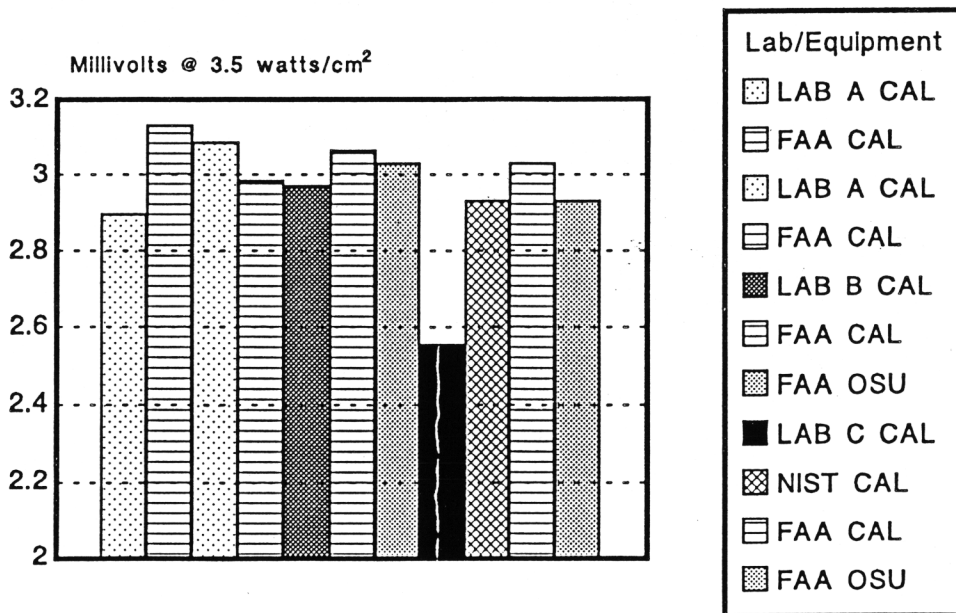


FIGURE 6. CALIBRATION OF A GARDON GAUGE CALORIMETER BY DIFFERENT LABORATORIES

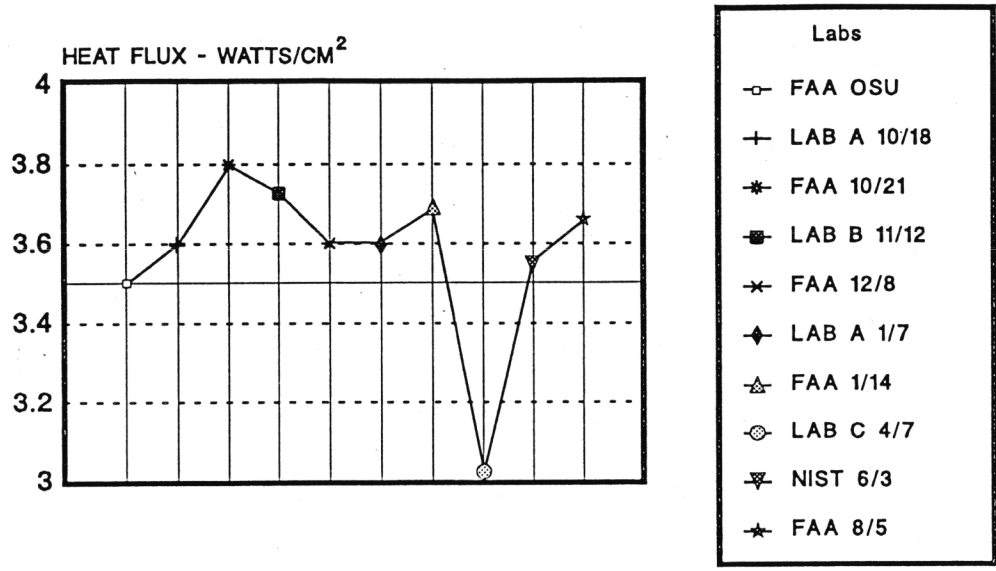


FIGURE 7. APPARENT INCIDENT HEAT FLUX TO SAMPLE IN OSU CHAMBER USING DIFFERENT CALIBRATION CURVES



# Combustion Behavior of Phenolic Triazine Resin

F. E. Arnold Jr., J. Rodriguez-Arnold A. Granville, R. Lyon  
Fire Research Branch, AAR-423  
Federal Aviation Administration Technical Center  
Atlantic City, NJ 08405

## Abstract

Phenolic triazine (PT-30) is a fire resistant, high char yield engineering thermoset which cures by an addition cyclotrimerization reaction to a polycyanurate network of oxygen linked triazine rings connected through the phenol novolac backbone. Phenolic triazine produces no volatiles upon curing, possesses a high glass transition temperature (in excess of 400°C) and a high decomposition temperature which provides thermal stability comparable to bismaleimides. The present study utilizes thermogravimetric analysis to obtain pyrolysis kinetic parameters which are related to flaming combustion. Bomb and oxygen consumption calorimetry were used to investigate the heat release, heat release rates, and the combustion efficiency of the cyanurate network.

## Introduction

Cyanate ester resins possess attractive features which include toughness, high glass transition temperatures, low dielectric constants and excellent adhesive properties. The mechanical properties of cyanate ester resins fall between epoxies and bismaleimides, thus applications in composite systems are presently being explored. A trifunctional cyanate ester based on the phenol-novolac system is presently undergoing commercialization (Primaset PT-30). PT-30 (Figure 1) is a fire resistant, high char yield thermoset which cures by an addition trimerization reaction resulting in a thermally stable cyanurate network of oxygen-linked triazine rings connected through the phenol novolac backbone. Phenol novolac based cyanate ester resins have considerably better fire resistance compared to bisphenol E based dicyanates because of enhanced thermal stability resulting from the ortho and meta methylene bridges between phenyl rings of the phenolic resin compared to the carbon-dimethyl group which is present in the bisphenol E derivatives. The principal advantages of cyanate ester resins, whether difunctional or trifunctional, are the absence of volatiles during cure and potentially low cost.

The thermal stability of PT-30 approaches that of high temperature polyimide thermosets based on an overall activation energy [1]. As a result of possessing a high thermal stability, moderate price, a low toxicity profile, phenol novolac based cyanate esters are being considered as replacements for phenol formaldehyde systems in aircraft cabin interiors. Figure 2 [2] illustrates the OSU heat release results for composite panels constructed from PT-30 and traditional

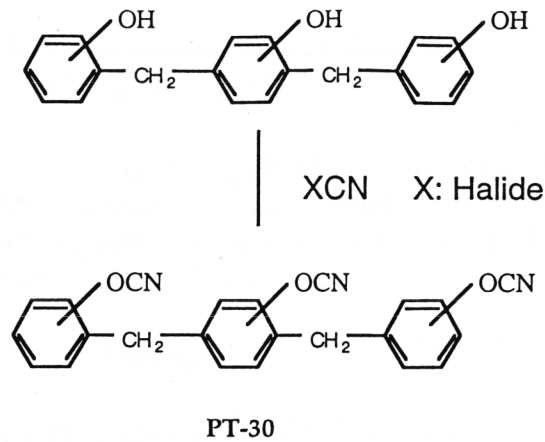


Figure 1. Chemical structure of Primaset PT-30

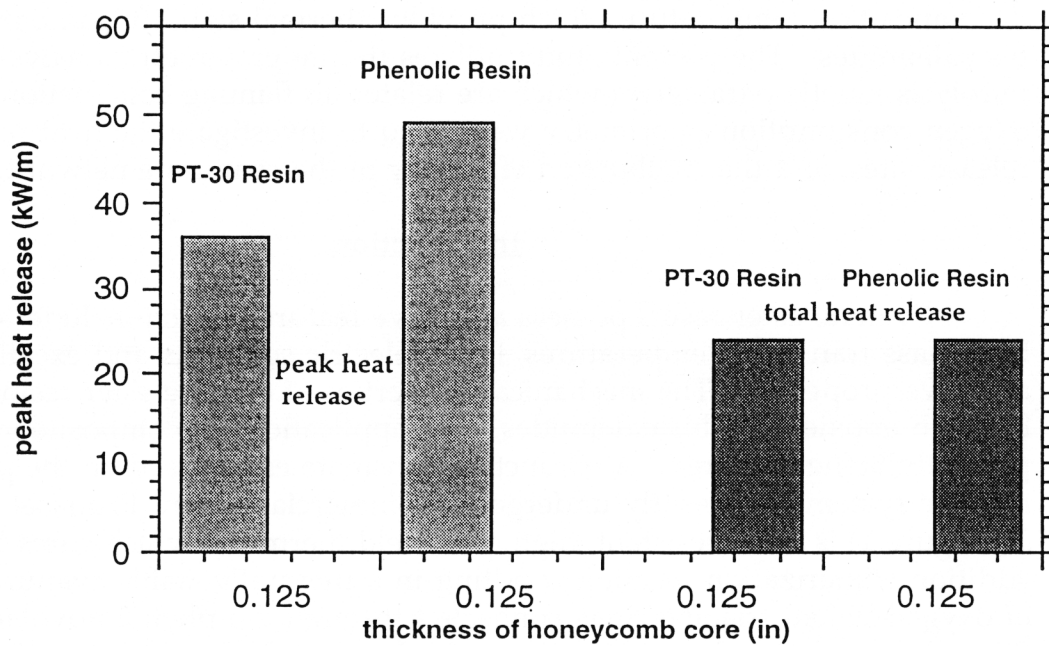


Figure 2. OSU heat release results for composite panels

phenolic resins. One notes that there is a reduction from 49 kW/m to 37 kW/m when the phenolic resin is replaced by the triazine system. Oxygen consumption calorimetry was employed to investigate the total heat release as well as the heat release rates at different heat fluxes. Bomb calorimetry will be combined with oxygen consumption calorimetry to calculate the combustion efficiency of the network.

## Materials

The phenolic triazine resin used in this study is a product commercially produced by Allied-Signal (Primaset PT-30) by cyanation of a phenol novolac trimer. At room temperature PT-30 is a highly viscous liquid ( $\eta = 7000$  Poise) which cures thermally with or without the addition of transition metal catalyst. Thermal curing of PT-30 results in the cyclotrimerization of the cyanate ester groups resulting in a polycyanurate network (Figure 3).

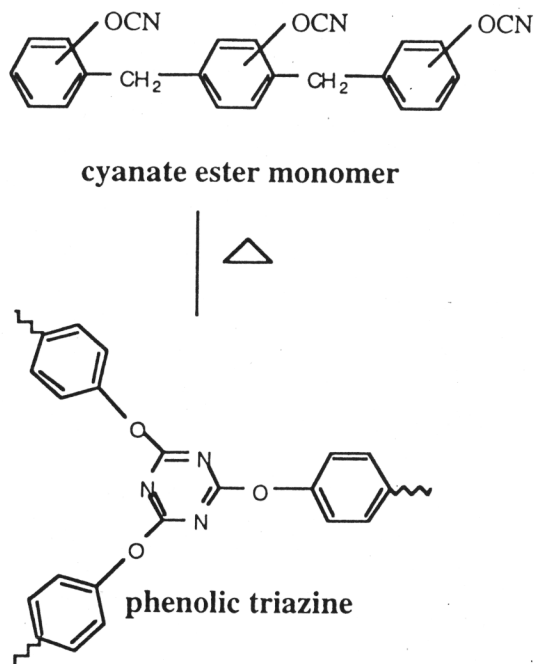


Figure 3. Addition cyclotrimerization reaction of Primaset PT-30

## Methods

**Sample Preparation:** Samples for LOI, bomb calorimetry and cone calorimetry were cured according to cure cycles determined from differential scanning calorimetry. Complete conversion of the cyanate ester group was confirmed from Fourier transform infrared spectroscopy.

**Thermal Stability:** Thermogravimetric analysis (Perking Elmer TGA-7) was used to study the thermal degradation of PT-30. Isothermal experiments were carried out in air and nitrogen. Each sample was cured at 250°C prior to analysis. The weight loss with respect to time was recorded at different isothermal

temperatures and the Arrhenius parameters were extracted according to Equations 1-4.

$$\frac{d\alpha}{dt} = k(T)f(\alpha) \quad (1)$$

$$k(T) = A \exp\left(\frac{-E_a}{RT}\right) \quad (2)$$

$$\int_0^\alpha \frac{d\alpha}{f(\alpha)} = k(T) \int_0^t dt \quad (3)$$

$$g(\alpha) = k(T)t = A \exp\left(\frac{-E_a}{RT}\right)t \quad (4)$$

From a plot of  $\ln(t)$  versus reciprocal temperature at constant conversion one can extract the kinetic parameters.

**Oxygen Index:** Flammability of the fully cured system was determined using the limiting oxygen index test as per ASTM D 2863-87.

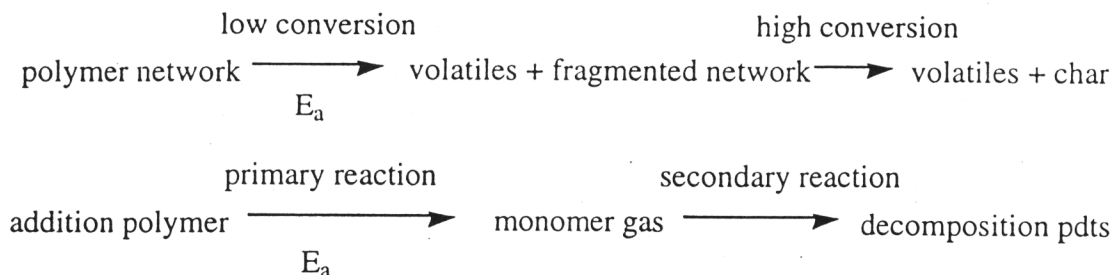
**Chemical Heat of Combustion:** The chemical heat of combustion of the cured resin and char residue was measured in an oxygen bomb calorimeter (Parr Model 1341) according to ASTM D-3286.

**Heat Release Rate:** Total heat release rate was measured on the NIST cone calorimeter according to ASTM E-1354.

### Results and Discussion

**Thermal stability:** Nonisothermal TGA measurements show that PT-30 starts to decompose at around 450°C. This indicates superior thermal stability compared to phenolic based resins which typically decompose at temperatures of less than 350°C. Under a nitrogen atmosphere char yields exceeding 60% were observed which is comparable to char yields observed by flaming combustion in the cone calorimetry. From Equation 4 an activation energy of 290 kJ/mol was calculated under anaerobic conditions. Other high performance polymers such as poly(benzobisoxazole) and high temperature polyimides exhibit activation energies of 280 kJ/mol and 300 kJ/mol under similar experimental conditions compared with PT-30. Therefore the thermal stability deduced from the activation energy alone is comparable to other high performance polymers. At low conversions I. e. initial generation of volatiles, the activation energy

corresponds to the amount of energy required to break the weakest link in the network. For an addition polymer such as PMMA the activation energy is equal to the heat of gasification. PMMA decomposes by a depolymerization mechanism resulting in a conversion from a linear polymer to volatilized monomer as illustrated in the schematic below. The decomposition products from the pyrolysis of PMMA are simply the decomposition products of the monomer used to synthesize the polymer.



A thermoset such as PT-30 decomposes via a random chain scission resulting in the initial generation of a small percentage of volatiles and a fragmented network. For the cyanurate network the activation energy for pyrolysis is proportional to the heat of gasification. A system with a large activation energy such as PT-30 will result in a lower mass loss rate during a fire.

**Flammability:** The oxygen index value of 31 was determined for the phenolic triazine resin. This value is compared to other high temperature thermoset and thermoplastic resins in Table 1. The flammability of the cured network is comparable to bismaleimides and phenolic resins.

**Chemical Heat of Combustion:** Oxygen bomb calorimetry was used to determine the calorific value of PT-30. The calorimeter was calibrated with standard benzoic acid as per ASTM D-3286. The neat resin was found to have a heat of combustion of 29.305 kJ/g. The value calculated for the cyanurate network is similar to epoxies and polyesters [3]. Samples were prepared for cone calorimetry and the resulting char was subjected to bomb calorimetry. A value of 29.880 kJ/g was calculated for the char. The heat of combustion from the resulting char will be used in conjunction with the effective heat of combustion measured by cone calorimetry to characterize the combustion efficiency of the cyanurate network.

**Heat Release Rate:** The rate of heat release is one of the most important parameters for characterizing a fire in an enclosed area. Oxygen consumption calorimetry takes advantage of the relationship between chemical heat release and the heat of complete combustion per gram of oxygen consumed in a fire (Equation 5).

Thermoset Polymer	LOI (%)
Bismaleimide	35
Phenolic resin	32
PT-30	31
Epoxy resin	25
Thermoplastic Polymer	LOI (%)
Polyetherimide	47
Polyethersulfone	37
Polycarbonate	34
Polysulfone	30

**Table 1. Comparison of the LOI for PT-30 with other commercial thermoplastics and thermosets**

$$\dot{Q}_{\text{chem}} = \Delta H_0 \dot{C} \quad (5)$$

where:  $\Delta H_0$  = heat of complete combustion per gram of oxygen consumed

$\dot{C}$  = mass consumption rate of oxygen

The mass consumption rate of oxygen during a fire is proportional to the overall mass loss rate according to Equation 6.

$$\dot{C} = c_0 \dot{m} \quad (6)$$

where:  $c_0$  = the mass of oxygen consumed per unit mass of fuel (g/g)

Since it is impractical to measure the mass flow rate of oxygen being consumed in a fire the cone calorimeter measures the volumetric flow rate. The mass consumption rate of oxygen is described in Equation 7.

$$\dot{C} = \frac{f_0 \dot{V} \rho_0}{A} = f_0 \dot{W} \left[ \frac{\rho_0}{\rho_g A} \right] \quad (7)$$

where:  $f_0$  = volume fraction of oxygen

$\dot{V}$  = total volumetric flow rate of the  
fire products air mixture

$\dot{W}$  = total mass flow rate of the fire  
products air mixture

$\rho_g$  = density of the hot fire products  
air mixture

Figure 4 illustrates the phenomenology of a cone test for PT-30. The nominal rate of heat release is plotted as a function of time. The two peaks observed are the result of the oxygen consumed when burning the surface exposed to the heater and the back surface exposed to the sample mount. The nominal heat release is equivalent to the area under the curve. A value of 130 kW/m<sup>2</sup> was calculated which is a reasonable value for a high char yielding system. Table 2 lists the relevant heat release values for PT-30 at the three heat fluxes investigated. One notes that the effective heat of combustion levels off for incident heat fluxes of over 50 kW/m<sup>2</sup>.

The surface temperature of a burning solid is close to the rate dependent decomposition temperature. The heat of gasification is an important parameter since it is the materials intrinsic parameter determining the amount of fuel which is available to burn. From a plot of the peak mass loss rate verses the irradiance from the heaters the heat of gasification may be extracted (Figure 5), according to Equation 8. The slope from Figure 5 will be the inverse of the heat of gasification.

$$\dot{m}_a = \frac{\dot{Q}_{net}}{L_g} = \frac{\dot{Q}_{ext}}{L_g} + \frac{\dot{Q}_{flame} - \dot{Q}_{loss}}{L_g} \quad (8)$$

where:  $L_g$  = heat of gasification

$\dot{Q}_{ext}$  = heat flux from the external heater

$\dot{Q}_{flame}$  = heat flux from flame

A value of 1.95 kJ/g was calculated for PT-30. For an ideal fire resisted material the heat of gasification should be maximized in order to reduce the overall mass loss rate thus reducing the amount of fuel which is available to burn.

By combining bomb and oxygen consumption calorimetry we can calculate the combustion efficiency of the system. The combustion efficiency is another

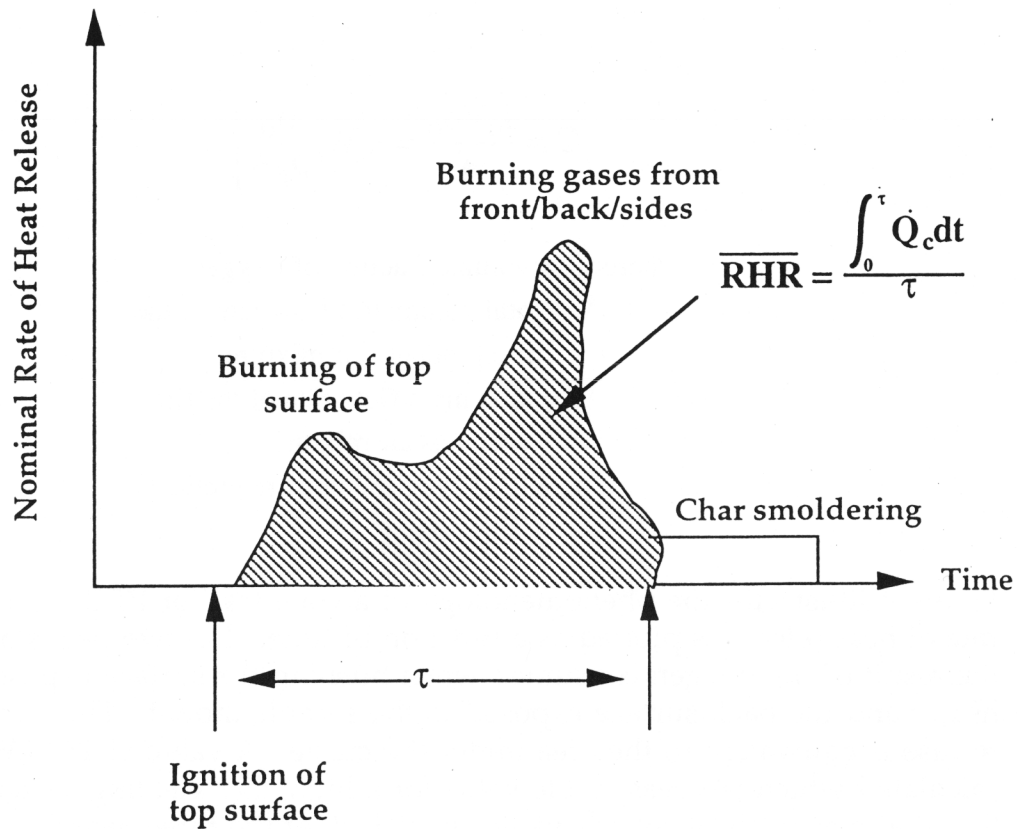


Figure 4. Nominal rate of heat release verses time

Heat flux kW/m <sup>2</sup>	Char yield	Ignition time (sec)	Total heat release (MJ/m <sup>2</sup> )	Peak mass loss rate (g/m <sup>2</sup> -sec)	$\Delta H_{eff}$ (kJ/g)
35	0.6105	152	48.64	30.90	15.02
50	0.5862	89	72.18	37.10	18.58
75	0.5494	39	72.60	51.00	18.74

Table 2. Cone results for Primaset PT-30



important governing material characteristic when considering polymer flammability. Bomb calorimetry was performed on the neat resin as well as on the remaining char from a cone test. From a mass balance analysis the total heat of combustion is equal to the fractional heat of combustion of the char in addition to the fractional heat of combustion of the generated fuel.

$$\Delta H_{\text{total}}^0 = Y_c \Delta H_{\text{char}}^0 + (1 - Y_c) \Delta H_{\text{gas}}^0 \quad (9)$$

$$\Delta H_{\text{gas}}^0 = \frac{\Delta H_{\text{total}}^0 - Y_c \Delta H_{\text{char}}^0}{(1 - Y_c)} \quad (10)$$

where  $Y_c$  = char yield

The combustion efficiency (X) is defined as the ratio of the effective heat of combustion measured by cone calorimetry to the heat of combustion of the pyrolyzed portion of the sample according to Equation 11.

$$X = \frac{\Delta H_{\text{eff}}}{\Delta H_{\text{gas}}^0} \quad (11)$$

Figure 6 shows the combustion efficiency as a function of incident heat flux. The combustion efficiency levels off at a value of 0.65 at incident heat fluxes of greater than 50 kW/m<sup>2</sup>. According to Tewarson [4] the combustion efficiency for synthetic polymers follows the following order:

Aliphatic > Aliphatic/Aromatic > Aromatic > Highly halogenated

PT-30 with an average combustion efficiency of 0.61 fits into the scheme shown above for a highly aromatic system.

### Conclusions

Phenolic triazine is a fire resistant high char yielding material. The thermal stability was quantified by an activation energy and was found to be comparable to other high performance polymers. The activation energy for pyrolysis was calculated at low degrees of conversion and this value is proportional but not equal to the heat of gasification for the network. The heat of gasification was extracted from cone calorimetry. A value of 1.95 kJ/g corresponds well when compared to other high char yielding polymers. A combustion efficiency of 0.61 was calculated utilizing bomb and cone calorimetry. PT-30 has a combustion efficiency similar to polystyrene but the overall char yield measured by TGA exceeds 60%.

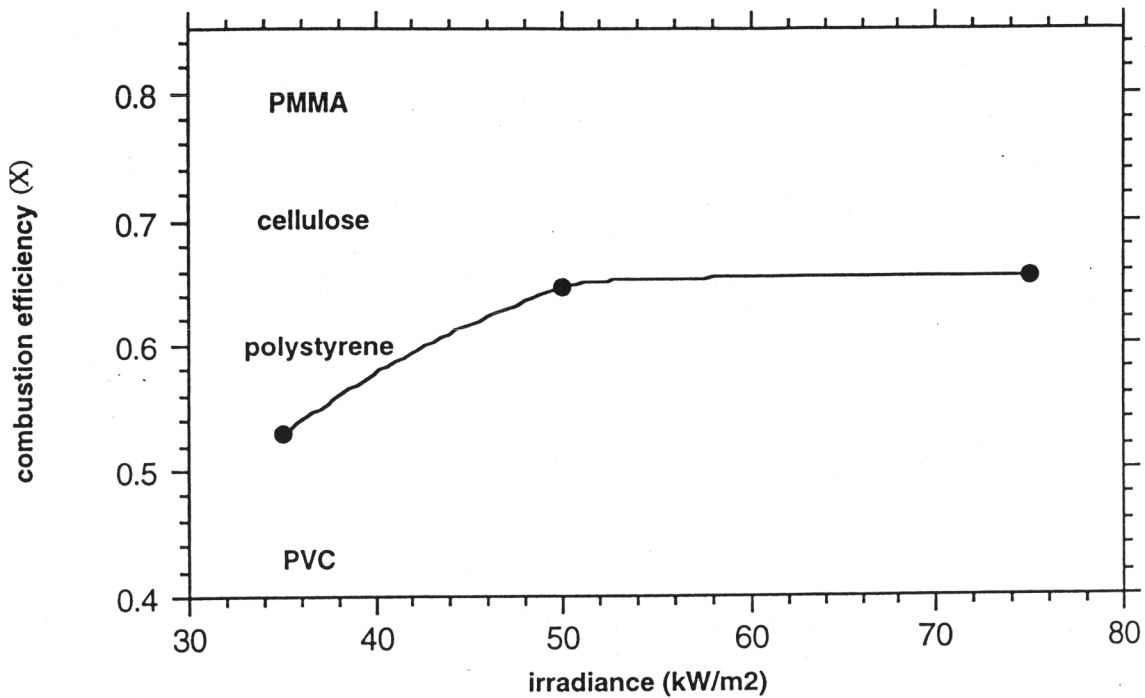


Figure 6. Combustion efficiency as a function of incident heat flux

### References

- (1) J. Rodriguez-Arnold, F. E. Arnold Jr., R. E. Lyon, "Thermochimica Acta", submitted.
- (2) F. E. Arnold Jr., J. Rodriguez-Arnold, A. Granville, S. Das, R. E. Lyon, "Fire Retardant Chemical Association", Williamsburg, VA October, 1994.
- (3) A. Tewarson, "Generation of Heat and Fire Products", FMRC Technical Report, May, 1995.
- (4) D. Drysdale, An Introduction to Fire Dynamics, Wiley and Sons, New York, 1985.

# MATERIAL PROPERTIES AND HEAT RELEASE RATE OF POLYMERS

Richard E. Lyon  
Fire Research Section, AAR-423  
Federal Aviation Administration Technical Center  
Atlantic City International Airport, N.J. 08405 USA

## ABSTRACT

Phenomenological equations for solid material burning in combination with pyrolysis kinetics and uncoupled transient heat conduction provide relationships between material properties and the fire response of polymeric materials. The predicted scaling of ignition temperature, time to ignition, heat of gasification, mass loss rate, and heat release rate with thermodynamic, kinetic, and transport properties is in reasonable agreement with available data for polymeric solids using this simple approach.

## INTRODUCTION

Heat release rate is considered to be the single most important fire parameter in determining the fire hazard of a material. Unfortunately, no analytic results for heat release rate in terms of chemical or physical properties of materials have been derived to guide chemists in their syntheses of fire resistant polymers. Current material fire models are computational loops in computer-based fire codes. Material parameters required by these computational fire models include at a minimum the chemical heat of complete combustion of the material, a combined heat transport parameter (thermal inertia), and a "decomposition temperature" at which the material becomes a gaseous fuel. In a few sophisticated fire codes two additional pyrolysis kinetic parameters may be required to complete the material model. These material fire models have no physical basis outside of the computational regime and are of little value to material scientists seeking a qualitative understanding of how thermodynamic, kinetic, mechanical, and transport properties of polymeric materials effect their fire response. In order to provide some physical insight into the phenomenology of materials combustion, simple scaling relationships between tailorable material properties and the fire response of polymeric solids are developed and verified in the following sections. It is hoped that these analytic results will help guide the development of totally fire resistant materials for next generation aircraft interiors.

## RATE-DEPENDENT DECOMPOSITION TEMPERATURE OF POLYMERS

The peak mass loss rate (decomposition) temperature for a thermally decomposing polymer is obtained from the appropriate kinetic expression. For the first-order pyrolysis of a polymer with volatile mass,  $m$ , and non-volatile (char) mass,  $m_c$ ,

$$-\frac{dm}{dt} = k(m-m_c) \quad (1)$$

Assuming an Arrhenius rate constant,

$$k = A \exp(-E_d/RT) \quad (2)$$

and a constant heating rate,  $dT/dt = \dot{T}$ , the peak pyrolysis temperature is obtained by setting the time derivative of the mass loss rate in Equation 1 (second time derivative of mass) equal to zero at  $T = T_p^{\max}$ , i.e.,

$$-\dot{m} = k_p \dot{m} + (m - m_c) \dot{k}_p = 0 \quad @ \quad T = T_p^{\max}.$$

The resulting non-dimensionalized equation in terms of  $T_p^{\max}$  is [1]

$$\ln \left[ \frac{E_a}{R T_p^{\max}} \right]^2 + \frac{E_a}{R T_p^{\max}} + \ln \left[ \frac{R \dot{T}}{A E_a} \right] = 0 \quad (3)$$

Solution of Equation 3 for the dimensionless root,  $[E_a/RT_p^{\max}]$  for a particular heating rate,  $\dot{T}$ , gives the temperature at maximum mass loss rate with the use of the Arrhenius parameters,  $A$ ,  $E_a$ . A plot of calculated  $T_p^{\max}$  vs.  $\dot{T}$  for polymethylmethacrylate (PMMA,  $A=10^{12}/s$ ,  $E_a=160$  kJ/mol) is shown in Figure 1.

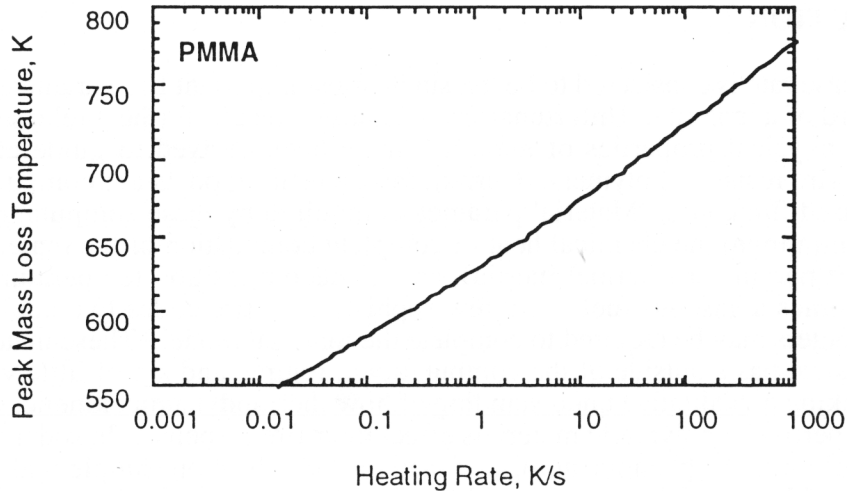


Figure 1. Temperature at peak mass loss rate versus linear heating rate for PMMA according to first-order kinetics.

## IGNITABILITY

The thermal theory of ignition assumes that ignition occurs when the surface temperature of the material reaches its ignition temperature, i.e.,  $t = t_{ign}$ , at  $T_s = T_{ign}$ , at which time and temperature sufficient fuel generation takes place to sustain flaming combustion. Consequently, this ignition temperature is on the order of a thermal decomposition temperature for the material. In the previous section it was shown that the peak decomposition temperature of a polymer has a strong dependence on heating rate in the region 1-100 K/s typically encountered in fire testing.

The surface temperature history for a semi-finite slab with a constant net heat flux to the surface,  $\dot{Q}_{net}$ , is

$$T_s(t) = T_o + 2\dot{Q}_{net} \left[ \frac{t}{\pi \kappa \rho C_p} \right]^{1/2} \quad (4)$$

with  $T_s$  the surface temperature at time  $t$ , and  $T_o$  the initial (ambient) temperature of the material. Rearranging Equation 4 with the assumption that the surface temperature at ignition is the (rate dependent) peak pyrolysis temperature,  $T_s = T_{ign} = T_p^{max}$ , gives for the time to ignition

$$t_{ign} = \pi \kappa \rho C_p \left[ \frac{T_p^{max} - T_o}{2\dot{Q}_{net}} \right]^2 \quad (5)$$

Equation 5 calculates the time to ignition of a thermally thick polymer specimen using the rate (heat flux) dependent peak pyrolysis temperature for a particular  $\dot{Q}_{net}$ . The heating rate at the surface of a thermally thick polymer specimen during radiant heating is not constant, but may be approximated by a single time-average rate of temperature rise,  $\langle dT/dt \rangle$ . The semi-infinite slab result valid up to time,  $\tau = \rho C_p b^2 / 4\kappa$ , for a net heat flux,  $\dot{Q}_{net}$  on the face of a slab of thickness,  $b$ , density,  $\rho$ , thermal conductivity,  $\kappa$ , and heat capacity,  $C_p$ , gives for the time-averaged heating rate [1]

$$\dot{T} = \left\langle \frac{dT}{dt} \right\rangle = \frac{1}{\tau} \int_0^\tau \frac{\dot{Q}_{net}}{\sqrt{\pi \kappa \rho C_p}} \frac{dt}{\sqrt{t}} = \frac{4}{\sqrt{\pi}} \frac{\dot{Q}_{net}}{\rho b C_p} \quad (6)$$

The results of Equations 6 and 3 for poly(methylmethacrylate) (PMMA) exposed to net heat flux levels from 5 to 75 kW/m<sup>2</sup> were substituted into Equation 5 and the results plotted in Figure 2. It is seen that a rate-dependent decomposition temperature correlates the measured time-to-ignition for PMMA over a range of incident heat flux levels [2] using  $A = 10^{12}/s$ ,  $E_a = 160$  kJ/mol [3] for the Arrhenius parameters, and  $\kappa \rho C_p = 6 \times 10^5$  W<sup>2</sup>-s/m<sup>4</sup>-K<sup>2</sup> [4] for the thermal capacitance. At external heat fluxes below about 10 kW/m<sup>2</sup> the semi-infinite slab conduction solution (Equation 4) over predicts the surface temperature (under predicts time-to-temperature) so that a finite-slab calculation which takes into account heat losses from the rear surface at the longer heating times must be used to obtain an accurate surface temperature history. The finite slab calculation (not shown) indicates that below about 8 kW/m<sup>2</sup> incident heat flux the surface temperature of PMMA never reaches the peak decomposition temperature, in general agreement with a measured critical heat flux of about 10 kW/m<sup>2</sup> [5].

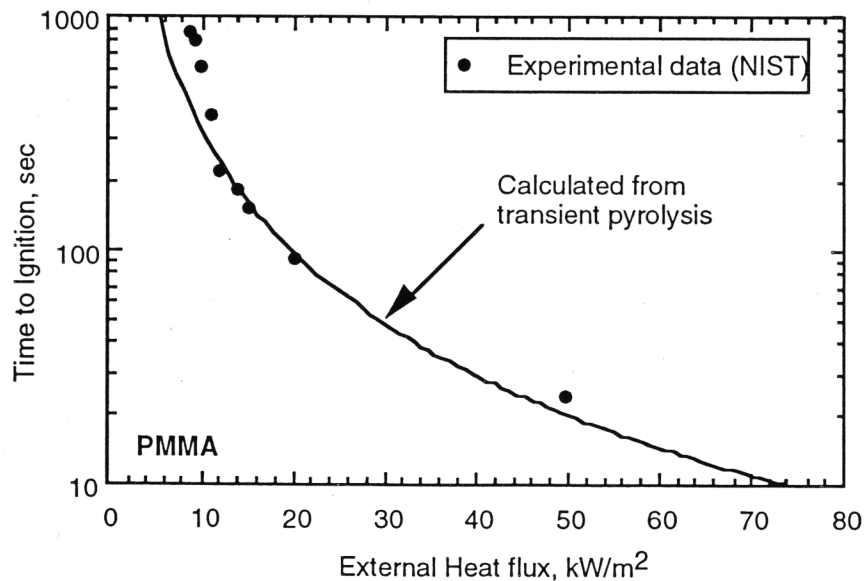


Figure 2. Calculated and measured time-to-ignition for PMMA assuming  $T_{ign} = T_p^{max}$

Since it is found that the molar heat of depolymerization (gasification) is numerically equal to the molar activation energy for pyrolysis,  $E_a$ , the heat of gasification *per unit mass*,  $L_g$ , is related to the molar activation energy for pyrolysis through the molecular weight of the decomposition products,  $M_g$ ,

$$L_g = \frac{\Delta H_a}{M_g} = \frac{E_a}{M_g} \quad (19)$$

Polymers which pyrolyze to monomer (depolymerize) at near-quantitative yield such as polymethylmethacrylate, polyoxymethylene, and polystyrene, should have  $M_g$  equal to the monomer molecular weight,  $M_o$ , i.e.,  $M_g/M_o \approx 1$ . Polymers such as polyethylene and polypropylene which decompose by random scission to multi-monomer fragments would have  $M_g/M_o > 1$ . In contrast, polymers with high molecular weight repeat units ( $M_o \geq 200$  g/mol) such as nylon, cellulose, polycarbonate, or with good leaving groups (e.g., polyvinylchloride) are known to yield primarily low molecular weight species (water, carbon dioxide, alkanes, HCl) on pyrolysis and should have,  $M_g/M_o < 1$ .

The Table shows the ratio  $M_g/M_o$  predicted from the relation

$$\frac{E_a/M_o}{L_g} = \frac{M_g}{M_o} \quad (20)$$

for a variety of common polymers for which  $L_g$  has been measured [8].

Heat of Gasification [8], Thermal Activation Energy [3,9], and Calculated Molecular Weight of Decomposition Products for Common Polymers with Known Pyrolysis Modes [9].

POLYMER	$M_o$ (g/mol)	$L_g$ (kJ/g)	$E_a$ (kJ/mol)	$M_g / M_o$	PYROLYSIS PRODUCTS
polypropylene	42	2.5	243	2.3	C <sub>2</sub> - C <sub>90</sub> saturated and unsaturated hydrocarbons
polyethylene	28	2.4	264	3.9	
polystyrene	104	2.2	230	1.0	40-60% monomer
polymethylmethacrylate	100	1.6	160	1.0	100% monomer
polyoxymethylene	30	2.7	84	1.0	100% monomer
nylon 6,6	226	2.6	160	0.3	H <sub>2</sub> O , CO <sub>2</sub> , C <sub>5</sub> HC's
cellulose	162	3.2	200	0.4	H <sub>2</sub> O , CO <sub>2</sub> , CO
polyvinylchloride	62	2.5	110	0.7	HCl, benzene, toluene

The qualitative agreement between the observed modes of pyrolysis (random scission, depolymerization, solid-phase combustion/fragmentation) and the calculated fragment molecular weight using Equation 20 is strong support for the identity,  $L_g = E_a/M_g$ . Consequently,  $L_g$  determined experimentally from a plot of peak mass loss rate versus external heat flux has the significance of a thermodynamic property. From Equations 18 and 19 the effective mass loss rate in terms of the net heat flux to the surface, is

$$\dot{m}_A = \frac{\dot{Q}_{net}}{L_g} = \frac{M_g}{E_a} \dot{Q}_{net} \quad (21)$$

## HEAT RELEASE RATE

The phenomenological equation relating mass loss rate to heat release rate is,

$$\dot{Q}_c \text{ (kW/m}^2\text{)} = \chi \Delta H_c \dot{m}_A \quad (22)$$

where  $\chi$ ,  $\Delta H_c$ , and  $\dot{m}_A$ , are the combustion efficiency, chemical heat of complete combustion, and the mass loss rate per unit area, respectively. Substituting Equation 13 for the areal mass loss rate of a char forming polymer into Equation 22 gives the heat release rate of a burning polymer in terms of its flaming surface temperature as

$$\dot{Q}_c = \Delta H_c \chi \dot{m}_A = \chi(1-Y_c) \Delta H_c \left[ \frac{\kappa \rho}{C_p} \frac{A}{50e} \right]^{1/2} \exp\left(-\frac{E_a}{2RT_s}\right) \quad (23)$$

Figure 6 shows the excellent correlation ( $r^2 = 0.94$ ) between steady-state heat release rate calculated from Equation 23 and measured values for a wide variety of polymers for which heat release rate data (10-13) and char yields (3,9,13) were available as well as reliable kinetic parameters (3,9,10) for the calculation of the flaming surface temperature,  $T_s \approx T_p^{\max}$  at an external heat flux of 50 kW/m<sup>2</sup>.

In terms of the net heat flux to the surface, the heat release rate from Equations 21 and 22 is

$$\dot{Q}_c = \frac{\chi \Delta H_c M_g}{E_a} \dot{Q}_{\text{net}} \quad (24)$$

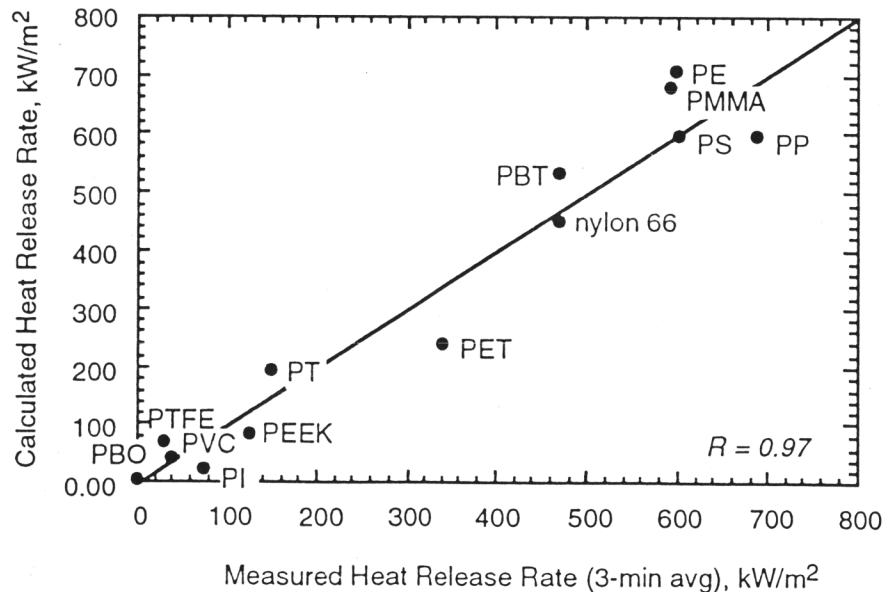


Figure 6. Calculated versus measured heat release rate for a variety of polymers

## SUMMARY

The objective of this work was to find simple relationships between the fire response of polymeric materials and their thermodynamic, kinetic, and transport properties. Polymer thermal stability was assumed to be completely described by first-order Arrhenius pyrolysis kinetics modified to account for char yield. Analytic expressions for the time-to-ignition, mass loss rate, heat of gasification, and heat release rate were developed from phenomenological equations, transient heat conduction analyses, and the Arrhenius parameters and thermal properties of the material. Qualitative agreement between predicted and experimental fire response data for a wide range of polymeric materials is obtained by this simple approach.

## REFERENCES

1. R.E. Lyon, "Fire-Safe Aircraft Cabin Materials," in Fire and Polymers, ACS Symposium Series Number 599, G.L. Nelson, ed., American Chemical Society, Washington, D.C., p. 618, 1995
2. Kashiwagi, T.; Omori, A., Twenty-Second Symposium (International) on Combustion, The Combustion Institute: Pittsburgh, PA, pp. 1329-13382, 1988
3. Polymer Handbook, Brandrup, J.; Immergut, E.H., Eds.; 2nd edition; Wiley-Interscience: NY, 1975
4. Tewarson, A., "Flammability Parameters of Materials: Ignition, Combustion, and Flame Spread," Proceedings of the International Conference for the Promotion of Advanced Fire Resistant Aircraft Materials, Atlantic City, New Jersey, Feb. 9-11, pp. 263, 1993
5. Quintiere, J.G.; Harkelroad, M.T.; "New Concepts for Measuring Flame Spread Properties," in Fire Safety: Science and Engineering, Harmathy, T.Z, ed; ASTM Special Technical Publication 882: Phila., PA, pp. 239-267, 1985
6. T.Y. Toong, Combustion Dynamics: The Dynamics of Chemically Reacting Fluids, McGraw Hill, New York, 1983
7. Kishore, K., and Pai Veneker, V.R., "Correlation Between Heats of Depolymerization and Activation Energies in the Degradation of Polymers," J.Polym.Sci.:Polym.Lett. Ed., **14**, 761 (1976)
8. Tewarson, A., "Generation of Heat and Chemical Compounds in Fires," SFPE Handbook of Fire Protection Engineering; P.J. DiNenno, ed.; National Fire Protection Association Press: Quincy, MA, Section 1, Chapter 13, pp. 1-179, 1988
9. D.W. Van Krevelen, Properties of Polymers, Elsevier Scientific, NY, 1976
10. Kim, P.K., Pierini, P., and Wessling, R., "Thermal and Flammability Properties of Poly(p-phenylene-benzobisoxazole)," Proceedings of the Thirty-Ninth Sagamore Army Materials Research Conference, Plymouth, MA, 14-17 September, 1992, pp. 327-335
11. Hirschler, M.M., "Heat Release From Plastic Materials," in Heat Release in Fires, V. Babrauskas and S. Grayson, Eds., Elsevier Applied Science, New York, Chapter 12(a), pp. 375-422, 1992
12. Scudamore, M.J., Briggs, P.J. and Prager, F.H., "Cone Calorimetry—A Review of Tests Carried out on Plastics for the Association of Plastic Manufacturers in Europe," Fire and Materials, **15**, 65-84 (1991)
13. Grand, A.F., SBIR Phase I Progress Report, 1995, Contract No. DTRS-57-94-C-00172