

F550000007A04
J J Gasovann
141

AIRCRAFT FIRE EXTINGUISHMENT
PART III
AN INSTRUMENT FOR EVALUATING
EXTINGUISHING SYSTEMS

By
James D. New and Charles M. Middlesworth
Aircraft Division

Technical Development Report No. 206

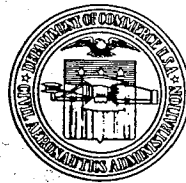

CIVIL AERONAUTICS ADMINISTRATION
TECHNICAL DEVELOPMENT AND
EVALUATION CENTER
INDIANAPOLIS, INDIANA

June 1953

U. S. DEPARTMENT OF COMMERCE

Sinclair Weeks, Secretary

CIVIL AERONAUTICS ADMINISTRATION

F. B. Lee, Administrator

D. M. Stuart, Director, Technical Development and Evaluation Center

This is a technical information report and does not necessarily represent CAA policy in all respects.

TABLE OF CONTENTS

	Page
SUMMARY	1
INTRODUCTION	1
DESCRIPTION OF INSTRUMENT	1
DATA REDUCTION	4
OPERATING PROCEDURE	6
TESTS	6
CONCLUSIONS	11
RECOMMENDATIONS	11

Information and illustrations contained in this report under the sections entitled "Description of Instrument" and "Data Reduction" were obtained from the Service Manual provided by Statham Laboratories, Inc., under contract with the Department of the Air Force.

AIRCRAFT FIRE EXTINGUISHMENT

PART III

AN INSTRUMENT FOR EVALUATING EXTINGUISHING SYSTEMS

SUMMARY

A gas analyzer for evaluating aircraft fire-extinguishing systems was calibrated for use with carbon dioxide, methyl bromide, and bromochloromethane. Extensive application of the analyzer in evaluating the carbon dioxide system of the XB-45 power plant proved it to be of practical value. Operation of the instrument in flight proved satisfactory.

INTRODUCTION

A difficult problem associated with aircraft fire protection is the proper distribution of an extinguishing agent in the various fire zones. Heretofore, the distribution of the agent and the resulting concentrations have not been measured. In most instances a complete fire-testing program is impractical, and extinguishing-system evaluation is based on rate calculations, visual observations, and measurements of the duration of discharge. These indirect and inadequate methods have been unsatisfactory, and the need for an instrument capable of recording the percentage and duration of agent concentration in nacelle compartments has been evident. Such an instrument would provide a practical means for evaluating aircraft fire-control measures and would represent a tool essential to such evaluation by manufacturers, operators, or safety inspectors.

To meet this need, the Department of the Air Force developed an experimental continuous type of gas analyzer, the operation of which was based on the differences in flow characteristics of gases. Successful operation of this experimental analyzer led to the preparation of specifications by the Department of the Air Force for an 18-channel prototypal instrument, a model of which was built by Statham Laboratories of Los Angeles, California.

In general, these specifications called for an instrument capable of furnishing a continuous recording of gases drawn from 18 regions. The recording was to be accomplished at a high rate of speed, since the total discharge time of an aircraft extinguishing system does not normally exceed two seconds and concentrations may change 100 per cent during 1/10-second intervals. The

error was not to exceed ± 3 per cent for any constant concentration in the range from 0 to 100 per cent. The analyzer was to be accurate for normal variations in sample temperature and pressure and was to be entirely suitable for application in aircraft.

The purpose of this investigation was to further the development of the Statham Model GA-1 analyzer as an instrument for evaluating aircraft power-plant fire-extinguishing systems by: (1) calibrating the instrument for use with conventional extinguishing agents, and (2) determining its operating characteristics and performance under conditions of proposed usage.

DESCRIPTION OF INSTRUMENT

The Model GA-1, Serial 1, analyzer was manufactured by Statham Laboratories, Inc., for the Department of the Air Force and was calibrated by the Technical Development and Evaluation Center of the Civil Aeronautics Administration.

The analyzer and its accessories were designed to provide a high-speed continuous recording of the concentration of extinguishing gas present in 18 different regions during a given time. It is based on a development described in the Air Force Exhibit TSEPE-8E-4-A dated January 31, 1947. The analyzer sensing element consists of a thermally insulated and temperature-regulated metal assembly with a series of machined holes through which the samples pass. In each of these paths are fitted two plugs of porous metal and an orifice. When the gases pass through the second plug, there occurs a measured pressure drop which varies with the viscosity and the volumetric flow rate of the gas. When the sample passes through the orifice, critical flow results. The pressure drop developed across the second plug operates a transducer, the output of which is recorded by a remotely connected oscillograph.

The design of the analyzer unit is such that an instantaneous change from air to carbon dioxide at the inlet of the analyzer will cause the recording oscillograph to sweep at least 95 per cent of the total displacement during an interval of 0.10 second. If a six-foot sampling tube is used to bring the sample

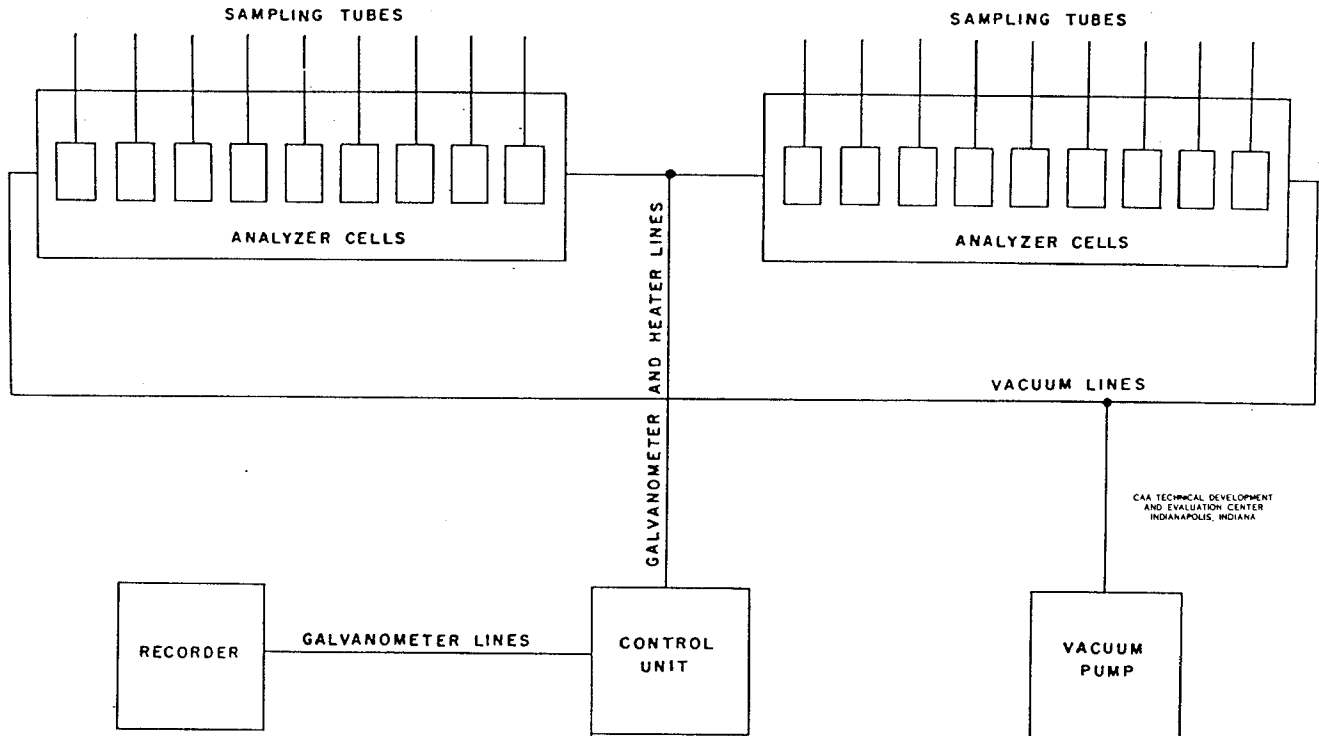

Fig. 1 Components of Model GA-1 Analyzer

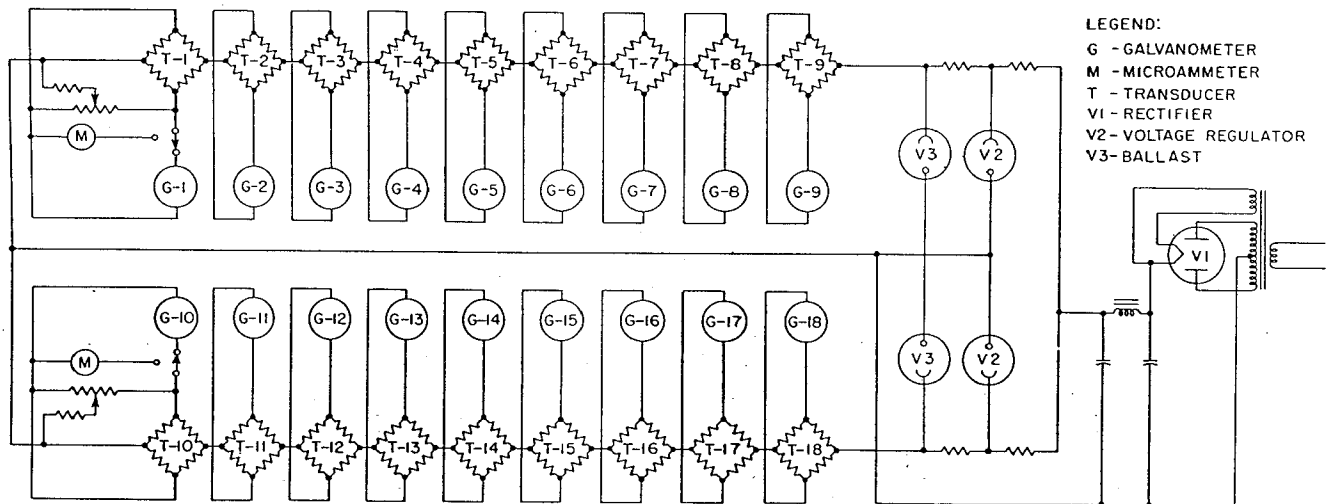

Fig. 2 Electrical Schematic Diagram of the Statham Gas Analyzer

to the analyzer unit, the rate of response will be reduced to 0.25 second because of diffusion of the mixture in the sampling tube.

The analyzer was designed for operation in aircraft and operates from a 24-volt direct current (d-c) and from a 115-volt, 400-cycle per second (cps) power supply.

The complete instrument consists of the following components:

- Two analyzer units.
- One control unit.

- One recorder.
- One vacuum pump.
- Sampling tubes.
- Connecting cables.

Fig. 1 shows the relationship between the component parts when arranged for use. Fig. 2 is a simplified electrical diagram of the analyzer, which contains two analyzer units.

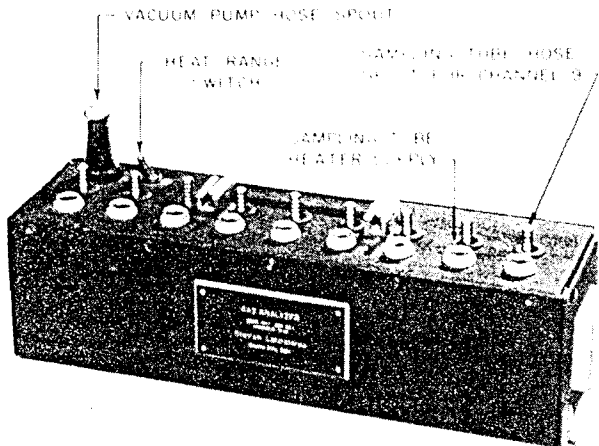

CALTECH TECHNICAL DEVELOPMENT
AND EVALUATION CENTER
INDIANAPOLIS, INDIANA

Fig. 3 Exterior of Analyzer Unit

Analyzer Units.

Each analyzer unit consists of nine Statham transducers with their associated vacuum and electrical connections, as shown in Figs. 3 and 4. Details of the construction of a single analyzer cell showing the transducer, the porous plugs, and the orifice are illustrated in Fig. 5.

The pressure drop which occurs across the second porous plug (shown in Fig. 5) will vary with the composition of the sample, since both the viscosity and the rate of flow usually change when the make-up of the sample changes. For a given channel, each pure gas will always result in a definite pressure drop; and for any mixture of two gases, the pressure drop will be some definite value between the respective values for the pure constituents. If two gases have nearly identical pressure drops, their proportions in a mixture cannot be determined. However, any proportion of two or more gases which have a similar pressure drop can be treated as a single gas when the percentages of some other gas which has a substantially different pressure drop are determined. Any gas mixture which always has the same composition, such as dry air, may be treated as a pure gas.

The metal block is maintained at a constant temperature by a thermostatically controlled dual heater. Provision is made in the control unit for keeping either one or both sections of the heater in the circuit. Both sections should be used to reduce the warm-up time. After the operating temperature is reached, one section should be cut out. For exceedingly low ambient temperatures, both sections of the heater may be left on.

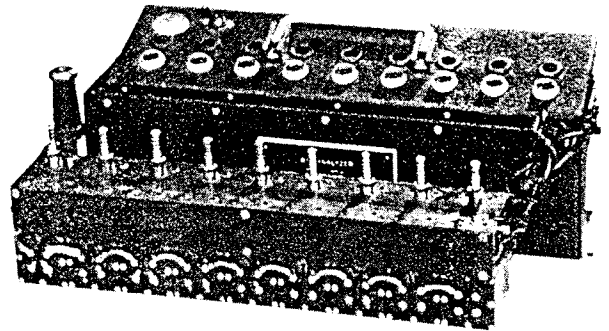

CALTECH TECHNICAL DEVELOPMENT
AND EVALUATION CENTER
INDIANAPOLIS, INDIANA

Fig. 4 Interior of Analyzer Unit

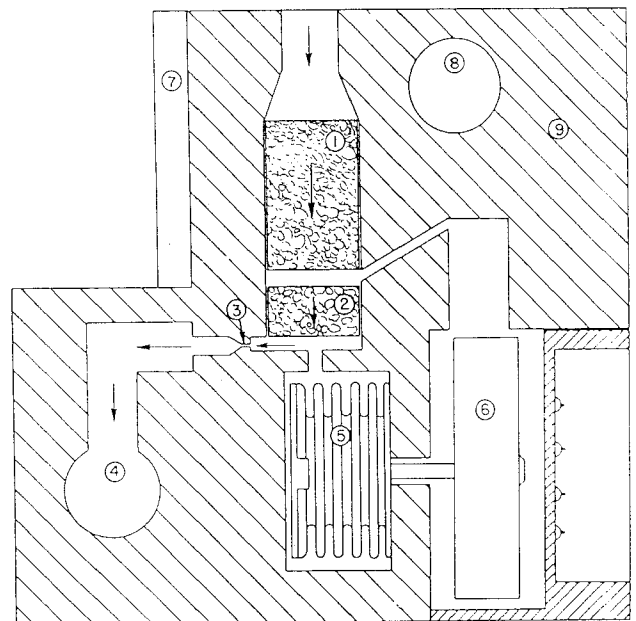

- 1 - TEMPERATURE-REGULATING POROUS PLUG
 - 2 - PRESSURE-DROP POROUS PLUG
 - 3 - ORIFICE
 - 4 - VACUUM MANIFOLD
 - 5 - PRESSURE-SENSITIVE BELLOWS
 - 6 - STATHAM STRAIN GAGE
 - 7 - HEATING ELEMENT
 - 8 - THERMOSTAT TEMPERATURE CONTROL
 - 9 - METAL BLOCK
- } TRANSDUCER ASSEMBLY

CALTECH TECHNICAL DEVELOPMENT
AND EVALUATION CENTER
INDIANAPOLIS, INDIANA

Fig. 5 Typical Analyzer Cell

Control Unit.

The control unit shown in Figs. 6 and 7 contains the control circuits for the analyzer units and also the heated type of sampling tubes. It serves as a power supply and as a

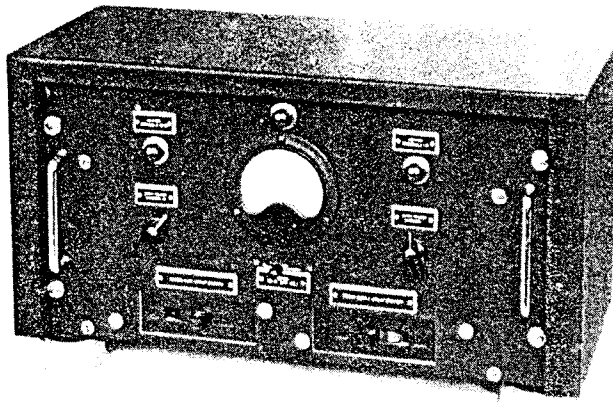

AA TECHNICAL DEVELOPMENT
AND EVALUATION CENTER
INDIANAPOLIS, INDIANA

Fig. 6 Exterior of Control Unit

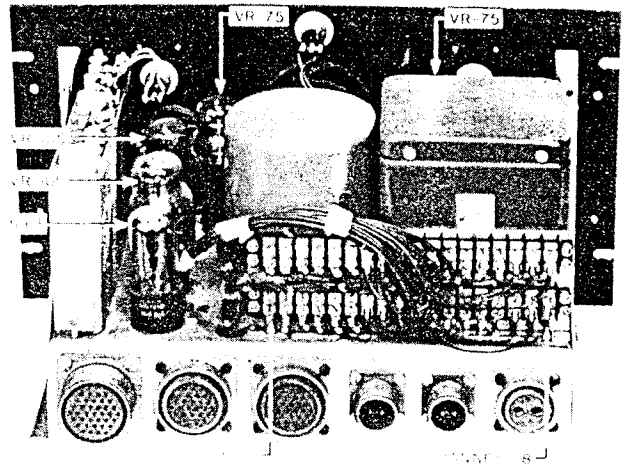

AA TECHNICAL DEVELOPMENT
AND EVALUATION CENTER
INDIANAPOLIS, INDIANA

Fig. 7 Interior of Control Unit

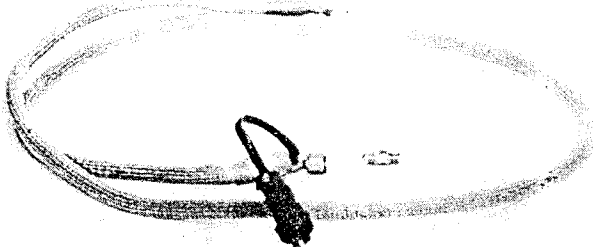

AA TECHNICAL DEVELOPMENT
AND EVALUATION CENTER
INDIANAPOLIS, INDIANA

Fig. 8 Sampling Tube

connection panel for the analyzers and the recorder. This unit utilizes two VR-105 regulator tubes and two VR-75 ballast tubes to furnish a regulated power supply to the transducers. The circuit breaker for the vacuum pump is also on the control-unit panel.

Recorder.

The Model GA-1 analyzer is designed to be used with an 18-channel oscillograph which uses Heiland Type G-150 galvanometers or their equivalent.

Vacuum Pump.

The vacuum pump used with the analyzer operates on 24 volts d-c and provides the means by which the gas samples are pulled through the 18 analyzer cells.

Sampling Tubes.

Six-foot sampling tubes are provided for conducting the sample to the analyzer.

These tubes are constructed of soft copper tubing and are electrically heated over their entire length. This is necessary for use with agents whose boiling points indicate the need for preheated sampling tubes. For such use, care must be exercised in the orientation of the mouth of the sampling tubes so that no spray will enter. The Model GA-1 analyzer is only designed to analyze samples in the gaseous state or in a finely divided suspension.

In order to prevent the heat exchanger from becoming clogged with any fine suspensions that might be carried in by the gas, the sampling tubes are terminated in a porous metallic disc. Fig. 8 shows the filter assembly and the heater type of sampling tube.

DATA REDUCTION

The differential pressure across the second porous plug is proportional to the viscosity of the gas and the volumetric rate of flow, expressed as:

$$dp = C_1 uv \quad (1)$$

where

C_1 = constant depending on the gas,

dp = the differential pressure,

u = the viscosity of the gas,

v = the volumetric rate of flow of the gas.

If deviations from the pure-gas law are neglected, the volumetric rate of flow is given by:

$$v = \frac{C_2}{\sqrt{W}} \sqrt{k \left[\frac{2}{k+1} \right]^{\frac{k+1}{k-1}}} \quad (2)$$

where

W = the molecular weight of the gas,

k = the ratio of specific heats,

C₂ = constant.

When Equation (2) is substituted in Equation (1):

$$dp = \frac{C_3 u}{\sqrt{W}} \sqrt{k \left[\frac{2}{k+1} \right]^{\frac{k+1}{k-1}}} \quad (3)$$

where

C₃ = a constant depending upon the orifice area, the resistance of the porous plug, and the operating temperature of the analyzer.

To evaluate the constant C₃ it is necessary to obtain the pressure differential, as given by the galvanometer deflection, by passing air through the analyzer. This deflection in inches multiplied by the ratio in Equation (4) gives the deflection in inches corresponding to a 100 per cent concentration of the gas.

$$R = \frac{\sqrt{\frac{u}{W}} \sqrt{k \left[\frac{2}{k+1} \right]^{\frac{k+1}{k-1}}}}{\sqrt{\frac{u}{W}} \sqrt{k \left[\frac{2}{k+1} \right]^{\frac{k+1}{k-1}}}} \quad (4)$$

(for gas) (for air)

The calculated theoretical values of this ratio for carbon dioxide, methyl bromide, and bromochloromethane are:

Air	1.00
Carbon dioxide	0.64
Methyl bromide	0.375
Bromochloromethane	0.316

Although Equation (1) contains no term for the pressure of the sample, large changes

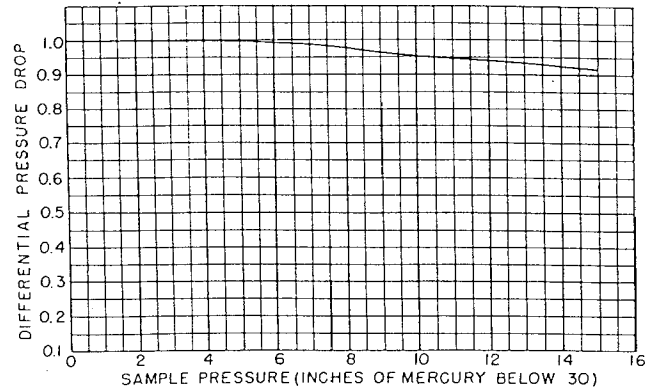

CAA TECHNICAL DEVELOPMENT
AND EVALUATION CENTER
INDIANAPOLIS, INDIANA

Fig. 9 Effect of Sample Pressure on the Differential Pressure Drop for Air

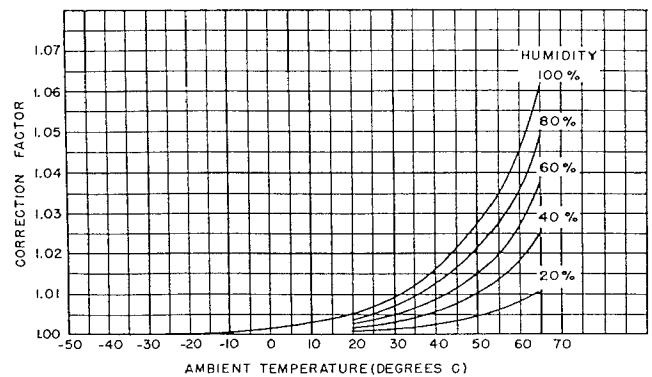

CAA TECHNICAL DEVELOPMENT
AND EVALUATION CENTER
INDIANAPOLIS, INDIANA

Fig. 10 Humidity Correction Factors

in the ambient pressure will cause small variations in dp because the ratio of specific heat k is a function of pressure. Fig. 9 shows the effect of sample pressure on the differential pressure for air. Fortunately, the ratio between the drop in pressure for any two gases remains essentially constant for large changes in sample pressure. Because the change in the pressure drop is small even for large changes in the pressure of the sample, the effect of fluctuating pressure may ordinarily be disregarded. Under extreme conditions, it is necessary to recalibrate the analyzer units by obtaining a new deflection reading for air. The same displacement ratios may then be used.

The theoretical ratios are based on the pressure drop obtained for dry air. If there is an appreciable amount of moisture in the air, a slight error will result from the use of these ratios. Fig. 10 gives the correction factor by which the ratios must be multiplied

for the specific humidity and ambient-temperature conditions existing at the time of the calibration. It will be noted that, except for extreme conditions, the effect of humidity may be disregarded.

OPERATING PROCEDURE

Operation of the instrument as a gas analyzer consists simply of bringing the metal block up to the correct temperature and then drawing the gas sample through the porous plugs and the critical orifice. The resulting pressure differential across the second porous plug causes the sensitive bellows of the transducer to react upon the strain-gage unit, which in turn directs a proportional amount of the current flowing through the strain gage into the galvanometer circuit. The resulting deflection of the galvanometer trace is recorded continuously in the oscillograph. The displacement of this trace is proportional to the pressure drop across the second porous plug and is measured in inches.

To calibrate the instrument for a specific gas such as carbon dioxide, the displacement in inches for carbon dioxide is ascertained. This displacement, when expressed as a percentage of that obtained for air, represents the calibration-displacement ratio. Subsequently, the concentration of carbon dioxide in any mixture of carbon dioxide and air may be determined by the formula:

$$\% \text{CO}_2 = \frac{\text{AD} - \text{MD}}{\text{AD} - \text{CD}} \times 100$$

where

AD = displacement for air in inches,

MD = displacement for mixture in inches,

CD = displacement for CO₂ in inches.

TESTS

The tests conducted on the analyzer at this Center consisted of: (1) calibration tests to check the theoretical calibration ratios, (2) service trials by application of the analyzer for evaluating the fire-extinguishing system of the XB-45 airplane nacelle, and (3) flight trials to determine instrument characteristics under flight conditions.

Calibration Tests.

A. Carbon Dioxide.

To calibrate the instrument for carbon dioxide, the displacement for a 100 per cent

concentration was ascertained. The apparatus used for this test is shown in Fig. 11. The sampling tubes were bundled together and terminated in the center and just above the bottom of the gas chamber. Within this bundle was an additional tube for conducting a sample to an Orsat analyzer. There was also connected to this sealed chamber a 50-pound carbon dioxide cylinder with a hand-operated valve. High concentrations of carbon dioxide were obtained by first evacuating air from the chamber and then repeatedly flooding the chamber from the 50-pound cylinder. This flooding was repeated until the Orsat measured a high concentration of carbon dioxide. Simultaneous readings were then taken with the Statham and the Orsat analyzers. This test procedure was repeated several times to determine the consistency of the answers recorded by the instrument. Twelve of the eighteen channels were used in the tests.

The results of tests which included two recordings of 100 per cent air (Tests 2221 and 2223) and three of a high carbon dioxide concentration (Tests 2222, 2224, and 2225) are given in Table I. The information from 12 channels is tabulated, and an average value of the calibration ratio for carbon dioxide is given.

In explanation of the figures in the table, the results for channel 1 in Tests 2221 and 2222 are more fully described as follows:

1. The measured displacement on the oscillograph record of a 100 per cent air sample was 3.02 inches.

2. The theoretical displacement for 100 per cent carbon dioxide would then be $3.02 \times 0.64 = 1.93$ inches, since 0.64 is the theoretical calibration ratio, as listed previously for carbon dioxide.

3. The difference between displacements resulting from 100 per cent air and 100 per cent carbon dioxide is then calculated as $3.02 - 1.93 = 1.09$ inches.

4. The difference between displacements resulting from 100 per cent air and 96.5 per cent carbon dioxide (Orsat value) was measured as 0.79 inch.

5. By extrapolation, the difference between displacements resulting from 100 per cent air and 100 per cent carbon dioxide

would be $\frac{100}{96.5} \times 0.79 = 0.82$ inch.

6. The calibration ratio by actual measurement then equals $\frac{(3.02 - 0.82)}{3.02} = 0.73$.

The average carbon dioxide calibration ratio for channel No. 1 determined from tests was 0.73.

TABLE I
 CALIBRATION TEST DATA OF ANALYZER
 MODEL GA-1, SERIAL I
 USING CARBON DIOXIDE AS THE AGENT

Test Run No.	Item	Analyzer Cell Channel Number											
		1	2	3	4	5	6	10	11	12	13	14	15
2221	MD (100% air)	3.02	2.81	2.94	2.88	2.64	2.71	2.87	2.62	2.74	2.62	2.80	2.88
	TD (100% CO ₂)	1.93	1.80	1.88	1.84	1.69	1.73	1.84	1.68	1.75	1.68	1.79	1.84
	TDD	1.09	1.01	1.06	1.04	0.95	0.98	1.03	0.94	0.99	0.94	1.01	1.04
2222	MDD (96.5% CO ₂)*	0.79	0.71	0.71	0.63	0.68	0.73	0.76	0.67	0.71	0.69	0.75	0.79
	CDD	0.82	0.74	0.74	0.65	0.70	0.76	0.79	0.70	0.74	0.71	0.78	0.82
2223	MD (100% air)	3.00	2.79	2.93	2.84	2.61	2.68	2.87	2.61	2.73	2.62	2.80	2.89
	TD (100% CO ₂)	1.92	1.79	1.88	1.82	1.67	1.72	1.84	1.67	1.75	1.68	1.79	1.85
	TDD	1.08	1.00	1.05	1.02	0.94	0.96	1.03	0.94	0.98	0.94	1.01	1.04
2224	MDD (91.3% CO ₂)*	0.76	0.68	0.69	0.58	0.66	0.67	0.76	0.64	0.69	0.67	0.72	0.76
	CDD	0.83	0.75	0.76	0.64	0.72	0.73	0.83	0.70	0.76	0.73	0.79	0.83
2225	MDD (96.2% CO ₂)*	0.79	0.73	0.72	0.62	0.69	0.71	0.78	0.67	0.73	0.69	0.74	0.79
	CDD	0.82	0.76	0.75	0.65	0.72	0.74	0.81	0.70	0.76	0.72	0.77	0.82
2222	AR	0.73	0.74	0.75	0.77	0.73	0.72	0.72	0.73	0.73	0.73	0.72	0.72
2224	AR	0.72	0.73	0.74	0.77	0.72	0.73	0.71	0.73	0.72	0.72	0.72	0.71
2225	AR	0.73	0.73	0.74	0.77	0.72	0.73	0.70	0.73	0.72	0.73	0.73	0.72
Average Ratios		0.73	0.73	0.74	0.77	0.72	0.73	0.71	0.73	0.72	0.73	0.72	0.72

Over-All Average of Ratios = 0.73

*CO₂ Concentration as measured by Orsat analyzer.

LEGEND:

MD (100% air)	Measured displacement by 100 per cent air sample.
TD (100% CO ₂)	Theoretical displacement by 100 per cent CO ₂ = displacement for air x 0.64.
TDD	Theoretical displacement difference between 100 per cent air and 100 per cent CO ₂ .
MDD	Measured displacement difference equals MD for 100 per cent air minus MD for CO ₂ sample.
CDD	Calculated displacement difference between 100 per cent air and 100 per cent CO ₂ .
AR	Actual ratios of displacements.

NOTE: Channels 7, 8, and 9 were inoperative at the time of testing.

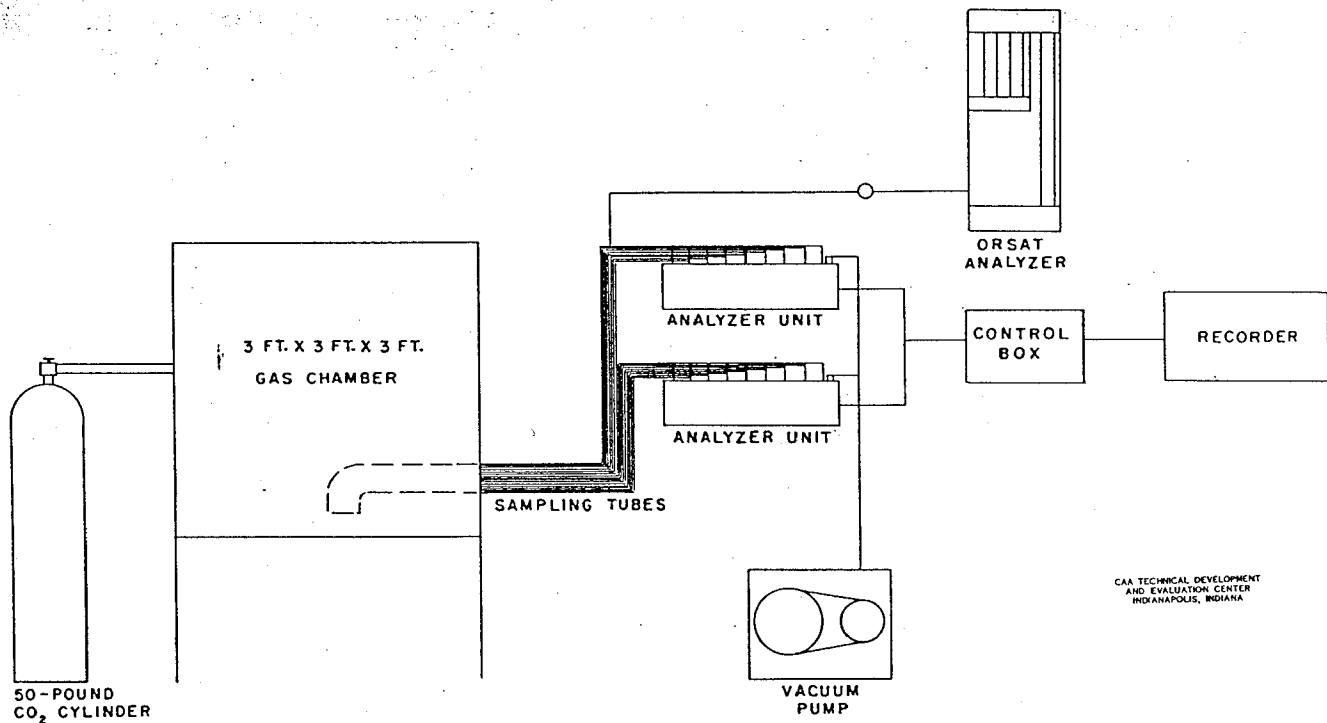

Fig. 11 Test Apparatus for CO₂ Calibration Tests

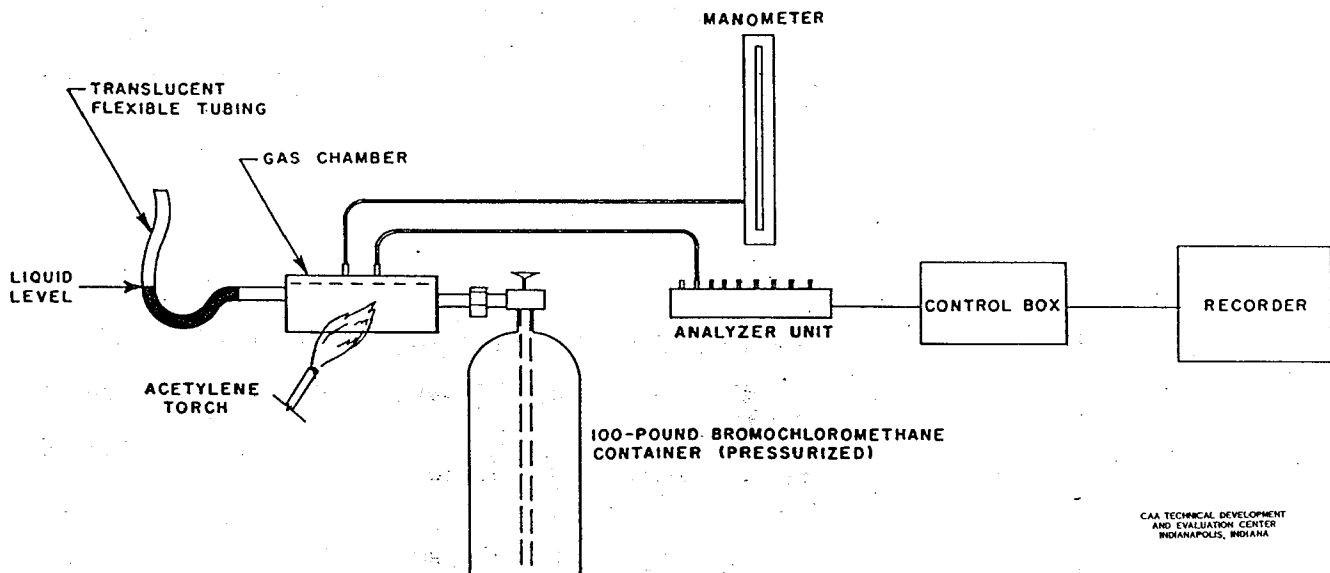

Fig. 12 Test Apparatus for Bromochloromethane Calibration Tests

The average carbon dioxide calibration ratio for 12 channels was also 0.73.

In addition to the foregoing tests, a considerable number of recordings were made of lower carbon dioxide concentrations which ranged between 25 and 75 per cent carbon dioxide, as measured with the Orsat apparatus. By the use of the measured calibration ratio for data interpretation, the

concentrations were determined from analyzer recordings. These values were found to agree within 5 per cent of full scale with the Orsat readings and confirmed the validity of the method of data interpretation.

B. Bromochloromethane.

Fig. 12 shows the apparatus used to obtain a concentration of 100 per cent

bromochloromethane (CH_2BrCl) vapor. A supply cylinder containing 100 pounds of bromochloromethane was pressurized with nitrogen. Attached to this supply cylinder was a 12-inch long, 8-inch diameter sampling chamber with sampling tubes connected at the top. A short length of translucent rubber tubing was affixed to the overflow end of the chamber to determine the liquid level in it and to prevent air from leaking into it. The liquid level was maintained at approximately one inch from the top. To assure a supply of bromochloromethane vapor in the top of the chamber, heat was applied to the liquid by an acetylene torch. A manometer was connected to this vapor space; and by adjustment of the amount of heat applied, the vapor pressure was maintained at zero while the sample was drawn out through the analyzer. For these tests, a single sampling tube was used alternately connected to each channel.

The procedure for determining actual displacement for 100 per cent bromochloromethane was the same as for carbon dioxide. Results of calibration tests for bromochloromethane are shown in Table II. The actual measured ratio of displacements for 100 per cent bromochloromethane to 100 per cent air was 0.40.

At the conclusion of the sampling test of bromochloromethane, additional tests were made to observe the effects of sampling pressure on the recorded displacement. This condition was controlled by applying enough heat to the liquid bromochloromethane in the sampling chamber to result in a maximum vapor pressure of 12 inches of water while the sample was being drawn from the chamber. The heat was also adjusted to result in a negative vapor pressure of 9 inches of water. No appreciable effect resulted from these differences in sample pressure.

TABLE II
CALIBRATION TEST DATA OF ANALYZER
MODEL GA-1, SERIAL I
USING BROMOCHLOROMETHANE AS THE AGENT

Item	Analyzer Cell Channel Number											
	1	2	3	4	5	6	10	11	12	13	14	15
MD (100% air)	2.83	2.71	2.88	2.70	2.56	2.53	2.73	2.51	2.59	2.46	2.63	2.75
TD (100% CH_2BrCl)	0.90	0.86	0.91	0.86	0.81	0.80	0.86	0.80	0.82	0.78	0.83	0.87
TDD	1.93	1.85	1.97	1.84	1.75	1.73	1.87	1.71	1.77	1.68	1.80	1.88
MD (100% CH_2BrCl)	1.13	1.11	1.13	1.15	1.04	1.02	1.26	0.99	1.02	0.97	1.04	1.06
CDD	1.70	1.60	1.25	1.55	1.52	1.51	1.47	1.52	1.57	1.49	1.59	1.69
Actual Test Ratios												
$\left(\frac{\text{CH}_2\text{BrCl}}{\text{Air}}\right)$	0.40	0.40	0.39	0.42	0.40	0.40	0.46	0.39	0.40	0.40	0.40	0.40

Average of Actual Test Ratios $\left(\frac{\text{CH}_2\text{BrCl}}{\text{Air}}\right)$ for all channels = 0.40

LEGEND:

MD (100% air)	Measured displacement by 100 per cent air sample.
TD (100% CH_2BrCl)	Theoretical displacement by 100 per cent bromochloromethane sample = MD (100% air x 0.316).
TDD	Theoretical displacement difference between 100 per cent air and 100 per cent CH_2BrCl .
CDD	Calculated displacement difference between 100 per cent air and 100 per cent CH_2BrCl .

NOTE: Channels 7, 8, and 9 were inoperative at the time of testing.

TABLE III
 CALIBRATION TEST DATA OF ANALYZER
 MODEL GA-1, SERIAL I
 USING METHYL BROMIDE AS THE AGENT

Item	Analyzer Cell Channel Number											
	1	2	3	4	5	6	10	11	12	13	14	15
MD (100% air)	2.96	2.83	2.98	2.75	2.65	2.62	2.85	2.58	2.71	2.60	2.79	2.87
TD (100% CH ₃ Br)	1.11	1.06	1.12	1.03	0.99	0.99	1.07	0.97	1.02	0.98	1.05	1.08
TDD	1.85	1.77	1.86	1.72	1.66	1.63	1.78	1.61	1.69	1.62	1.74	1.79
MD (100% CH ₃ Br)	1.53	1.50	1.53	1.50	1.37	1.34	1.44	1.33	1.42	1.32	1.42	1.50
CDD	1.43	1.33	1.45	1.25	1.28	1.28	1.41	1.25	1.29	1.28	1.37	1.37
Actual Test Ratios												
$\frac{(\text{CH}_3\text{Br})}{(\text{Air})}$	0.51	0.53	0.50	0.54	0.51	0.51	0.50	0.51	0.52	0.51	0.51	0.52

Average of Actual Test Ratios for all Channels = 0.51

LEGEND:

- MD (100% air) Measured displacement by 100 per cent air sample.
- TD (100% CH₃Br) Theoretical displacement by 100 per cent CH₃Br sample.
- TDD Theoretical displacement difference between 100 per cent air and 100 per cent CH₃Br.
- CDD Calculated displacement difference between 100 per cent air and 100 per cent CH₃Br.

NOTE: Channels 7, 8, and 9 were inoperative at the time of testing.

C. Methyl Bromide.

The procedure for calibrating the instrument for methyl bromide was identical to that for bromochloromethane. The only notable difference was the requirement of less heat to maintain the vapor supply in the chamber. Table III gives data from a typical series of tests.

The actual measured ratio of displacements for 100 per cent methyl bromide to 100 per cent air was 0.51.

Summary of Calibration Tests.

The calibration ratios,

$\frac{\text{galvanometer deflection for 100 per cent agent}}{\text{galvanometer deflection for 100 per cent air}}$,

were determined from the tests to be as follows:

Air	1.00
Carbon dioxide	0.73
Methyl bromide	0.51
Bromochloromethane	0.40

These values, rather than the theoretical calculated values shown previously under "Data Reduction," should be used in the interpretation of the analyzer recordings. Although differing from the theoretical values, the calibration ratios determined by tests were consistent within reasonable and usable limits for different test runs and for the several channels. Thus, the need for actual instrument calibration is indicated as being essential to the accurate interpretation of the data. The reasons for the differences between the theoretical and the measured displacement ratios were not determined. Such differences may primarily be due to departure from the pure-gas law.

Service Tests.

Service characteristics of the analyzer were studied by the utilization of the instrument in simulated flight fire-testing of a B-45 airplane nacelle. Time-concentration curves at numerous locations throughout the nacelle during discharge of the carbon dioxide extinguishing system were readily

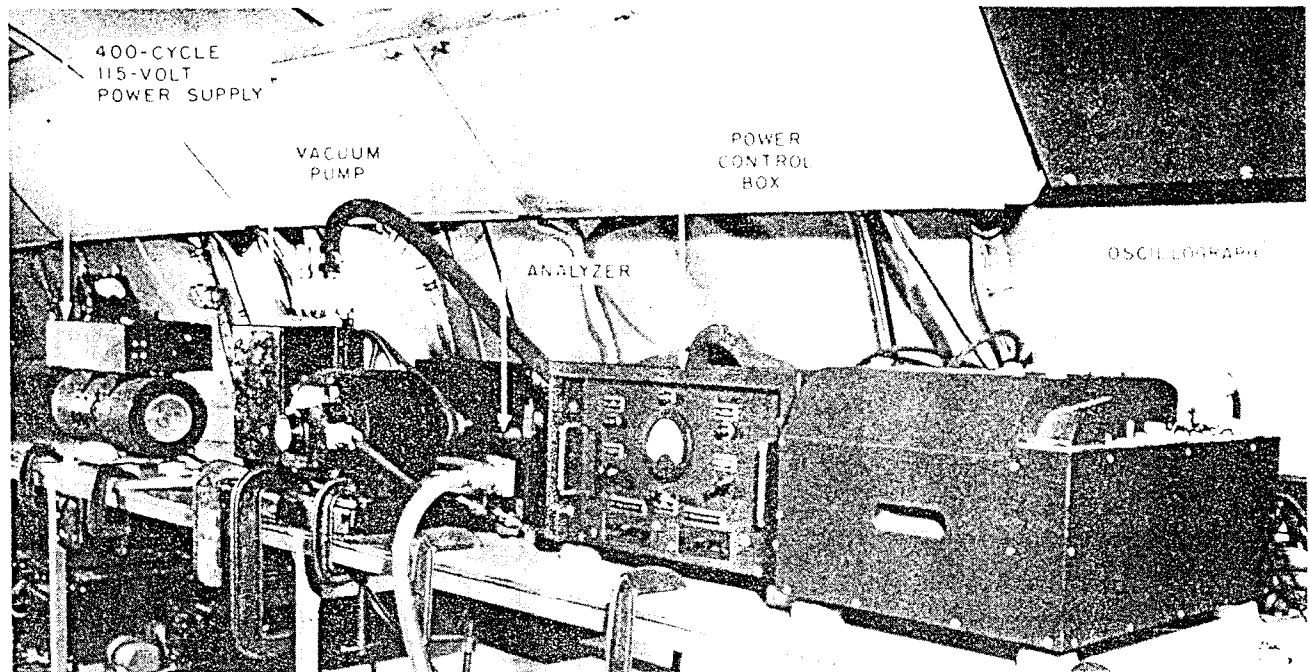

Fig. 13 Extinguishing-System Analyzer Mounted in DC-3 Airplane

and accurately obtained. Such curves permitted a thorough analysis and evaluation of the aircraft extinguishing system. The results of these tests will be discussed in detail separately in a forthcoming report covering the fire-testing of the B-45 power plant. However, the tests indicated that:

1. The analyzer provides a practical and effective method for the evaluation of aircraft extinguishing systems in test-cell studies.

2. The principle weakness of the analyzer is in the transducers, failures of which are apparently due to vibration loads imposed on the fine wires of the electric circuit. Such failures were infrequent, however.

Flight Tests.

The analyzer was flight-tested to determine the effect of normal flight vibrations on the instrument recordings. These tests were conducted by breadboard mounting of the various instrument components in a DC-3 airplane, as shown in Fig. 13. Records were made for air only during normal cruising and during a power-off glide.

A comparison of the records obtained in flight with those obtained in the test cell (B-45 tests) indicated that vibration effects were less in flight than during the ground tests. The instrument performed satisfactorily in every respect under flight conditions.

CONCLUSIONS

1. The Model GA-1 analyzer is a practical flight instrument, the use of which provides an effective means for analyzing and evaluating aircraft carbon dioxide fire-extinguishing systems.

2. In using the Model GA-1, Serial 1 analyzer, the calibration ratios determined by calibration tests should be used rather than the theoretically calculated values.

3. Successful utilization of the analyzer depends considerably on the skill of the operators who have familiarized themselves with the characteristics of the instrument. The proper interpretation of data also requires a background of experience with the instrument.

RECOMMENDATIONS

On the basis of the tests conducted, it is recommended that:

1. The GA-1 analyzer should be used in future analyses and evaluations of carbon dioxide fire-extinguishing systems in aircraft.

2. Controlled laboratory tests should be conducted with the GA-1 analyzer to determine its accuracy and dependability with the agents methyl bromide and bromochloromethane.

3. The GA-1 analyzer should be used in conjunction with future fire testing on full-scale aircraft power plants. Such use will provide an effective test method for securing data helpful to the interpretation of analyzer recordings.

4. The GA-1 analyzer should be operated

only by personnel who have received adequate instruction in its operation.

5. In its present stage of development, the analyzer should only be used on aircraft by personnel experienced in its operation and in aircraft fire testing.