

PERFORMANCE OF A DC-9 AIRCRAFT LIQUID NITROGEN FUEL TANK INERTING SYSTEM

**E. P. Klueg
W. C. McAdoo
W. E. Neese**

**National Aviation Facilities Experimental Center
Atlantic City, New Jersey 08405**



AUGUST 1972

FINAL REPORT

Availability is unlimited. Document may be released to the National Technical Information Service, Springfield, Virginia 22151, for sale to the public.

Prepared for

**DEPARTMENT OF TRANSPORTATION
FEDERAL AVIATION ADMINISTRATION**

Systems Research & Development Service

Washington D. C., 20591

1. Report No. FAA-RD-72-53		2. Government Accession No.		3. Recipient's Catalog No.	
4. Title and Subtitle PERFORMANCE OF A DC-9 AIRCRAFT LIQUID NITROGEN FUEL TANK INERTING SYSTEM				5. Report Date August 1972	
				6. Performing Organization Code	
7. Author(s) E. P. Klueg W. C. McAdoo W. E. Neese				8. Performing Organization Report No. FAA-NA-72-38	
9. Performing Organization Name and Address National Aviation Facilities Experimental Center Atlantic City, New Jersey 08405				10. Work Unit No.	
				11. Contract or Grant No. Project No. 184-733-01X	
				13. Type of Report and Period Covered Final April 1971 - March 1972	
12. Sponsoring Agency Name and Address FEDERAL AVIATION ADMINISTRATION Systems Research and Development Service Washington, D.C. 20591				14. Sponsoring Agency Code	
15. Supplementary Notes					
16. Abstract Nitrogen inerting protection for the fuel systems in commercial aircraft has been proposed to reduce fire and explosion hazards associated with refueling, electrical and mechanical failures, engine failures, in-flight fires, lightning strikes, and survivable crashes. A liquid nitrogen fuel tank inerting system was developed and installed on an FAA DC-9-15 aircraft. Instrumentation equipment and measurement techniques for evaluating the installed fuel tank inerting system performance were developed. A flight test program was conducted to demonstrate compliance of the DC-9 inerting system with applicable airworthiness standards, to evaluate oxygen concentration measurement techniques, and to verify that the installed inerting system maintained an explosion safe mixture in the fuel tanks over the entire flight envelope. Oxygen concentrations at various locations of the ullage and vent systems and the operating characteristics of the inerting system were determined during the flight test program. The inerting system was determined to be capable of maintaining a mixture in the fuel system vents and tank vapor spaces having a volumetric oxygen concentration less than 8 percent under all normal and emergency flight conditions. The in-flight oxygen analyzer equipment and the measurement techniques utilized provided the oxygen concentration information required to evaluate the performance of the inerting system. Oxygen concentration measurements in each enclosed vapor space, under critical fueling and flight conditions, and in each vent system throughout each test flight were required.					
17. Key Words Aircraft, Aircraft Fires, Aviation Safety, Controlled Atmospheres, Cryogenics, Fire Safety, Fuel Systems, Fuel Tanks, Ignition, Jet Transport Planes, Nitrogen, Tank Vents			18. Distribution Statement Availability is unlimited. Document may be released to the National Technical Information Service, Springfield, Virginia 22151, for sale to the public.		
19. Security Classif. (of this report) Unclassified		20. Security Classif. (of this page) Unclassified		21. No. of Pages 74	22. Price \$3.00 PC .95 MF

TABLE OF CONTENTS

	Page
INTRODUCTION	1
Purpose	1
Background	1
DISCUSSION	1
DC-9-15 Aircraft Design Changes and Fuel System Description	1
Fuel Tank Nitrogen Inerting System Description	4
Nitrogen Supply Subsystem	6
Scrub Subsystem	6
Pressurization Subsystem	8
Servicing and Checkout Subsystem	8
System Operation	11
Aircraft Servicing with Liquid Nitrogen	12
Test Instrumentation	13
Flight Test Program	17
Nitrogen Inerting System Performance	17
Stratification and Mixing	61
Oxygen Sampling Requirements	64
SUMMARY OF RESULTS	66
CONCLUSIONS	68
REFERENCES	69

LIST OF ILLUSTRATIONS

Figure		Page
1	Fuel Tank and Vent System	3
2	Nitrogen Scrub Subsystem	5
3	Nitrogen Supply Subsystem	7
4	Nitrogen Pressurization Subsystem	9
5	Nitrogen Servicing and Checkout Subsystem	10
6	Fuel System Vapor Sample and Return Locations	14
7	Oxygen Concentration Instrumentation System	15
8	Flight Tests and Profiles	
	A. Flight No. 1	19
	B. Flight No. 2	20
	C. Flight No. 3	21
	D. Flight No. 4	22
	E. Flight No. 5	23
	F. Flight No. 6	24
	G. Flight No. 7	25
	H. Flight No. 8	26
	I. Flight No. 9	27
	J. Flight No. 10	28
	K. Flight No. 11	29
	L. Flight No. 12	30
9	Oxygen Concentrations in Left Main Fuel System for Flight 1	34
10	Oxygen Concentrations in Center Fuel Tank for Flight 1	35
11	Oxygen Concentrations in Right Main Fuel System for Flight 1	36
12	Oxygen Concentrations in Center Fuel Tank for Flight 2	37
13	Oxygen Concentrations in Right Main Fuel System for Flight 2	38
14	Oxygen Concentrations in Left Main Fuel System for Flight 3	41

LIST OF ILLUSTRATIONS (continued)

Figure		Page
15	Oxygen Concentrations in Center Fuel Tank for Flight 3	42
16	Oxygen Concentrations in Right Main Fuel System for Flight 3	43
17	Oxygen Concentrations in Left Main Fuel System for Flight 4	45
18	Oxygen Concentrations in Center Fuel Tank for Flight 4	46
19	Oxygen Concentrations in Right Main Fuel System for Flight 4	47
20	Oxygen Concentrations in Left Main Fuel System for Flight 6	48
21	Oxygen Concentrations in Center Fuel Tank for Flight 6	50
22	Oxygen Concentrations in Right Main Fuel System for Flight 6	51
23	Oxygen Concentrations in Left Main Fuel System for Flight 7	53
24	Oxygen Concentrations in Center Fuel Tank for Flight 7	54
25	Oxygen Concentrations in Right Main Fuel System for Flight 7	55
26	Oxygen Concentrations in Left Main Fuel System for Flights 8 and 9	57
27	Oxygen Concentrations in Center Fuel Tank for Flights 8 and 9	58
28	Oxygen Concentrations in Right Main Fuel System for Flights 8 and 9	59

LIST OF TABLES

Table		Page
1	Aircraft Configuration and Flight Test Description	18
2	Summary of Oxygen Concentration Measurements	31

INTRODUCTION

Purpose

This report presents the results of a program directed toward (1) the development of a liquid nitrogen fuel tank inerting system for a jet transport aircraft, (2) the evaluation of the functional and performance characteristics of the system, and (3) the development of instrumentation equipment and techniques for evaluating the installed fuel tank inerting system performance.

Background

Nitrogen inerting systems have been tested on the B-70, C-141, and C-135 military aircraft and installed as a production system on the SR-71 aircraft to inert the fuel system and prevent ignition in the fuel tanks. Adoption of fire protection for fuel systems in commercial aircraft is being proposed to reduce fire and explosive hazards associated with refueling, electrical and mechanical failures, engine failures, in-flight fires, lightning strikes and survivable crashes. Nitrogen inerting is considered to be a promising approach for this purpose.

On September 26, 1969, Flight Standards Service (FS) issued Request No. FS-100-70-105 for a research, development, and evaluation effort to develop and certificate a liquid nitrogen (LN₂) fuel tank inerting system for a jet transport aircraft. A project was initiated by the Systems Research and Development Service (SRDS) in October 1969 to develop, install, and flight test an inerting system on the FAA DC-9-15 jet transport aircraft. In May 1970, Contract DOT-FA70WA-2334 was awarded to the Systems Division, Parker Hannifin Corporation, Irvine, California, for designing and manufacturing the inerting system and for installation in the DC-9 aircraft under subcontract to the Lockheed Aircraft Service Company, Ontario, California.

Flight Standards Service also issued a request (FS-100-70-107) on May 22, 1970, for information on the inerted fuel tank oxygen concentration measurement techniques. In response to this request, a project was initiated at the National Aviation Facilities Experimental Center (NAFEC) in August 1970, and testing in conjunction with the DC-9 Flight Test Program was completed in May 1971. This report covers the results of the work performed under these two projects during this flight test program.

DISCUSSION

DC-9-15 Aircraft Design Changes and Fuel System Description

Some aircraft design changes were necessary to permit the installation of the fuel tank inerting system. The most significant was the replacement of the vent box standpipes, with climb and dive valve assemblies, to permit pressurization of the fuel tanks. The inlet and outlet of the primary climb and dive valve assembly in the final configuration were the same as the location of the original standpipe.

The lower anticollision light mounting was altered. The light assembly was displaced downward by the insertion of a mount extension. This modification was necessary because the upper light housing projected above the aft baggage compartment floor, interfering with installation of the liquid nitrogen container.

The aircraft pneumatic system was tapped to supply air pressure for checkout and override operation of the inerting system climb and dive valves. The aircraft could be operated uninerted with the climb and dive valves open by opening the pneumatic crossfeed and the climb and dive override valves.

The DC-9-15 aircraft has three integral fuel tanks (left main, center, and right main) having a total usable capacity of approximately 3700 gallons. The installation of the inerting system components in the fuel tanks resulted in the reduction of usable fuel by an estimated 8 gallons. The inboard end of each main tank acts as a fuel reservoir (fuel feed box) with flapper-type baffles (Figure 1) to maintain a fuel head at the boost pumps during all normal aircraft attitudes and maneuvers. Each main tank has two boost pumps installed in the fuel feed box for that tank. Two boost pumps for the center tank are enclosed in a can which is located in the right main tank to facilitate access. An engine start pump is also installed in the right main tank for auxiliary power unit or engine starting from the aircraft batteries.

The right and left main tank-to-engine feed lines are interconnected by a fuel crossfeed line and a crossfeed valve. Turning on one or more fuel boost pumps will supply fuel to the fuel distribution system. With the fuel crossfeed valve closed, fuel from the center tank will go to the entire distribution system; fuel from the left main tank will go to the left engine; and fuel from the right main tank will go to the right engine and the auxiliary power unit. Opening the fuel crossfeed valve allows any pump to supply any part of the fuel distribution system.

After takeoff and initial climb, the normal fuel schedule required feeding both engines from the center tank until the tank was emptied. The left and right engines were then operated with fuel from the left and right main tanks, respectively.

As shown in Figure 1, each main tank was vented through piping to a vent box located in the opposite wingtip. This vent system arrangement was designed to prevent spillage caused by low-wing dihedral in conjunction with taxi sloshing or adverse ground and flight attitudes. Internally, each main tank has two vent outlets, an open bellmouth fitting outboard and a floatvent valve at a forward inbound location. The bellmouth fitting is always open while the floatvent valve opens only when the aircraft is in a climb attitude or the fuel level is below the float. Float drain valves permit fuel in a vent line to drain into a main tank when the fuel level in the vent line is 1 inch above the fuel

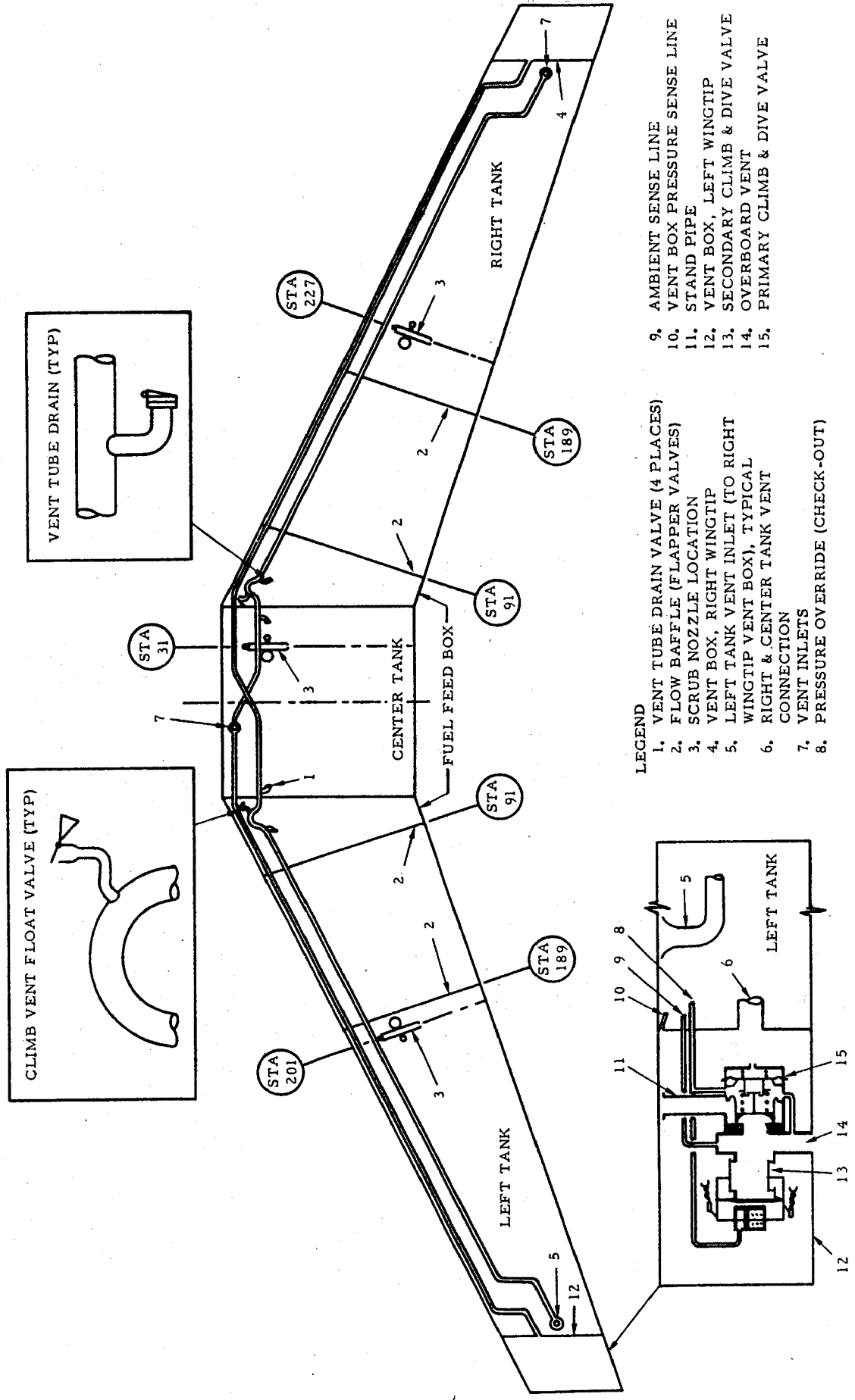

FIGURE 1 - FUEL TANK AND VENT SYSTEM

level in the tank. The center tank is vented to the left wingtip vent box through an open bellmouth fitting in the forward center portion of the tank. The fitting is connected to the crossover vent line for the right main tank which runs to the left wingtip vent box. The vent lines were sized to flow fuel overboard at maximum fill system pressure with one tank receiving fuel.

All tank fueling can be accomplished from a single-point pressure fueling station. There are two tank fill control float switches in each main tank and one in the center tank. These float switches automatically close the fueling valves when the tank becomes full. This allows 33.5 gallons of expansion space in each main tank and 19.5 gallons in the center tank. The fueling outlets in each tank were modified during the installation of the nitrogen inerting system to incorporate scrub nozzles (Figure 2).

The aircraft fuel tank vent system was modified prior to Flight 6 by the installation described in Douglas Aircraft Service Bulletin No. 28-21. The service bulletin incorporated new spring-loaded, flapper-type vent drain valves (Figure 1) to replace the float-type vent drain valves. One vent drain valve in each vent line was relocated from the main tanks to permit drainage of the vent pipe into the center tank which is normally emptied first. The inerting system design was based on the vent pipes being clear of fuel. The original float-type drain valves were determined not to be seating properly and allowing fuel to be vented overboard during Flight 4.

Standard aircraft practices were observed during inerting system installation in regard to structural members, brackets, clips, anchorages, etc.

Fuel Tank Nitrogen Inerting System Description

The inerting system installed in the FAA DC-9 aircraft was designed to render the air/fuel vapor mixture in the fuel system vents and tank vapor spaces nonreactive by replacing the oxygen in the mixture with nitrogen in sufficient measure to maintain a volumetric oxygen concentration of 9 percent or less. Reference 1 concludes that maintaining a 9 percent oxygen content prevents ignition and flame propagation with mixture temperatures below 550°F at sea-level pressure. Nitrogen gas is supplied from the liquid nitrogen vacuum-insulated storage vessel, or Dewar, located in the forward portion of the aft baggage compartment. In order to contain the nitrogen-rich atmosphere within the fuel tanks and vent system, the vent outlets in either wingtip were replaced with differential pressure-actuated climb and dive valves within the existing vent boxes. A positive pressure of about 0.5 psid (pounds per square inch differential) is maintained in the tanks under normal flight and ground conditions.

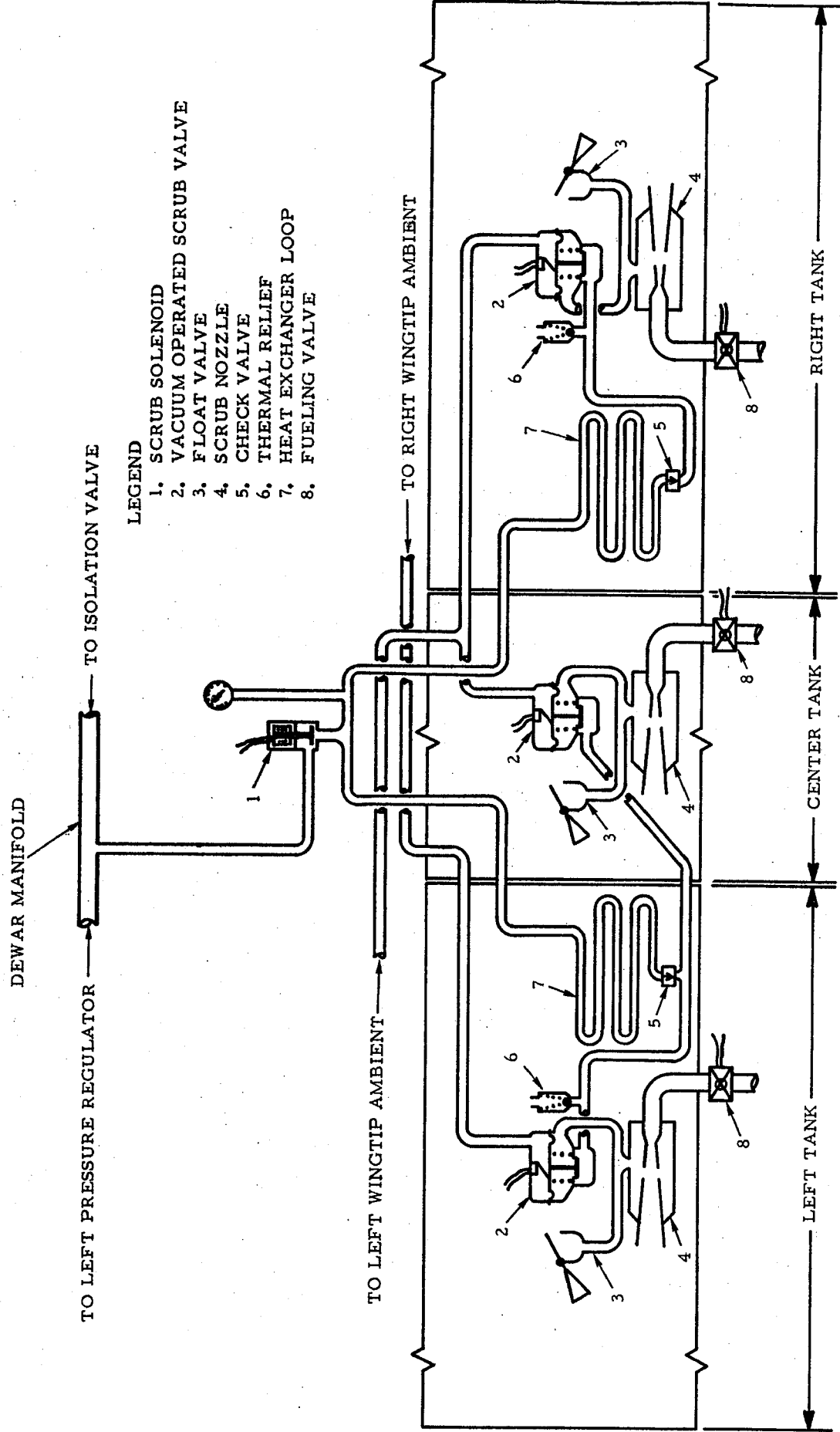

LEGEND

- 1. SCRUB SOLENOID
- 2. VACUUM OPERATED SCRUB VALVE
- 3. FLOAT VALVE
- 4. SCRUB NOZZLE
- 5. CHECK VALVE
- 6. THERMAL RELIEF
- 7. HEAT EXCHANGER LOOP
- 8. FUELING VALVE

FIGURE 2 - NITROGEN SCRUB SUBSYSTEM

Since jet fuels dissolve large amounts of air during normal handling and storage, and this air comes out of solution when atmospheric pressure is reduced, as during climb, the inert tank vapor spaces become contaminated with the oxygen-rich air which evolves from the fuel during the initial climb. In order to minimize the amount of air released from the fuel during climb, air is scrubbed from the fuel during the fueling operation by the onboard scrub subsystem which ejects nitrogen supplied from the vapor space and the Dewar into the incoming fuel and forces oxygen out of solution.

The inerting system consists of four subsystems:

- Nitrogen supply subsystem
- Scrub subsystem
- Pressurization subsystem
- Servicing and checkout subsystem

Each subsystem will be discussed individually.

Nitrogen Supply Subsystem: The nitrogen supply subsystem, shown in Figure 3, stores liquid nitrogen saturated at 45 psig and -295°F and supplies nitrogen to the scrub subsystem and the pressurization subsystem. It consists of a Dewar with a capacity of 270 pounds of liquid nitrogen, a distribution manifold, a back pressure relief valve to prevent overpressurization of the Dewar, an isolation valve to prevent fuel from flowing into the Dewar as when the LN₂ supply is depleted, and a pressure limiter to limit the outflow pressure from the Dewar to a safe value to prevent overpressurizing the fuel tanks. The Dewar is fitted with a burst disc and a blowout plug to guard against rupture of either the inner or outer shells. Since the baggage compartment is pressurized, any relieved nitrogen is dumped overboard through piping out the bottom of the fuselage. An indication of Dewar quantity is provided at the service panel and on the cockpit annunciator light panel. The Dewar "full" light at the service panel is on when the Dewar is full and goes off when the level is below full. The Dewar "one-third full" light at the service panel is on when the LN₂ quantity in the Dewar is above one-third full. The Dewar "low" light in the cockpit comes on when the LN₂ quantity in the Dewar falls below one-third full.

Scrub Subsystem: The scrub subsystem, shown in Figure 2, removes oxygen from the fuel during refueling by an automatic process called "aspiscrubbing." The scrub subsystem consists of an ejector located in each tank which ejects nitrogen into the fuel, a scrub solenoid, and a scrub shutoff valve for each of the three tanks to supply gaseous nitrogen on demand to the mixing section of the ejectors. There are four indicator lights on the service panel which indicate proper scrubbing operation. These lights are latching lights and remain on after refueling until reset. Three of the lights illuminate upon the actuation of the scrub shutoff valves and the other illuminates upon actuation of the scrub solenoid. All four lights should be on at the completion of fueling to indicate completion of the scrub cycle.

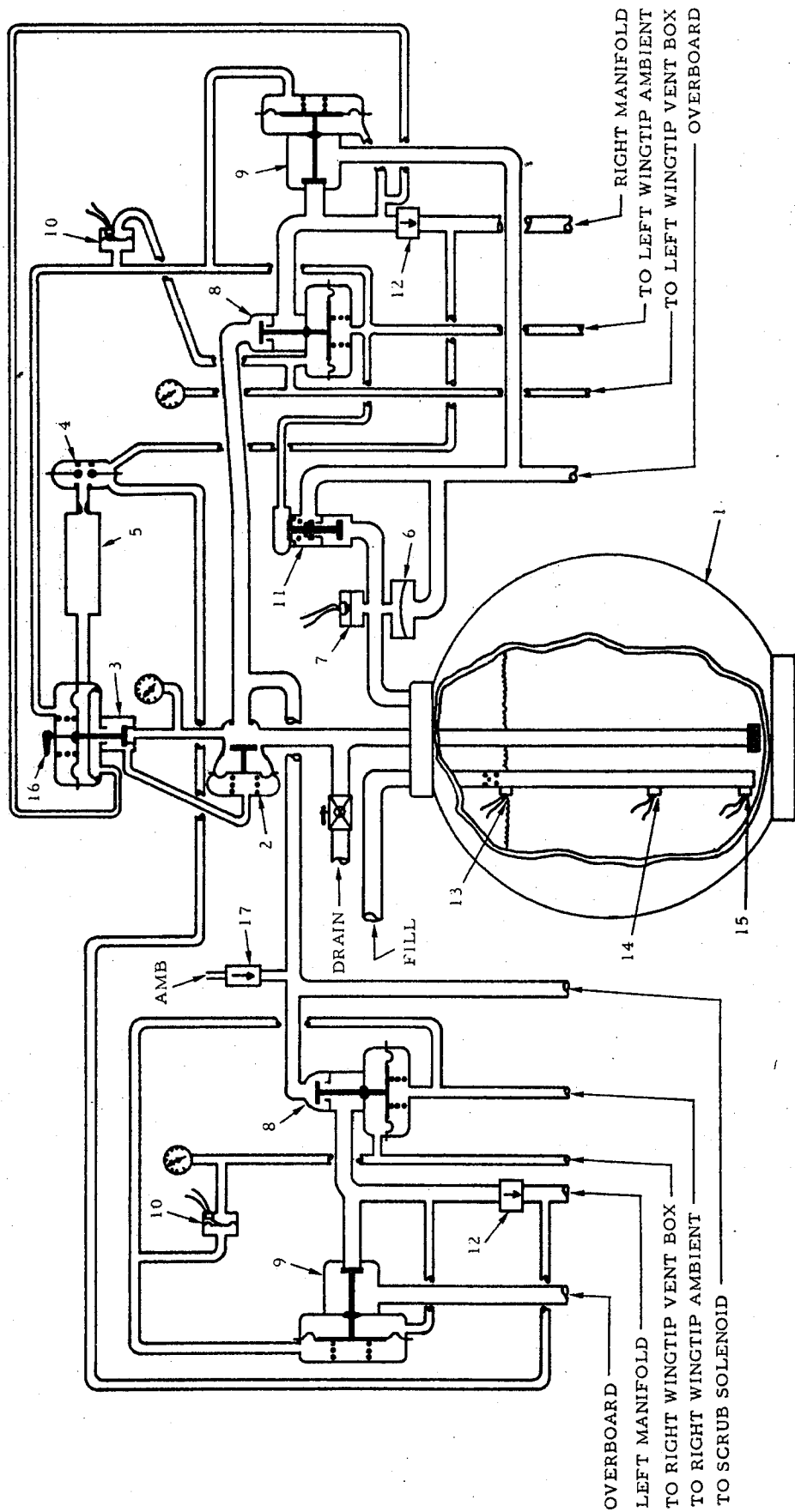

LEGEND

- 1. DEWAR (LN₂ STORAGE)
- 2. ISOLATION VALVE
- 3. PRESSURE LIMITER
- 4. PRIORITY VALVE
- 5. SURGE CHAMBER & ORIFICE
- 6. SAFETY DISC
- 7. N₂ PRESSURE SWITCH
- 8. PRESSURE REGULATOR
- 9. OVERBOARD RELIEF VALVE
- 10. NEGATIVE TANK PRESSURE SWITCH
- 11. BACK PRESSURE RELIEF VALVE
- 12. CHECK VALVE
- 13. FULL LEVEL SENSOR
- 14. 1/3 FULL SENSOR
- 15. SERVICE UNIT LOGIC
- 16. MANUAL OVERRIDE
- 17. BREAKER VALVE (VACUUM)

FIGURE 3 - NITROGEN SUPPLY SUBSYSTEM

Pressurization Subsystem: The pressurization subsystem, shown in Figure 4, supplies nitrogen to the fuel tanks to maintain a positive pressure in the tanks and to exclude air from the tanks and vent system. The subsystem consists of a remote-sensing, direct-acting mechanical pressure regulator, shown in Figure 3, which regulates the fuel tank vapor space pressure using nitrogen as the pressurant; a priority valve which senses the right and left tank differential pressures and directs the higher of the two pressures to a control outlet port to insure against overpressurization of the fuel tanks; an overboard relief valve to vent overboard any excessive nitrogen which flows as a result of a failed open pressure regulator. A primary climb and dive valve (Figure 1) is located in each wingtip vent box which is direct actuating in either a positive or negative pressure direction and opens during climb to prevent overpressurization of the fuel tanks during normal operation and during descent or cruise in the event the pressurization system fails to supply sufficient nitrogen to prevent excessive negative tank pressure. As a backup measure to assure that allowable positive or negative tank pressures are not exceeded, a secondary climb valve and a secondary dive valve are located in each wingtip vent box. These valves are poppet actuated and are set to open at a slightly greater positive and negative tank/vent pressure than the primary valves but well within allowable tank pressure limits. Operational pressures of the main pressurization subsystem components were:

1. Pressure Regulators	0.5 psid
2. Primary Climb Valves	0.7 psid
3. Secondary Climb Valves	1.0 psid
4. Primary Dive Valves	-0.1 psid
5. Secondary Dive Valves	-0.2 psid

Servicing and Checkout Subsystem: The liquid nitrogen Dewar is serviced at the service panel, shown in Figure 5, inside the aft baggage compartment from a liquid nitrogen servicing truck which has a capacity of 100 gallons. Pressure building equipment is used in this prototype ground service unit to transfer the nitrogen, and a certain amount of nitrogen waste occurs. This waste could be reduced significantly by the use of a fill pump. When the Dewar is full, the Dewar full light on the service panel illuminates, and the flow of LN₂ from the servicing truck ceases. The fill connection, a simple quick disconnect for the flexible pipe from the servicing truck, is then broken and the flexible pipe stowed in the truck. The climb and dive valve preflight checkout valve pneumatically opens all climb and dive valves. Indicator lights are incorporated into the service panel to indicate: LN₂ quantity, actuation of scrub shutoff valves and scrub solenoid, and opening of climb and dive valves. An indicator light press-to-test switch and a switch to reset latching indicator lights are also located on the service panel. The pneumatic override valve holds all climb/dive valves open in the event of operation with an inoperative climb/dive valve. The nitrogen supply from the Dewar can be shut off by placing the pressure limiter handle in the "off" position for maintenance purposes or in the event the airplane will be flown not inerted. A signal conditioner is employed to amplify the output of thermistors in the Dewar in order to control the automatic fill and actuate the display lights.

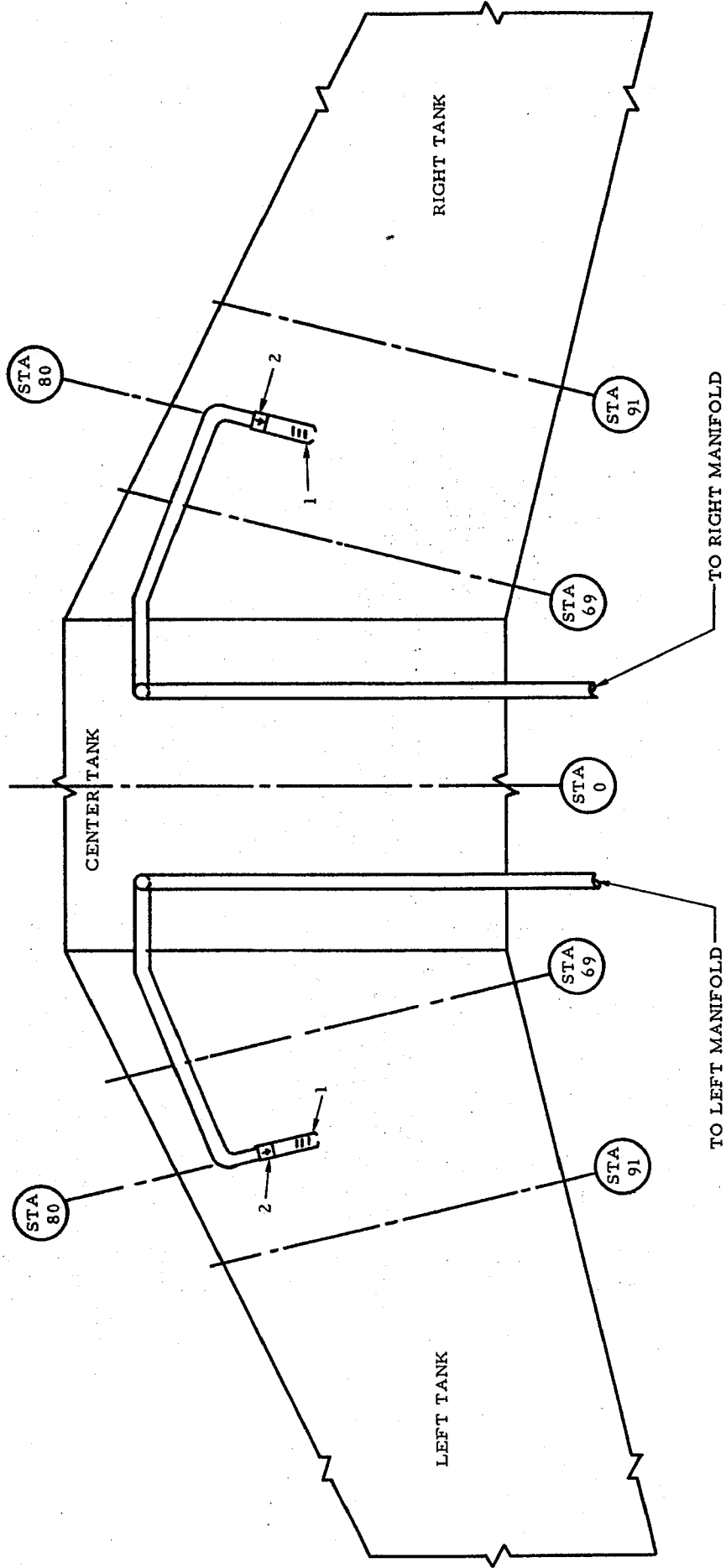

LEGEND
 1. FOG NOZZLE
 2. CHECK VALVE

FIGURE 4 - NITROGEN PRESSURIZATION SUBSYSTEM

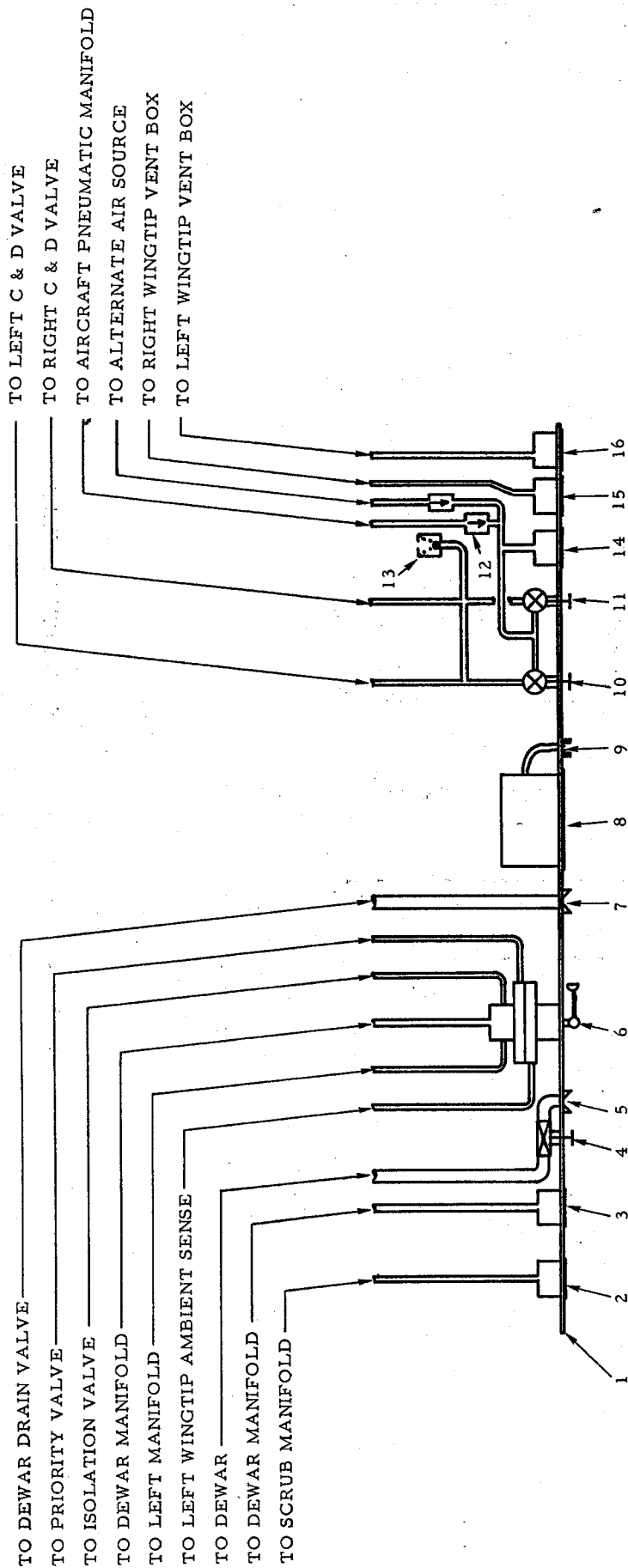

LEGEND

- | | |
|---|---|
| 1. SERVICE PANEL | 9. SERVICE UNIT ELECTRONIC CONNECTOR |
| 2. SCRUB MANIFOLD PRESS. | 10. CLIMB & DIVE CHECK-OUT VALVE (SPRING LOADED CLOSED) |
| 3. DEWAR PRESS. | 11. CLIMB & DIVE OVERRIDE VALVE (DETENTED) |
| 4. DEWAR FILL VALVE | 12. CHECK VALVE (TWO PLACES) |
| 5. DEWAR FILL CONN. | 13. RELIEF VALVE |
| 6. PRESSURE LIMITER VALVE | 14. OVERRIDE & CHECK-OUT MANIFOLD PRESSURE GAUGE |
| 7. DEWAR DRAIN CONN. | 15. LEFT TANK PRESSURE GAUGE |
| 8. SIGNAL CONDITIONER (RECEIVES ALL COMPONENT ELECTRONIC SIGNALS, SERVES COCKPIT ANNUNCIATOR, SERVICE PANEL ANNUNCIATOR, & SERVICE UNIT LOGIC). | 16. RIGHT TANK PRESSURE GAUGE |

FIGURE 5 - NITROGEN SERVICING AND CHECKOUT SUBSYSTEM

System Operation : System operation begins with the scrubbing of fuel as the airplane is refueled. If the tank vapor space is inert at the start of refueling, the scrub solenoid valve opens when the aircraft refueling power switch is "on," and an aircraft fueling valve opens, making nitrogen available to the scrub manifold from the Dewar. The tank scrub shutoff valves are closed at this point and nitrogen is taken from the tank vapor space by the ejectors and mixed with the incoming fuel for scrubbing. When the fuel level in the tank reaches approximately one-half full, a float valve closes off the top of the ejector, causes a vacuum at the scrub shutoff valve which causes the scrub shutoff valve to open, and allows nitrogen from the Dewar to enter the ejector and complete the scrubbing operation. The gases in the vapor space become contaminated with oxygen scrubbed from the fuel at about the one-half full level necessitating the use of pure nitrogen during the last half of the fueling operation. When fueling is stopped, the scrub shutoff valve closes as a vacuum is no longer generated. The scrub solenoid valve closes when the fueling valves are deenergized or the fueling power switch is returned to "off." If the aircraft fuel tanks are not inert at the start of fueling, proper scrubbing and tank inerting are obtained by fueling, defueling, and refueling, all with the inerting system operating.

There are two climb/dive valve indicator lights on the cockpit annunciator panel. One is connected to the primary dive valve position switches and to the fuel tank low pressure switch and will illuminate if either valve opens enough to complete the position switch circuit or if the tank pressure approaches zero. The second light is connected to both secondary climb valves and both secondary dive valves and will illuminate if any valve opens. During normal operation neither of these two lights should illuminate.

During climbout, the tank differential pressure builds up with an increase of aircraft altitude and is bled off through the primary climb/dive valves. There is no nitrogen flow into the tanks during a steady climb. After leveling off at altitude, the volume of fuel consumed by the engines is replaced by nitrogen from the pressurization system which maintains positive tank pressure. During descent, the pressurization system feeds nitrogen into the tanks to maintain positive tank pressure as the tank differential pressure tends to decrease with a decrease in aircraft altitude. Should the pressurization system fail to maintain a positive tank pressure for any reason, such as depletion of the nitrogen supply, a tank pressure sensing switch will actuate as the tank pressure approaches zero and illuminate the primary dive valve indicator light in the cockpit. This pressure switch will also illuminate the latching primary dive light on the service panel through a 10-second time delay relay. This time delay relay prevents momentary tank pressure losses from illuminating the service panel dive light when in actuality no outside air entered the tank. If the tank pressure goes negative during descent, the primary dive valve will open and admit air into the tank. If the valve travel is enough, the contact switch will illuminate both cockpit light and the service panel dive valve light. Should the primary valve fail to open, the secondary valve will open at a slightly greater negative pressure.

On the ground, the inerting system will maintain an inerted atmosphere in the tanks and vent system if left unattended without electrical power for as long as the nitrogen supply lasts. Normally, this is expected to be in excess of 24 hours and up to 3 weeks, provided the Dewar one-third full light was illuminated upon landing.

Aircraft Servicing with Liquid Nitrogen

Liquid nitrogen is stored in the service vehicle Dewar at a saturation pressure of about 15 psig. In order to transfer liquid nitrogen to the aircraft Dewar, a hand valve is closed which isolates the 15-psig relief valve and raises the service vehicle Dewar relief pressure to 125 psig. The service vehicle Dewar pressure is then raised to 100 psig by passing liquid nitrogen through a pressure buildup heat exchanger. The heat exchanger adds heat to the liquid nitrogen causing it to change to gaseous nitrogen. This gaseous nitrogen is then introduced at the top of the service vehicle Dewar to raise the pressure. The pressure buildup is regulated by a pressure switch and solenoid valve.

Saturation pressure of the nitrogen introduced into the aircraft Dewar is controlled by mixing warm gas with the liquid to raise its saturation pressure to the required value through a temperature control valve. Heat input is provided by a heat exchanger (the muffler of the service vehicle) and mixing is accomplished by an ejector.

Liquid nitrogen is transferred from the service vehicle to the aircraft Dewar automatically through a vacuum-jacketed hose. Integral with the hose is an electrical connector and cable which conveys sensor signals to the service unit. When the service unit Dewar pressure exceeds 100 psig, the servicing solenoid valve opens and liquid nitrogen is transferred. When the aircraft Dewar pressure exceeds 52 psig, automatic venting occurs. Alternate filling and venting continues until the aircraft Dewar is full, at which time an indicator light will illuminate and filling will stop automatically.

The fuel tank inerting system, shown in Figures 1 through 5, is the final system configuration. The system was modified between Flights 5 and 6. The original configuration had drain holes in the climb and dive valves and sensing chambers for vent box pressures. These drain holes and chambers were eliminated after Flight 5 and the vent box pressures were sensed directly from lines originating at the high point in each vent box. The scrub manifold and fog nozzle check valves, the service panel pressure gauges, check valve and fittings for checking out the climb and dive valves from an external pressure source, and the two negative tank pressure switches were incorporated into the system after Flight 5. The inlets to the primary climb and dive valves were raised after Flight 5 and relocated outboard at the position of the inlets of the original standpipes. At the same time,

the sense and nitrogen supply lines were rerouted and the check valves in the right and left nitrogen manifolds were reinstalled to prevent liquid from being trapped in the lines. Other items which were not incorporated into the system until after Flight 5 include: (1) drain valves in the sense and nitrogen supply lines, (2) liquid traps in sense lines at a location in the center tank with drain line connections to the wheel wells, (3) a pressure limiter with a narrower operating range to improve ground checkout performance, (4) sense line for priority valve relocated downstream of the check valves in the nitrogen manifolds, and (5) insulation on nitrogen supply lines under the cabin flooring.

The inerting system was also modified between Flights 6 and 7. A new pressure limiter was installed with a higher operating range. The primary purpose of this change was to increase the pressure setting at which the limiter opened, above the operating pressure of the regulators.

The empty inerting system installation weight, in the final system configuration, was 373 pounds. The Dewar capacity of 270 pounds of liquid nitrogen resulted in a total serviced system weight of 643 pounds. This weight is based on using, on the DC-9, a quantity of nitrogen and system components sized for large aircraft installation.

Test Instrumentation

Volumetric oxygen concentrations within the fuel tanks and vent systems were monitored and recorded throughout the DC-9 Flight Test Program. Figure 6 shows the eight probe locations selected for drawing off samples for analysis and the sample return location in each tank. The sample flows were returned to the fuel tanks so that nitrogen from the inerting system would not replace the vapor samples and produce abnormally low oxygen concentrations. As shown in Figure 7, vapor sample flows could be selected and continuously and simultaneously pumped from three of the eight sample probes. Samples 1 and 2 were normally selected for analysis through the first analyzing network, Samples 3, 4, and 5 through the second network, and 6, 7 and 8 through the third network. Samples 3 and 5 could be analyzed in the first and third networks, respectively, through proper selection of the sample inlet solenoid valves. The oxygen concentration in each of the three vapor streams could be measured continuously by the in-flight oxygen analyzers and periodically by an airborne mass spectrometer and by post-flight laboratory analysis of samples trapped in small volume cylinders. The in-flight oxygen analyzers directed 100 cm³/min. of the sample vapor, regulated at 19 psia, through a modified Beckman Model 715 Process Oxygen Sensor. The sensor measures the volumetric oxygen concentration by the diffusion of oxygen through a gas permeable membrane and an electrochemical reaction producing a current flow proportional to the partial pressure of the oxygen in the sample stream. The electrical output signal from each sensor was amplified and read directly in volumetric percentages on meters and recorded on a

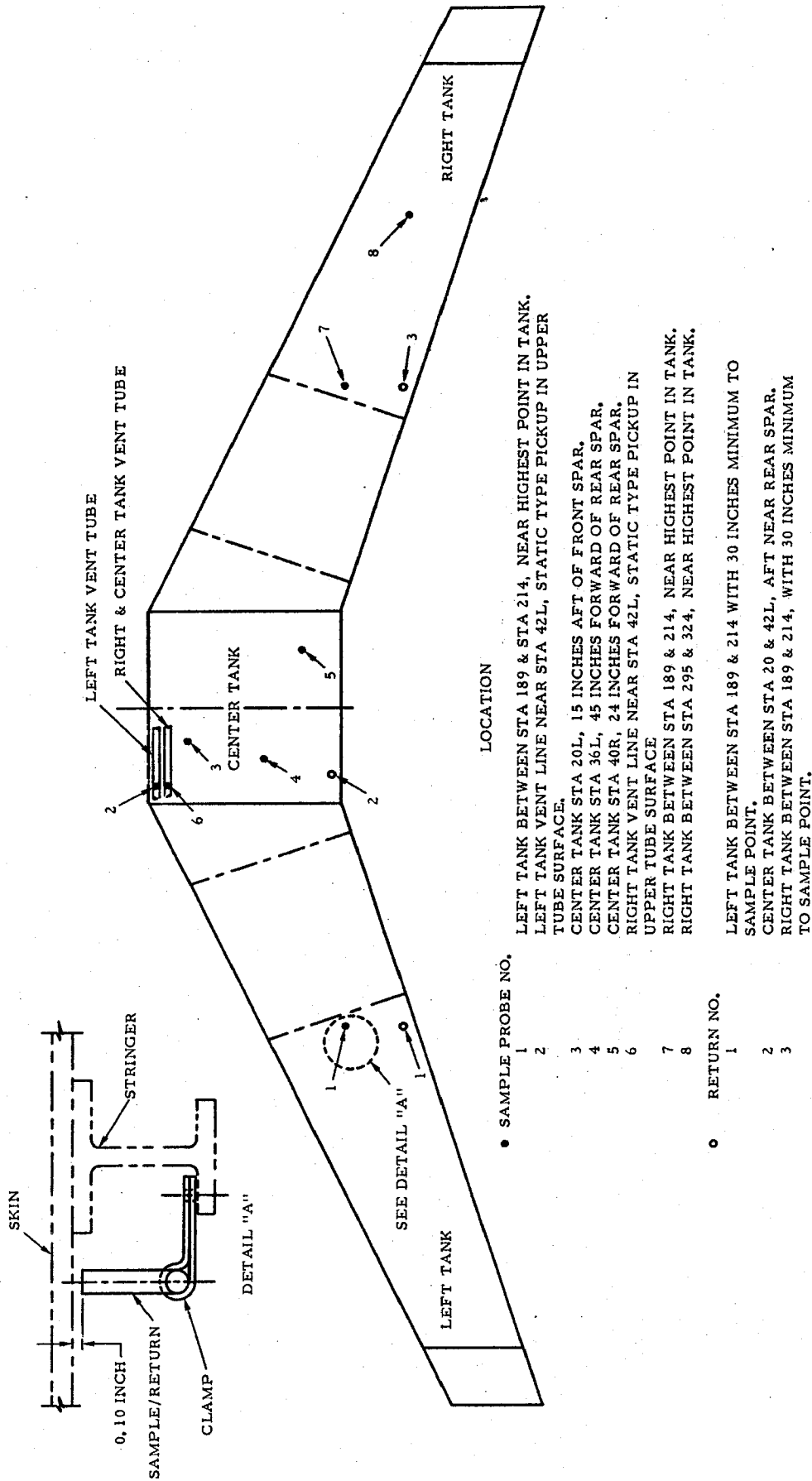

FIGURE 6 - FUEL SYSTEM VAPOR SAMPLE AND RETURN LOCATIONS

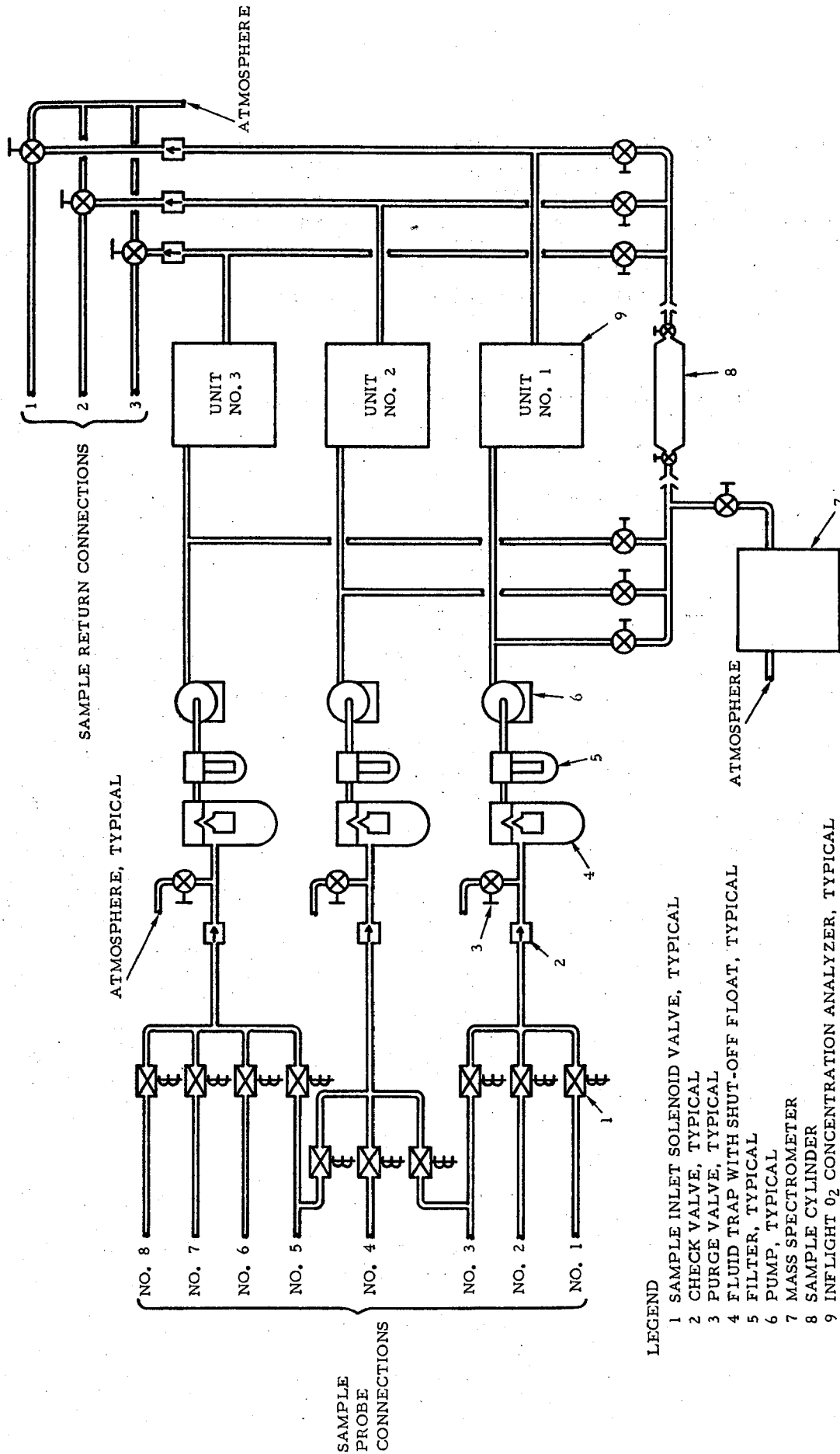

FIGURE 7 - OXYGEN CONCENTRATION INSTRUMENTATION SYSTEM

strip-chart recorder. The airborne mass spectrometer was a modified Aero Vac Model 370 with a Model 610 Controller. This equipment was on loan from the USAF, Wright-Patterson AFB, Ohio, and was capable of measuring and recording the oxygen concentrations of samples taken from one of the three vapor streams. The sampling system was designed so that cylinders could be inserted and 150 cm³ samples taken from the three vapor streams. The samples were then analyzed for volumetric oxygen concentration by a private laboratory using a Hitachi Perkin-Elmer Model RDU-6D mass spectrometer.

The sample locations were selected to provide oxygen concentration data on the following: (1) all three fuel tanks and both vent systems, (2) locations expected to have high concentrations under critical conditions, and (3) the degree of heterogeneous mixing in the fuel tank vapor space. Probes 2 and 6 in the vent line were located to determine critical oxygen concentrations during venting and to sense leakage of vent box climb or dive valves during descent. The maximum oxygen concentrations in the vent systems were expected to occur during or following a climb when the expanding vapors and the gases dissolved in the fuel are released through the vents. The vapors enter the vent pipes during a climb through the vent inlets, located outboard in each main tank, and the climb vent float valves, located inboard in each main tank. The locations of the vent line probes were selected to sense the combined oxygen concentration of the vapors entering the vent lines from both ends of each main tank. In the case of the center tank, vapors entered the right main tank vent system through the center tank vent inlet. The probe in the right vent line was located between the vent box and the center tank vent inlet and, therefore, was influenced by the oxygen concentration of the vapors entering the vent from the center tank. The vent line probes were also located to sense vent box valve leakage and the opening of a dive valve during level flight or a descent. The probe in the right main tank vent line was sensitive to air entering the vent since it was not in the pressurizing flow path of nitrogen from the right main tank to the center tank.

The location of the vapor spaces in the main tanks was expected to depend primarily on the aircraft attitude and to move between the wingtip and root with the tanks full or near full, due to the small dihedral angle and large sweep angle of the DC-9 wings.

A probe was located in the left main tank approximately midway between the two vent line openings and outboard of the fuel flow baffles. This location was selected to determine the oxygen concentration in the tank and the degree of mixing by comparison between oxygen concentrations in the vent and in the tank at a location remote to the vent inlets.

The three probes in the center tank were separated by ribs, and provided coverage of the immediate and remote areas relative to the vent inlet. These probes and the two probes in the right main tank were intended to measure the oxygen level and the degree of mixing in the center and right main tanks.

In addition to the oxygen level sensing instrumentation, differential pressure transducers and thermocouples were installed on the aircraft to measure vent box differential pressures and vapor, fuel and structural tank temperatures near the left nitrogen pressurizing nozzle.

Flight Test Program

A purpose of the DC-9 Flight Test Program was to demonstrate that the installed inerting system and modifications to the aircraft were in compliance with the applicable airworthiness standards of the Civil Air Regulations, Part 4b, for transport category aircraft and to obtain a no-hazard approval of the system with the issuance of a "one airplane only" supplemental type certificate. Another purpose of the flight test program was to evaluate oxygen concentration measurement techniques and to verify that the installed inerting system maintained an explosion-safe mixture in the fuel tanks over the entire flight envelope. The program was required to demonstrate that the inerting system did not adversely affect the operational capabilities of the aircraft or safety of flight, whether or not the system was operating. The flight and ground tests were therefore designed to check critical conditions from the standpoint of both the effects on the fuel system operating capabilities and the performance of the inerting system. Test items checked included engine accelerations and relights, fuel system crossfeed operations, taxi and in-flight maneuvers for fuel tank venting, and vent valves and nitrogen pressurization system performance under maximum rate climb and descent conditions with critical fuel loads. The checks were made with the Dewar isolation valve closed and the climb and dive valves both pneumatically opened and operating normally; the isolation valve open and with a supply of nitrogen in the Dewar ranging from full to a quantity which was depleted in flight; and initial fuel quantities ranging from 58 percent full to normal plus expansion space full. The purpose and conditions of the individual flight tests are presented in Table 1. The test items and flight profiles for each test flight are shown in Figures 8A through 8L. The aircraft was operated on aviation turbine fuel, type A, throughout the flight test program.

Nitrogen Inerting System Performance

The fuel tank oxygen concentration measurements are presented in Figures 9 through 28 and Table 2. The comparisons presented in Table 2 of the oxygen concentration analysis by the in-flight oxygen analyzer, the airborne mass spectrometer sampling, and the laboratory analysis of the samples taken in flight, show reasonably good agreement. The in-flight oxygen analyzer volumetric oxygen concentration measurements averaged 1/2 and 1 1/2 percent above the airborne and laboratory mass spectrometer measurements, respectively. Since the in-flight oxygen analyzer generally indicated higher oxygen concentrations and provided more extensive information, the in-flight oxygen analyzer data was considered to be conservative and was primarily used in this report to evaluate the performance of the inerting system. The airborne mass spectrometer analysis was discontinued after Flight 5 with the removal of the equipment from the aircraft. All sampling from the fuel and vent systems was discontinued after Flight 9, since the remaining flights did not require oxygen concentration measurements.

TABLE 1 - AIRCRAFT CONFIGURATION AND FLIGHT TEST DESCRIPTION

TEST FLIGHT NO.	DATE	FLIGHT TIME	FUEL LOAD	FUEL CONDITION	INERTING SYSTEM	PURPOSE OF FLIGHT	FUEL MANAGEMENT SCHEDULE (TIME POST)	
							CENTER FUEL TANK	MAIN FUEL TANKS
1	4-20-71	1312 1548	NORMAL FULL	PARTIALLY SCRUBBED	ISOLATION VALVE CLOSED C & D VALVES OPEN	1. Production test flight. 2. Check test instrumentation & modifications to aircraft with inerting system inoperative. 3. Determine effect of inoperative inerting system on aircraft operation. 4. Measure O ₂ concentration during ascent & release of dissolved gas from fuel.	13:14 to 14:00	14:00 to 15:48
2	4-22-71	0845 1222	MAXIMUM (1)	UNSCRUBBED	ISOLATION VALVE CLOSED C & D VALVES OPERATING	1. Demonstrate that C & D valves do not adversely affect fuel vent system and aircraft operation. 2. Check test instrumentation & aircraft modification with C & D valves operative. 3. Determine effect of shutting off or expending Nitrogen supply on aircraft operation. 4. Measure O ₂ concentration during ascent & release of dissolved gas from fuel.	08:45 to 09:19 09:13 to 10:36 10:36 to 10:56	09:19 to 09:28 09:13 to 10:36 10:56 to 12:22
3	4-22-71	1639 1803	70% NORMAL FULL	SCRUBBED	NORMAL OPERATION	1. Check aircraft modifications with inerting system operative. 2. Determine effect of operative inerting system on aircraft operation. 3. Evaluate performance of inerting system.	16:38 to 17:03	17:03 to 18:03
4	4-23-71	1116 1325	NORMAL FULL	SCRUBBED	NORMAL OPERATION	1. Check conditions causing fuel venting. 2. Evaluate performance of inerting system with step climb and descent procedures.	12:46 to 13:25	11:15 to 12:46
5	4-23-71	1649 1758	MAXIMUM (1)	PARTIALLY SCRUBBED	ISOLATION VALVE CLOSED C & D VALVES OPEN	1. Check for fuel venting with C & D valves open and inoperative inerting system.	16:44 to 17:58	16:44 to 17:58
6	5-27-71	1139 1319	NORMAL FULL	PARTIALLY SCRUBBED (2)	NORMAL OPERATION	1. Determine effect of operative inerting system as modified on fuel venting and aircraft operation. 2. Evaluate performance of modified inerting system.	11:32 to 12:27	12:27 to 13:19 (3)
7	5-29-71	0945 1220	NORMAL FULL	SCRUBBED	NORMAL OPERATION	1. Determine effect of operative inerting system as modified on fuel venting and aircraft operation. 2. Evaluate performance of modified inerting system under critical conditions for O ₂ concentrations.	09:41 to 10:39	10:39 to 11:04 (4) 11:04 to 12:20
8	5-29-71	1516 1655	MAXIMUM (1)	SCRUBBED	NORMAL OPERATION	1. Determine effect of operative inerting system as modified on fuel venting and aircraft operation. 2. Evaluate performance of modified inerting system.	15:09 to 16:08 16:36 to 16:39 16:42 to 16:43	16:08 to 16:36 16:39 to 16:42 16:43 to 16:55
9	5-29-71	1700 1749	58% NORMAL FULL	SCRUBBED	NORMAL OPERATION	1. Determine effect of operative inerting system as modified on fuel venting and aircraft operation. 2. Evaluate performance of modified inerting system.	17:01 to 17:03	17:03 to 17:47
10	5-30-71	0925 1050	MAXIMUM (1)	PARTIALLY SCRUBBED	INITIAL NORMAL OPERATION WITH SMALL SUPPLY OF LN ₂	1. Determine effect of operative inerting system as modified on fuel venting and aircraft operation when the nitrogen supply is depleted during flight.	09:16 to 09:51 10:06 to 10:50	09:51 to 10:06
11	5-30-71	1432 1903	MAXIMUM (1)	PARTIALLY SCRUBBED	NORMAL OPERATION	1. Check modifications to aircraft and conditions causing fuel venting with modified inerting system operating.	NO DATA	NO DATA
12	5-30-71	1951 2015	MAXIMUM (1)	UNSCRUBBED	ISOLATION VALVE CLOSED C & D VALVES OPEN	1. Check for fuel venting with C & D valves open and inoperative inerting system.	NO DATA	NO DATA

(1) Normal full plus expansion space (33.5 gallons each main and 19.5 gallons center tank).
 (2) Vent boxes opened after scrubbing exposing fuel to air and allowing nitrogen flow for repressurization.
 (3) 12:36 to 12:44 and 12:51 to 12:56 both engines operated on fuel from left tank. 12:44 to 12:51 both engines operated on fuel from right tank.
 (4) Left main tank only 10:39 to 11:04, cross feed normal 11:04, all boost pumps on at 11:31, center tank empty at 11:36.

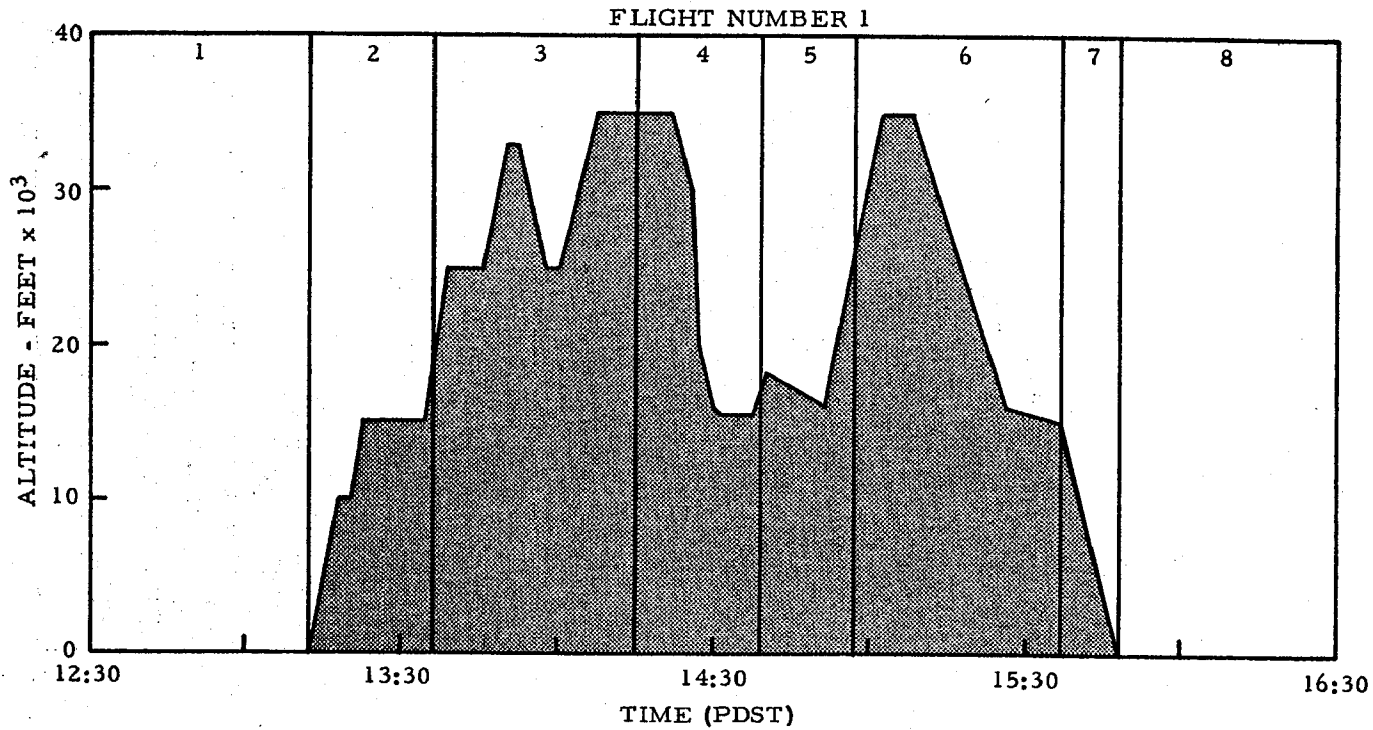

FLIGHT CONDITIONS

ZONE NO.

- 1 PRODUCTION GROUND CHECK, INERTING SYSTEM & INSTRUMENTATION CHECKS, TAKEOFF DATA & TAXI TESTS
- 2 TAKEOFF & CLIMB
- 3 TRIM, COMPASS & ENGINE CHECKS
- 4 MODIFIED BEACON EVALUATION, EMERGENCY DESCENT
- 5 APPROACHES TO STALLS
- 6 ENGINE RELIGHT ENVELOPE EVALUATION
- 7 APPROACH & LANDING
- 8 POST FLIGHT CHECKS

FIGURE 8A - FLIGHT TESTS AND PROFILES - FLIGHT NO. 1

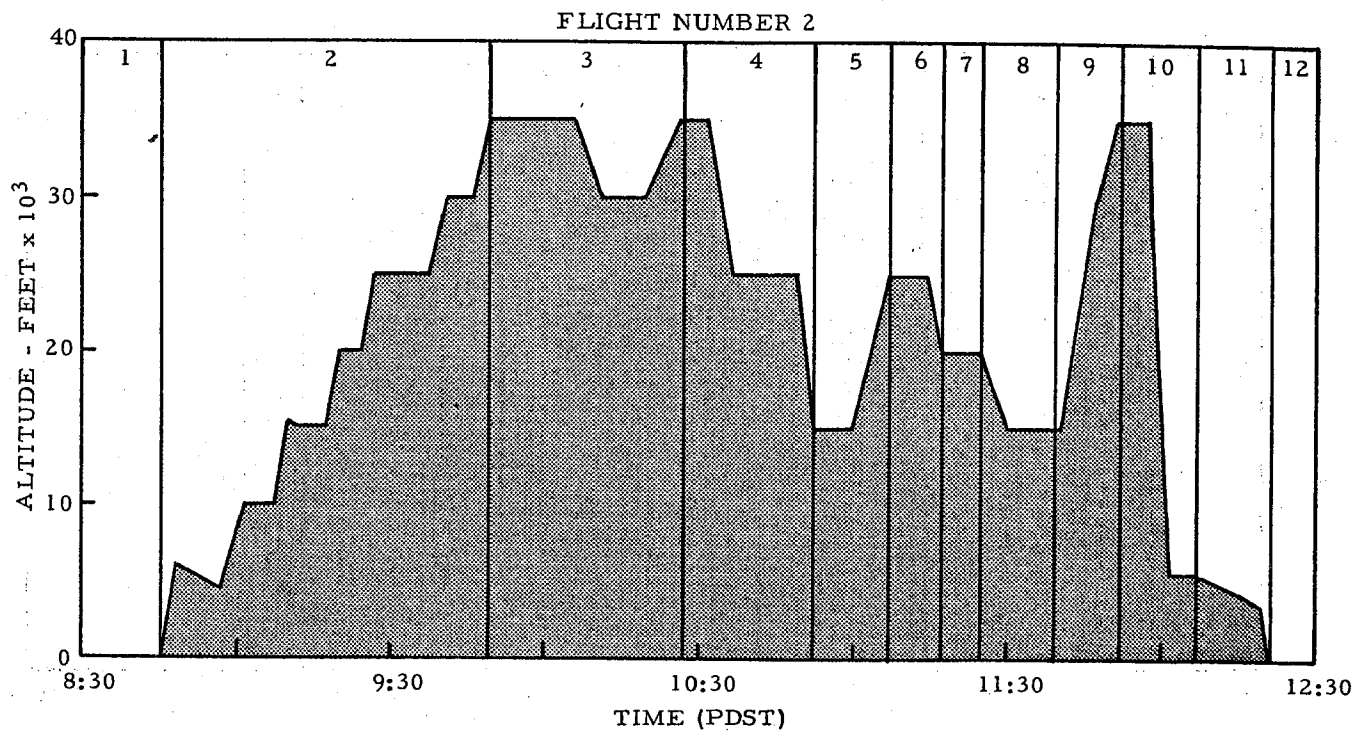

- FLIGHT CONDITIONS
- | ZONE NO. | FLIGHT CONDITIONS |
|----------|--|
| 1 | PREFLIGHT CHECKS, TAKEOFF DATA & TAXI TESTS |
| 2 | STEP CLIMB, INFLIGHT MANEUVERS, FUEL TANK VENTING EVALUATION |
| 3 | ENGINE RELIGHT ENVELOPE EVALUATION |
| 4 | STEP DESCENT |
| 5 | ZOOM CLIMB |
| 6 | ENGINE RELIGHT ENVELOPE EVALUATION |
| 7 | ZERO "G" MANEUVERS |
| 8 | APPROACHES TO STALLS |
| 9 | MAXIMUM RATE CLIMB |
| 10 | MAXIMUM RATE DESCENT |
| 11 | APPROACH & LANDING |
| 12 | POST FLIGHT CHECKS |

FIGURE 8B - FLIGHT TESTS AND PROFILES - FLIGHT NO. 2

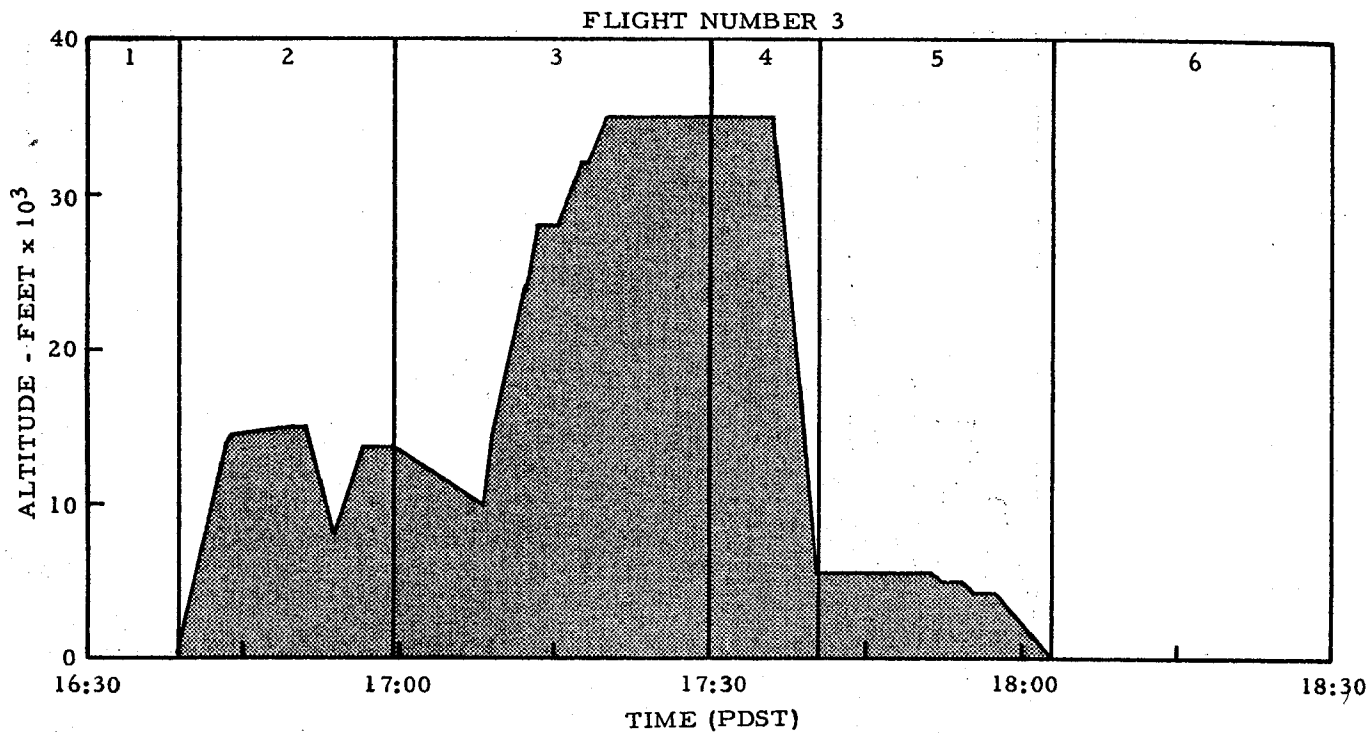

- FLIGHT CONDITIONS**
- | ZONE NO. | |
|----------|--|
| 1 | PREFLIGHT CHECK & TAKEOFF DATA |
| 2 | CLIMB, APPROACHES TO STALLS, ENGINE ACCELERATION, ENGINE RELIGHT ENVELOPE EVALUATION |
| 3 | MAXIMUM RATE CLIMB |
| 4 | MAXIMUM RATE DESCENT |
| 5 | APPROACH & LANDING |
| 6 | POST FLIGHT & PNEUMATIC SYSTEM GROUND CHECKS |

FIGURE 8C - FLIGHT TESTS AND PROFILES - FLIGHT NO. 3

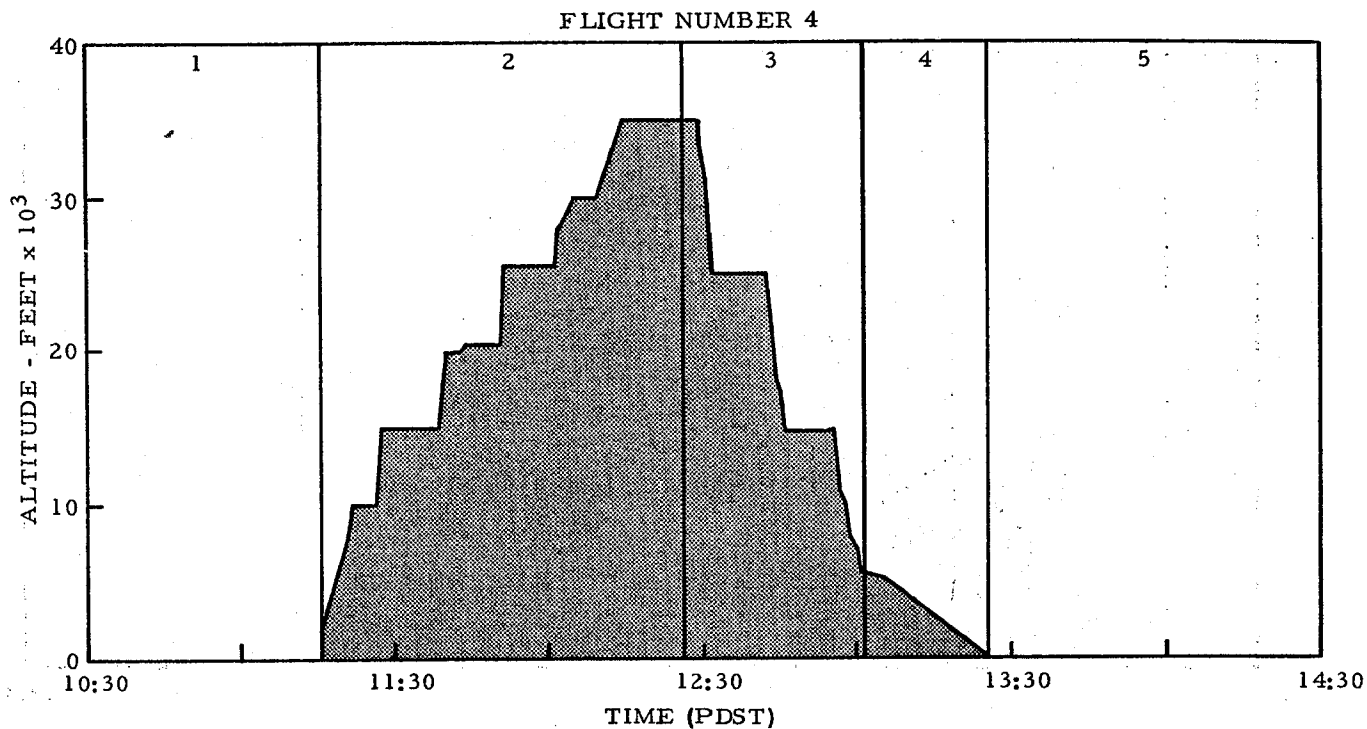

FLIGHT CONDITIONS

ZONE NO.

- 1 PREFLIGHT CHECK & TAKEOFF DATA
- 2 STEP CLIMB, INFLIGHT MANEUVERS, FUEL TANK VENTING EVALUATION
- 3 STEP DESCENT, INFLIGHT MANEUVERS, FUEL TANK VENTING EVALUATION
- 4 APPROACH & LANDING
- 5 POST FLIGHT & PNEUMATIC SYSTEM GROUND CHECKS

FIGURE 8D - FLIGHT TESTS AND PROFILES - FLIGHT NO. 4

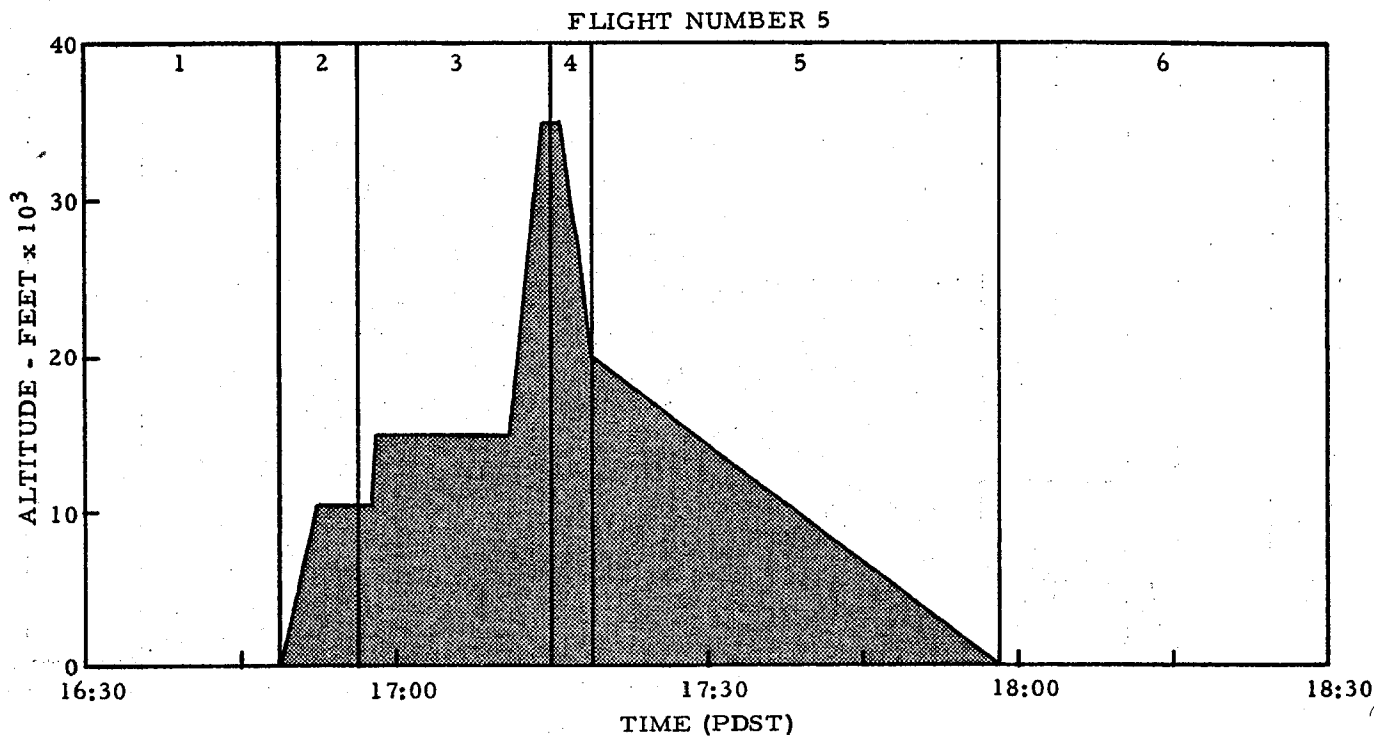

FLIGHT CONDITIONS

ZONE NO.

- 1 PREFLIGHT CHECKS, TAKEOFF DATA & TAXI TESTS
- 2 CLIMB, INFLIGHT MANEUVERS
- 3 FUEL TANK VENTING EVALUATION, ACCELERATION & ZOOM CLIMB
- 4 RAPID DESCENT
- 5 DESCENT, APPROACH & LANDING
- 6 POST FLIGHT CHECKS

FIGURE 8E - FLIGHT TESTS AND PROFILES - FLIGHT NO. 5

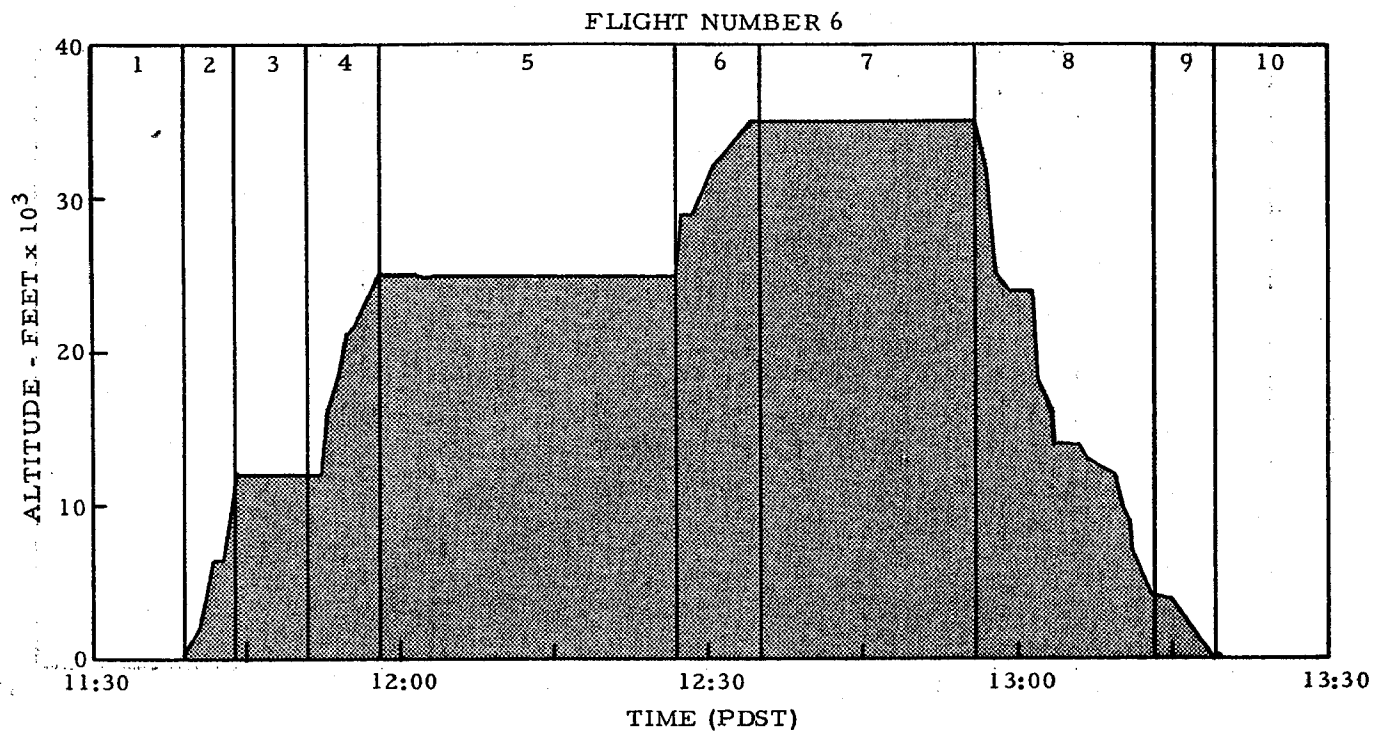

FLIGHT CONDITIONS

ZONE NO.

- 1 PREFLIGHT CHECKS, TAKEOFF DATA & TAXI TESTS
- 2 CLIMB
- 3 INFLIGHT MANEUVERS, FUEL TANK VENTING EVALUATION
- 4 ACCELERATION & CLIMB
- 5 INFLIGHT MANEUVERS, FUEL TANK VENTING
- 6 ZOOM CLIMB
- 7 EVALUATING SINGLE FUEL TANK FEED TO BOTH ENGINES
- 8 ACCELERATION & STEP DESCENT
- 9 APPROACH & LANDING
- 10 POST FLIGHT CHECKS

FIGURE 8F - FLIGHT TESTS AND PROFILES - FLIGHT NO. 6

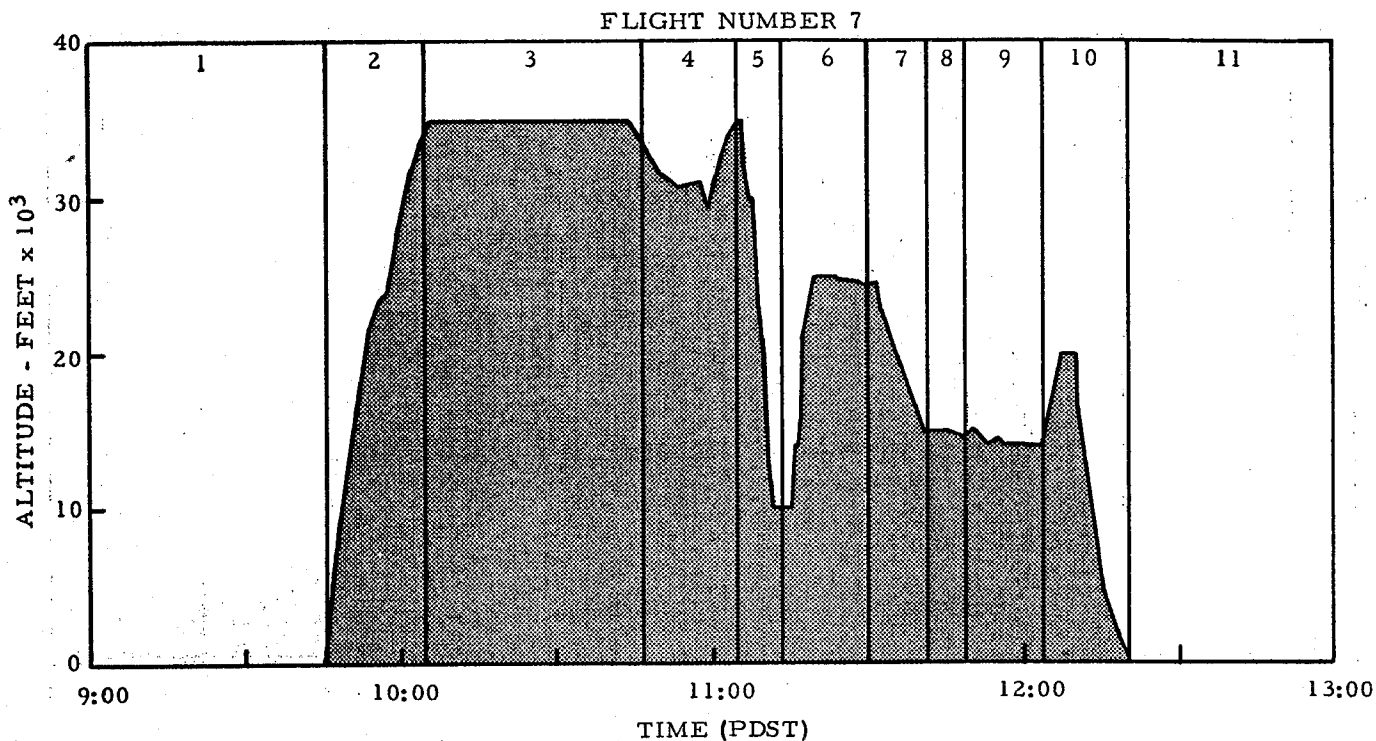

- FLIGHT CONDITIONS
- | ZONE NO. | |
|----------|---|
| 1 | PREFLIGHT CHECKS, TAKEOFF DATA & TAXI TESTS |
| 2 | CLIMB & INFLIGHT MANEUVERS, FUEL TANK VENTING EVALUATION |
| 3 | COMPASS CHECK, EVALUATING SINGLE FUEL TANK FEED TO BOTH ENGINES |
| 4 | ENGINE RELIGHT ENVELOPE EVALUATION |
| 5 | EVALUATING LN ₂ PRESSURIZATION SYSTEM & DIVE VALVES |
| 6 | ZOOM CLIMB ENGINE RELIGHT ENVELOPE EVALUATION |
| 7 | ZERO "G" MANEUVERS |
| 8 | ENGINE RELIGHT ENVELOPE EVALUATION |
| 9 | APPROACHES TO STALLS |
| 10 | APPROACH & LANDING |
| 11 | POST FLIGHT CHECKS |

FIGURE 8G - FLIGHT TESTS AND PROFILES - FLIGHT NO. 7

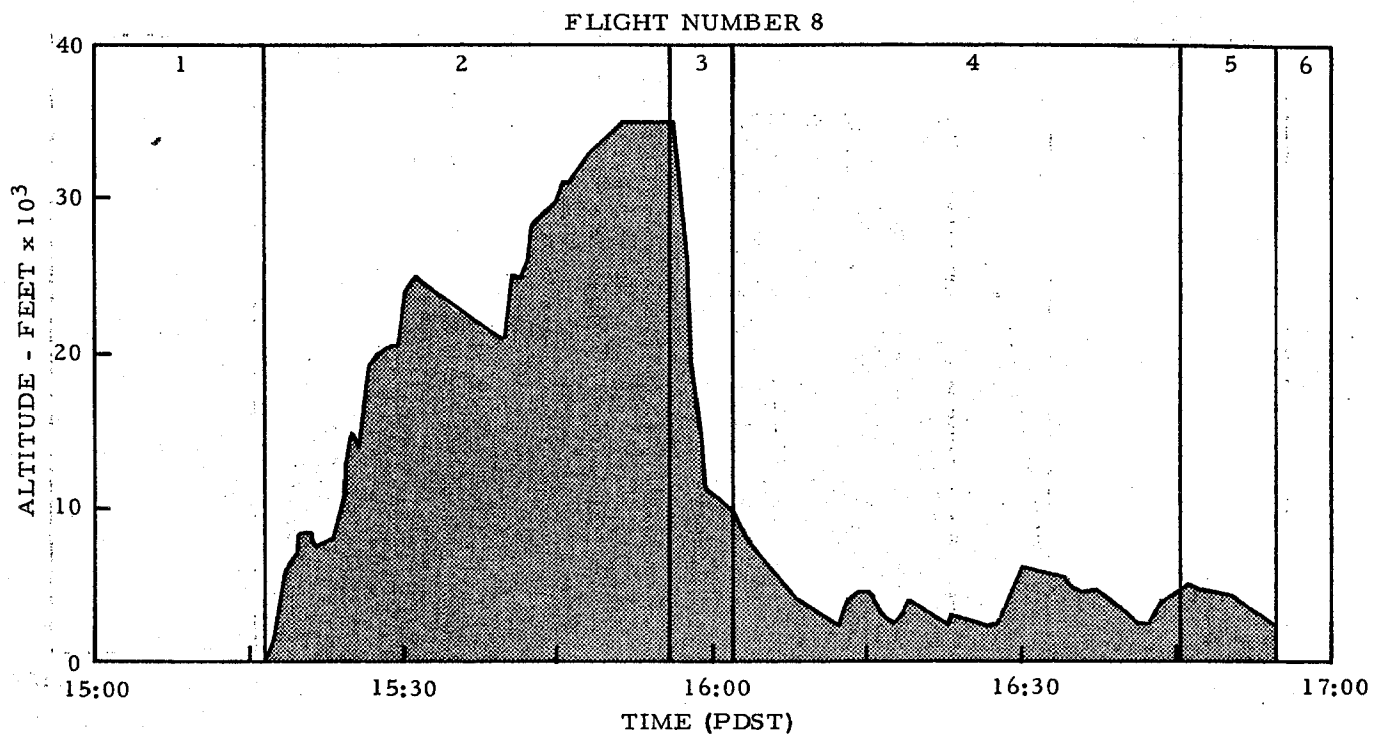

FLIGHT CONDITIONS

ZONE NO.

- 1 PREFLIGHT CHECKS, TAKEOFF DATA & TAXI TESTS
- 2 INFLIGHT MANEUVERS, FUEL TANK VENTING EVALUATION
- 3 MAXIMUM RATE DESCENT
- 4 DESCENT, TOUCH & GO LANDINGS, MISSED APPROACHES
- 5 APPROACH & LANDING
- 6 FLIGHT NUMBER 9

FIGURE 8H - FLIGHT TESTS AND PROFILES - FLIGHT NO. 8

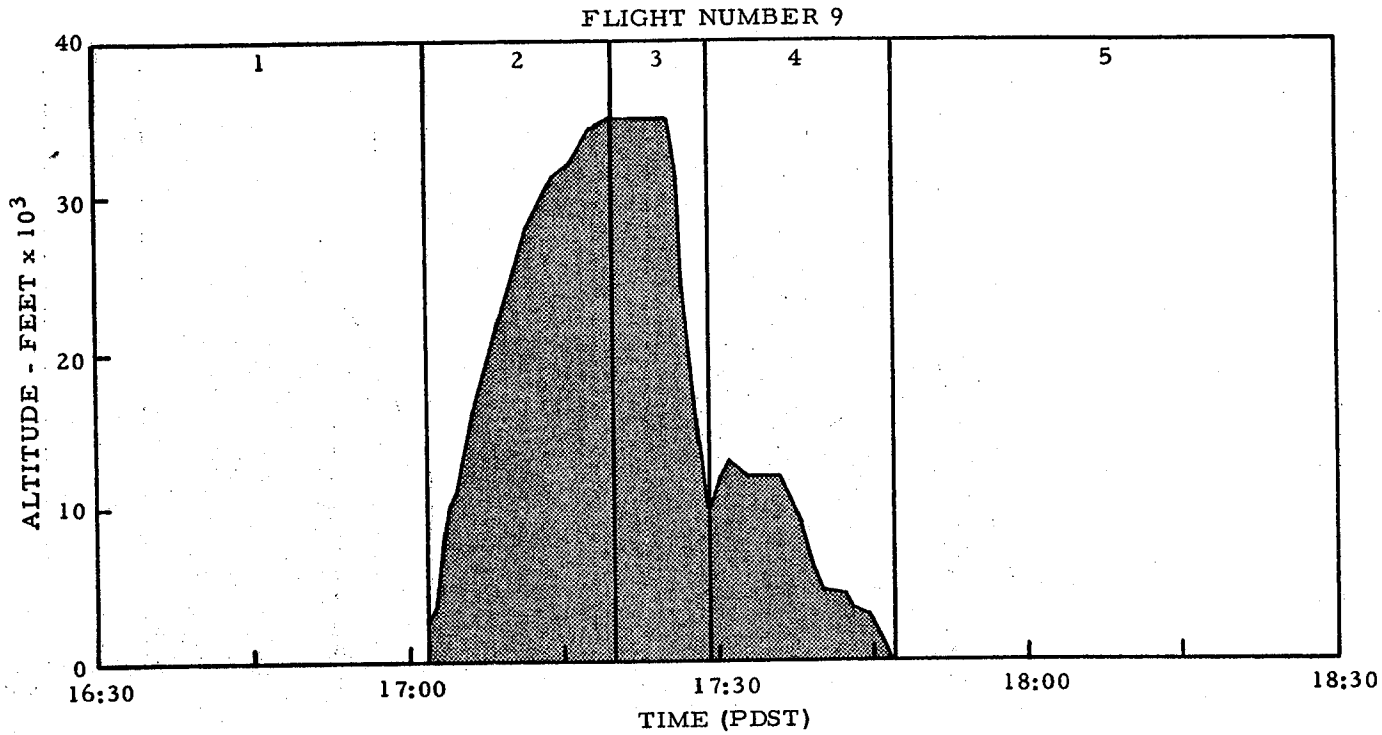

- FLIGHT CONDITIONS
- ZONE NO.
- 1 FLIGHT NUMBER 8
 - 2 MAXIMUM RATE CLIMB
 - 3 MAXIMUM RATE DESCENT
 - 4 APPROACH & LANDING
 - 5 POST FLIGHT CHECKS

FIGURE 8I - FLIGHT TESTS AND PROFILES - FLIGHT NO. 9

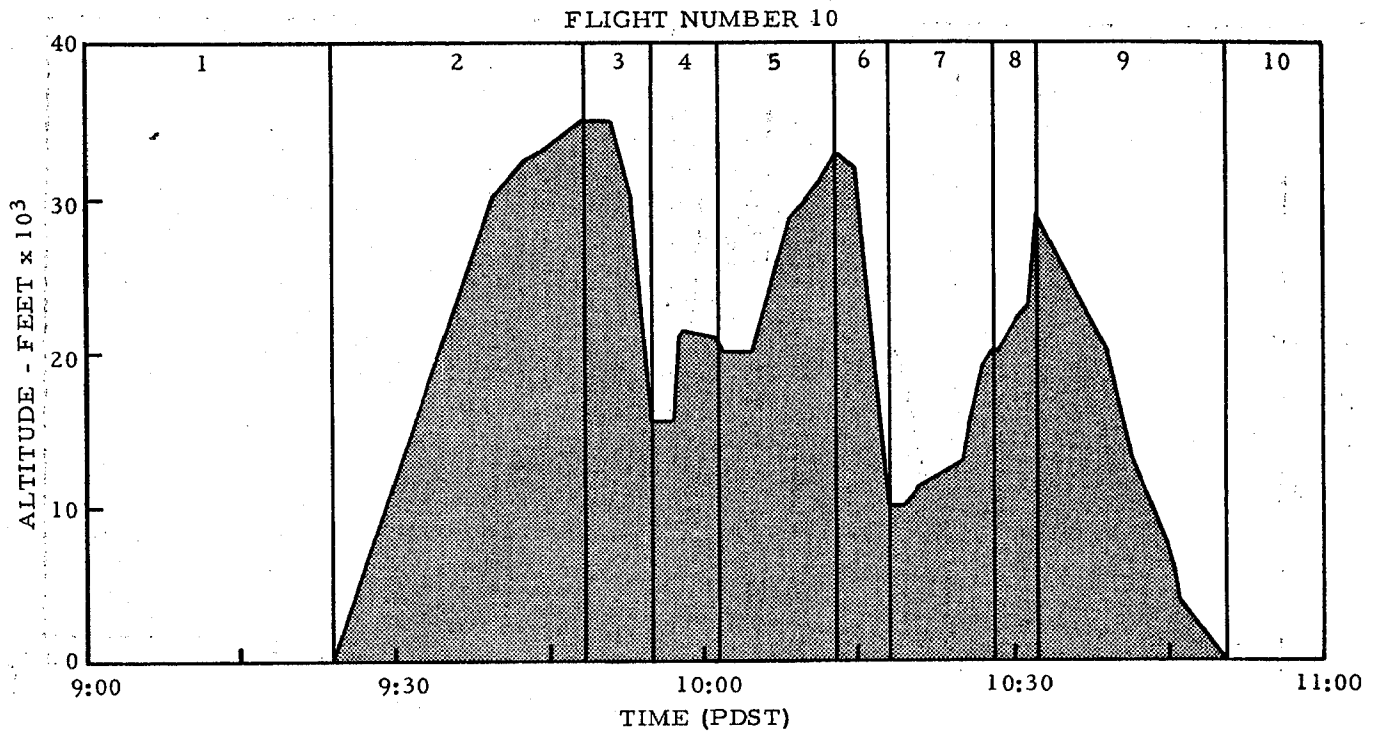

ZONE NO.	FLIGHT CONDITIONS
1	PREFLIGHT CHECKS, TAKEOFF DATA & TAXI TESTS
2	INFLIGHT MANEUVERS, FUEL TANK VENTING EVALUATION
3	RAPID DESCENT
4	ZOOM CLIMB
5	ZERO "G" MANEUVERS
6	MAXIMUM RATE DESCENT
7	ZERO "G" MANEUVERS
8	ZOOM CLIMB
9	APPROACH & LANDING
10	POST FLIGHT CHECKS

FIGURE 8J - FLIGHT TESTS AND PROFILES - FLIGHT NO. 10

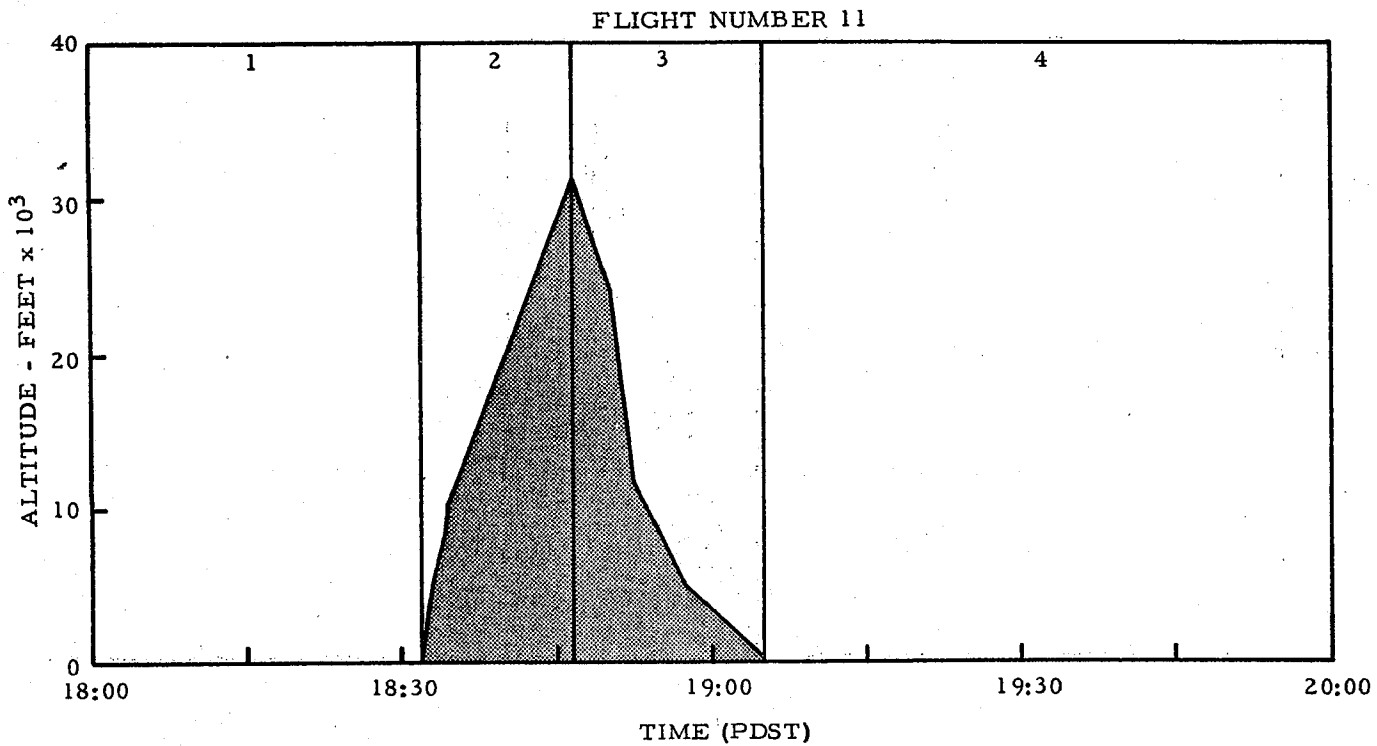

- FLIGHT CONDITIONS
- ZONE NO.
- 1 PREFLIGHT CHECKS, TAKEOFF DATA & TAXI TESTS
 - 2 INFLIGHT MANEUVERS, FUEL TANK VENTING EVALUATION
 - 3 RETURN TO BASE, APPROACH & LANDING
 - 4 POST FLIGHT CHECKS

FIGURE 8K - FLIGHT TESTS AND PROFILES - FLIGHT NO. 11

FLIGHT NUMBER 12

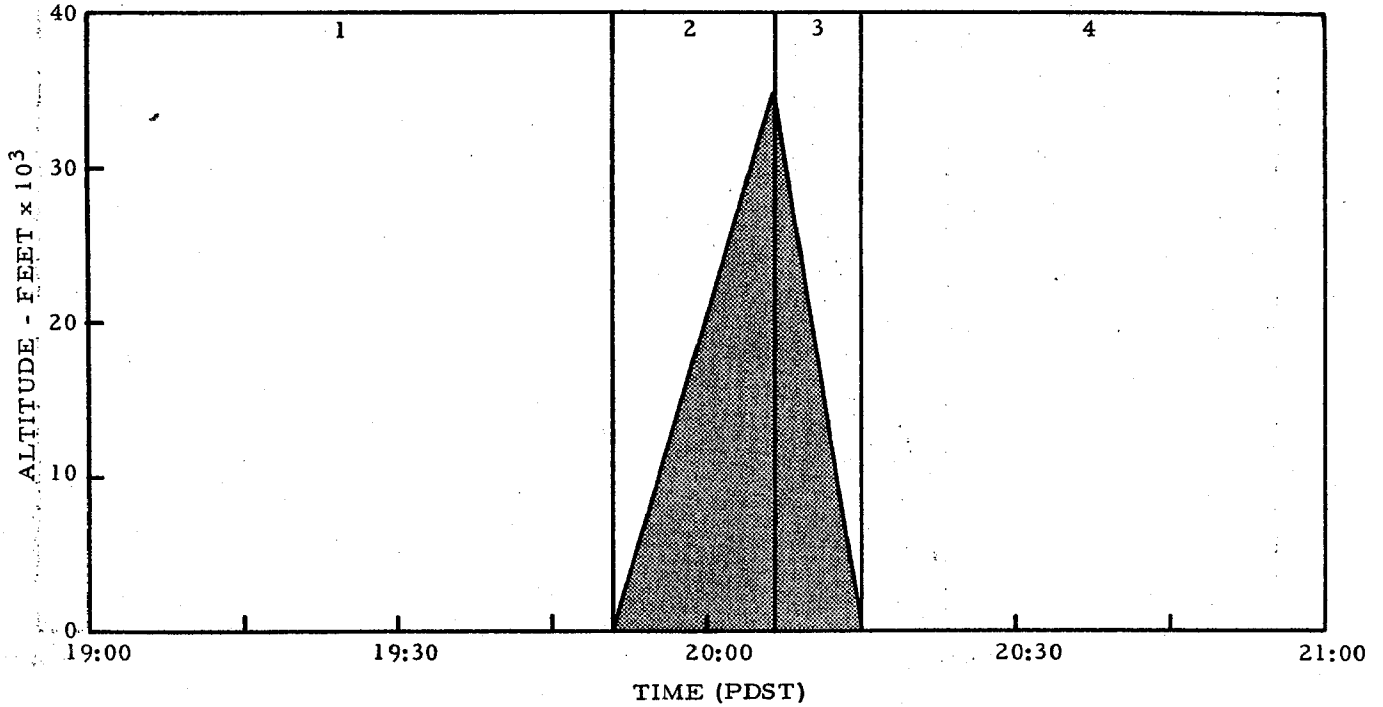

- FLIGHT CONDITIONS
- ZONE NO.
- 1 PREFLIGHT CHECKS, TAKEOFF DATA & TAXI TESTS
 - 2 INFLIGHT MANEUVERS, FUEL TANK VENTING EVALUATION
 - 3 APPROACH & LANDING
 - 4 POST FLIGHT CHECKS

FIGURE 8L - FLIGHT TESTS AND PROFILES - FLIGHT NO. 12

TABLE 2. - SUMMARY OF OXYGEN CONCENTRATION MEASUREMENTS

Test Flight No.	Sampling Time (PDST)	Sample Location No.	Volumetric Oxygen Concentrations		
			In-Flight Oxygen Analyzer (percent)	Mass Spectrometry Analysis Airborne (percent)	Laboratory (percent)
1	12:15	2	NA	21.1	NA
1	13:26	4	19.8	21.0	NA
1	13:43	4	20.2	19.4	NA
1	14:10	2	21.5	20.7	18.8
1	14:35	4	21.5	20.5	18.9
1	16:01	2	21.0	20.0	18.0
1	16:06	6	21.8	20.4	18.5
2	8:26	2	20.8	20.5	18.5
2	9:13	4	20.9	20.9	18.9
2	9:29	4	21.2	21.1	19.0
2	9:51	8	24.0	24.0	21.0
2	10:00	3	21.9	21.2	NA
2	10:41	8	24	23.5	22.0
2	10:54	6	21.6	21.0	NA
2	11:09	2	NA	20.7	NA
2	11:51	2	22.5	22.3	20.4
2	12:06	3	22.0	20.8	19.7
2	12:08	8	21.6	20.3	19.6
3	16:21	2	4.9	4.8	4.2
3	17:24	3	5.4	5.2	4.7
3	17:43	3	2.4	2.0	1.7
3	18:06	6	0.1	0.1	0.1
4	10:47	4	5.6	5.2	5.0
4	11:31	4	7.1	7.6	6.7
4	11:55	3	4.8	4.2	3.7
4	12:17	3	5.0	4.4	3.9
4	12:38	3	4.7	4.2	3.7
4	12:51	8	< 0.7	0.5	NA
4	12:34	3	1.2	1.1	0.9
6	11:29	4	NA	NA	3.4
6	11:48	3	2	NA	1.7
6	12:38	4	5.6	NA	2.8
6	13:08	4	1.8	NA	1.5
7	9:31	3	3.4	NA	3.4
7	10:14	5	6.7	NA	3.8
7	10:26	5	7.0	NA	4.1
7	11:22	4	2.0	NA	1.8
7	12:21	4	0.3	NA	0.6
8	15:53	5	5.6	NA	3.3

The sample probes in the wing tanks and the vent lines were submerged in fuel during the initial portions of the flights with the tanks full. The vapor spaces in the wing tanks were small and moved between wingtip and root during climb and cruise with changing attitude. The normal procedure of emptying the center tank before operating from the wing tanks prevented continuous sampling from the wing tanks until after reaching cruise altitude. Probe 1 in the left tank typically did not clear of fuel until the fuel in the tank was down to 85 percent of the normal full fuel load and the aircraft was 1 1/2 hours into the flight and at cruise altitude. Likewise, Probes 8 and 7 in the right wing tank did not clear until the fuel load was down 5 and 20 percent, respectively, and the aircraft was 1 1/4 to 1 3/4 hours into the flight. The three probes in the center tank normally cleared of fuel during the climb to altitude. The forward probe (No. 3) was clear at brake release with a normal full fuel load. The center probe (No. 4) was clear after approximately 15 percent of the fuel was used from the center tank and typically within 5 minutes after takeoff and at an altitude between 10,000 and 15,000 feet. The aft probe (No. 5) was clear within the first half hour of flight as the aircraft approached cruise altitude. Approximately 60 percent of the fuel was withdrawn from the center tank by the time this third probe was clear of fuel.

Fuel leakage into the vent lines through the drain valves, prior to incorporating the service bulletin modification after Flight 5, resulted in the vent line probes also being submerged in fuel until venting cleared the lines. This condition was further intensified when the tank expansion spaces were filled with fuel. The vapor samples from the vent lines were not normally clear of fuel during the initial flights with the tanks full until after reaching cruise altitudes. As previously discussed, the leaking vent system drain float valve assemblies were replaced after Flight 5 with spring-loaded flapper-type valves. The vent line samples after this modification were clear shortly after takeoff with the tanks initially full and prior to reaching cruise altitude with the tank expansion spaces full of fuel.

The venting of fuel from both vent boxes throughout the climb was observed during the initial inerted flights with normal full and maximum fuel loads. This problem is considered to have been primarily due to the vent system drain float valves not seating properly. The vent lines contained fuel prior to the flights as a result of overfilling the tanks or leakage through these drain valves. The fuel in the vent lines was then forced by tank pressurization with nitrogen, into the vent boxes during preflight checkout of the climb and dive valves and as a result of leakage in the vent boxes or across these valves. Any additional fuel leakage or spillage into the vent lines prior to and during the flight was then forced into the vent boxes and overboard as the climb valves opened during the ascent. Since the vent boxes and vent lines drained into the wing tanks, the venting of fuel continued until the fuel level in the wing tanks allowed the vent system to drain or the aircraft leveled off and the climb valves closed.

The service bulletin modifications to the vent drain valves substantially decreased the amount of fuel being vented overboard. With the leakage of fuel into the vents eliminated, the only fuel which entered the vent systems was considered to have resulted from spillage into the open bellmouth fittings as the tanks were overfilled or during ground and in-flight maneuvers. With the inboard drain valves for each vent line relocated from the main tanks to the center tanks, any fuel trapped in the vent lines between the float valves and the vent boxes was drained early in the flight when the fuel level in the center tank was lowered below the fuel level in the vent lines.

The effect of the oxygen rich gases dissolved in the unscrubbed fuel being released as the tank pressures decreased during the climb to altitude was noted during the initial test flights. As reported in References 2, 3 and 4, when an aircraft ascends, a relatively large quantity of gas is evolved from the fuel and due to the different solubility coefficients and partial pressures of oxygen and nitrogen, the gas is much richer in oxygen than standard air. Data reported by B. A. Faulkner and E. C. G. Jelfs in Reference 5 indicated that the gas being released from the fuel would have a theoretical volumetric oxygen concentration of 32 percent. This value was substantiated by the experimental results reported in References 3 and 4 and the average experimental solubility values of nitrogen and oxygen in fuels reported in Reference 2.

Fuel vapor in the tanks and functional ground checks of the nitrogen inerting system prior to the first flight reduced the preflight oxygen concentration of the tank vapors to approximately 19 1/2 percent with the inerting system inoperative. The release of gases from the partially scrubbed fuel raised the oxygen concentration to approximately 22 percent at altitude.

The second flight was conducted with the fuel unscrubbed, the tanks uninerted, and the vent box climb and dive valves operating. The oxygen concentrations in the right main tank increased from approximately 21 to 25 percent during the flight.

These initial flights were not intended to provide measurements of oxygen concentrations under conditions critical to the release of the dissolved oxygen-rich gases. The partially scrubbed fuel for the first flight and the step climb profiles for both flights tended to lower the oxygen level in the tank vapor spaces by reducing the relative amount of oxygen dissolved in the fuel and by mixing the released gases with atmospheric air. The fuel withdrawn at each leveling off altitude during the climb tended to be replaced by air entering through the vents. With the climb and dive valves pneumatically opened during the first flight, air enters the vent box unrestricted. During the second flight with the climb and dive valves operating, the tank was pressurized during the climb by the expanding vapors in the tank. However, air could enter the tank during level flight as fuel was withdrawn or tank leakage lowered the

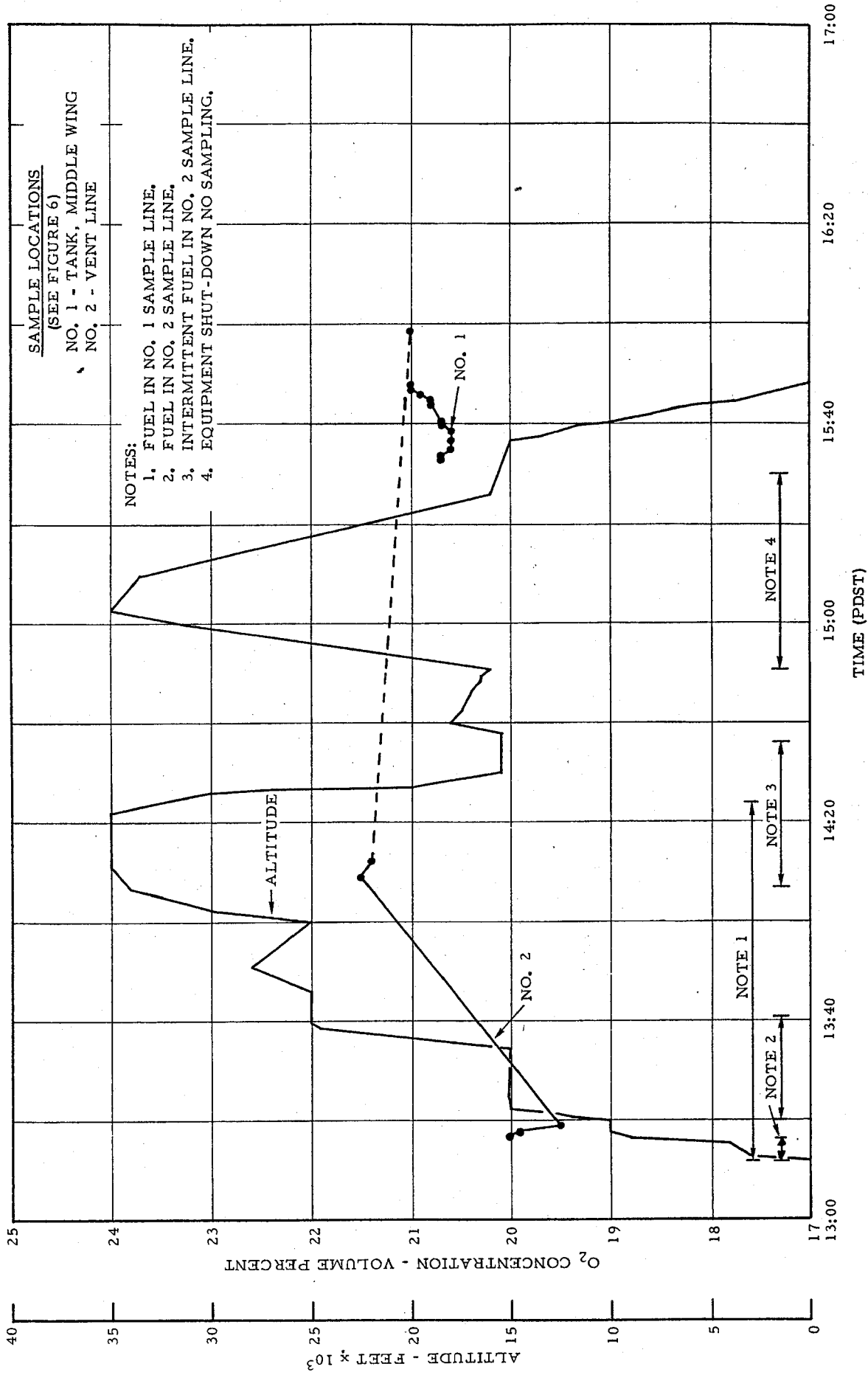

FIGURE 9 - OXYGEN CONCENTRATIONS IN LEFT MAIN FUEL SYSTEM FOR FLIGHT 1

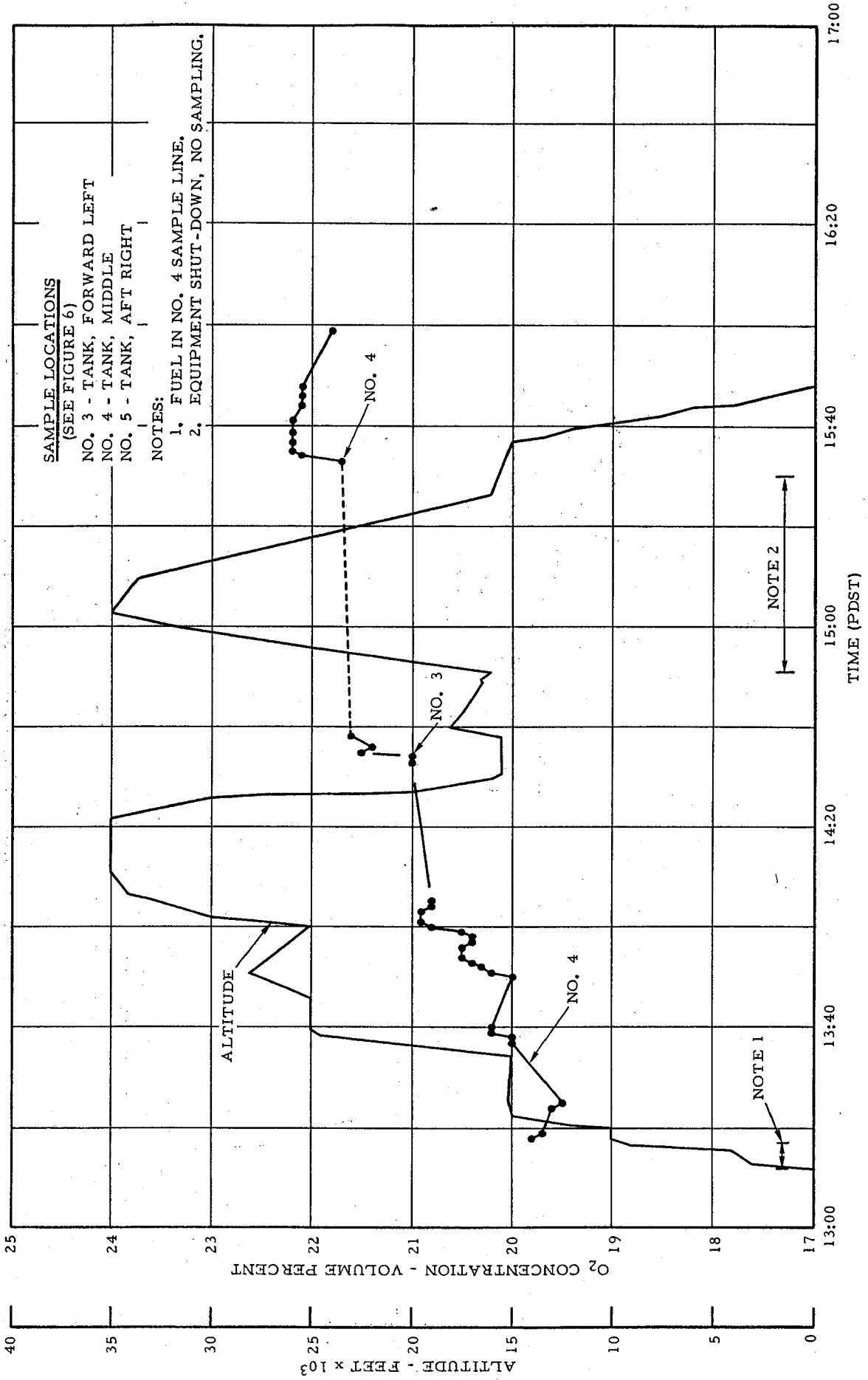

FIGURE 10 - OXYGEN CONCENTRATIONS IN CENTER FUEL TANK FOR FLIGHT 1

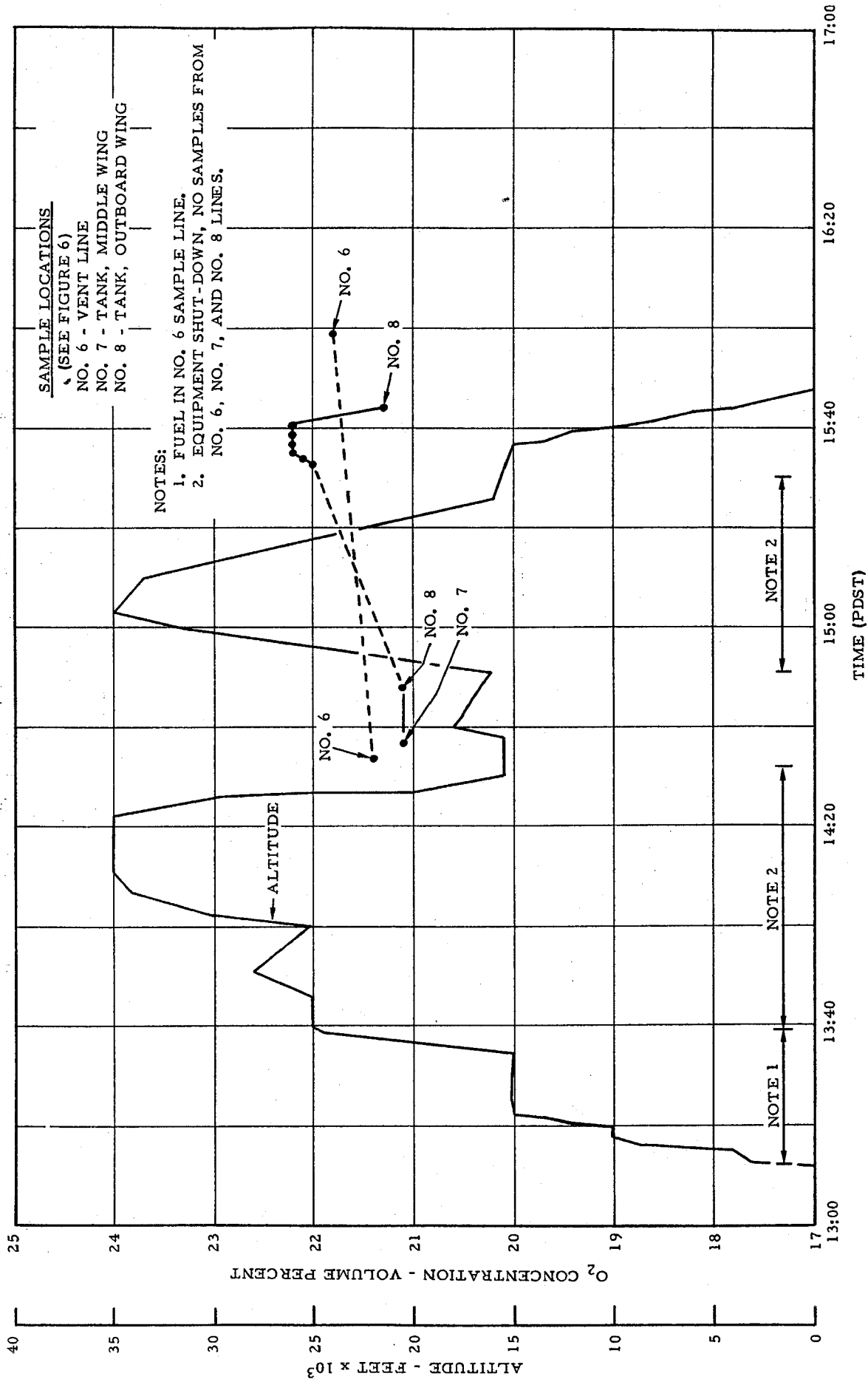

FIGURE 11 - OXYGEN CONCENTRATIONS IN RIGHT MAIN FUEL SYSTEM FOR FLIGHT 1

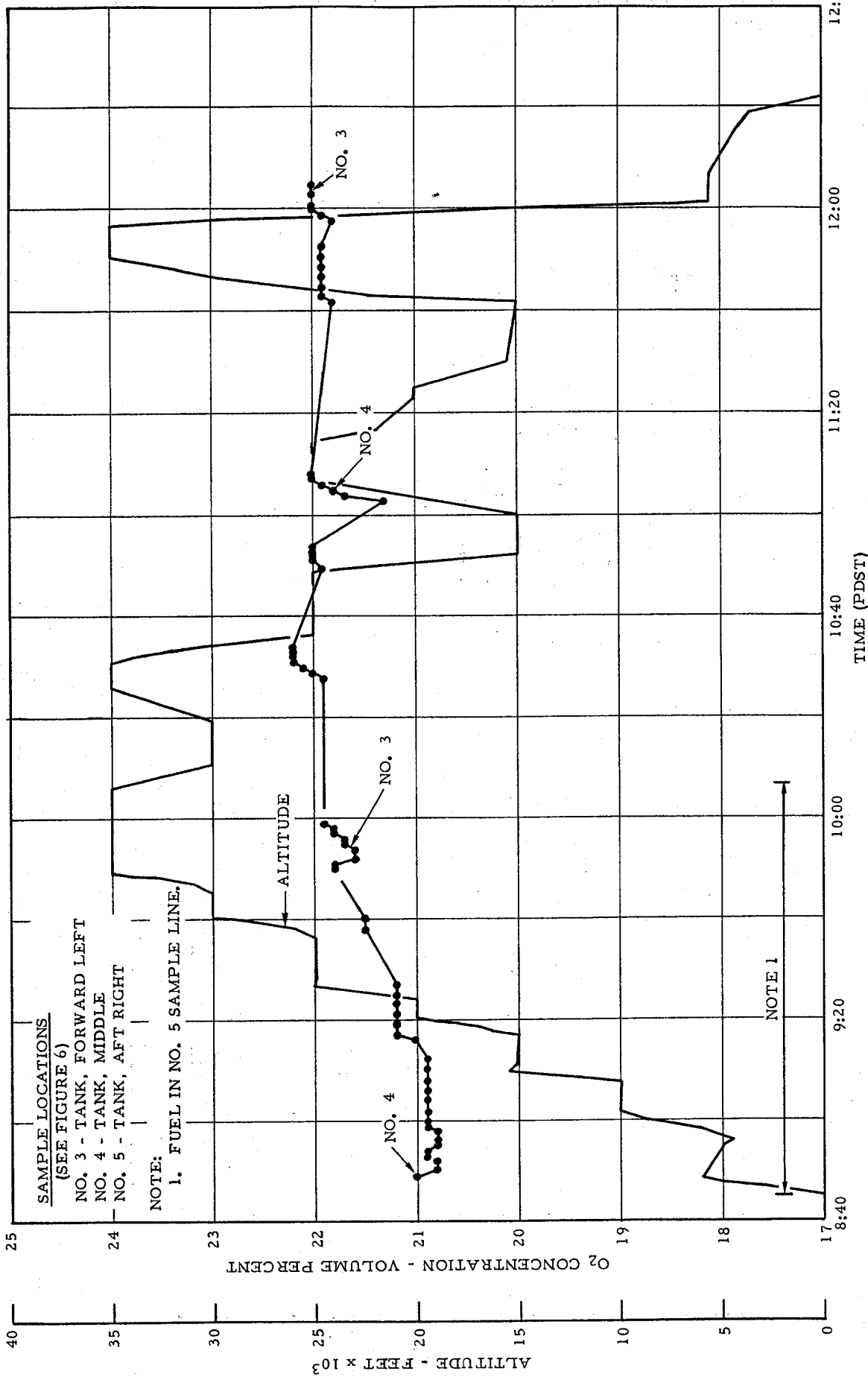

FIGURE 12 - OXYGEN CONCENTRATIONS IN CENTER FUEL TANK FOR FLIGHT 2

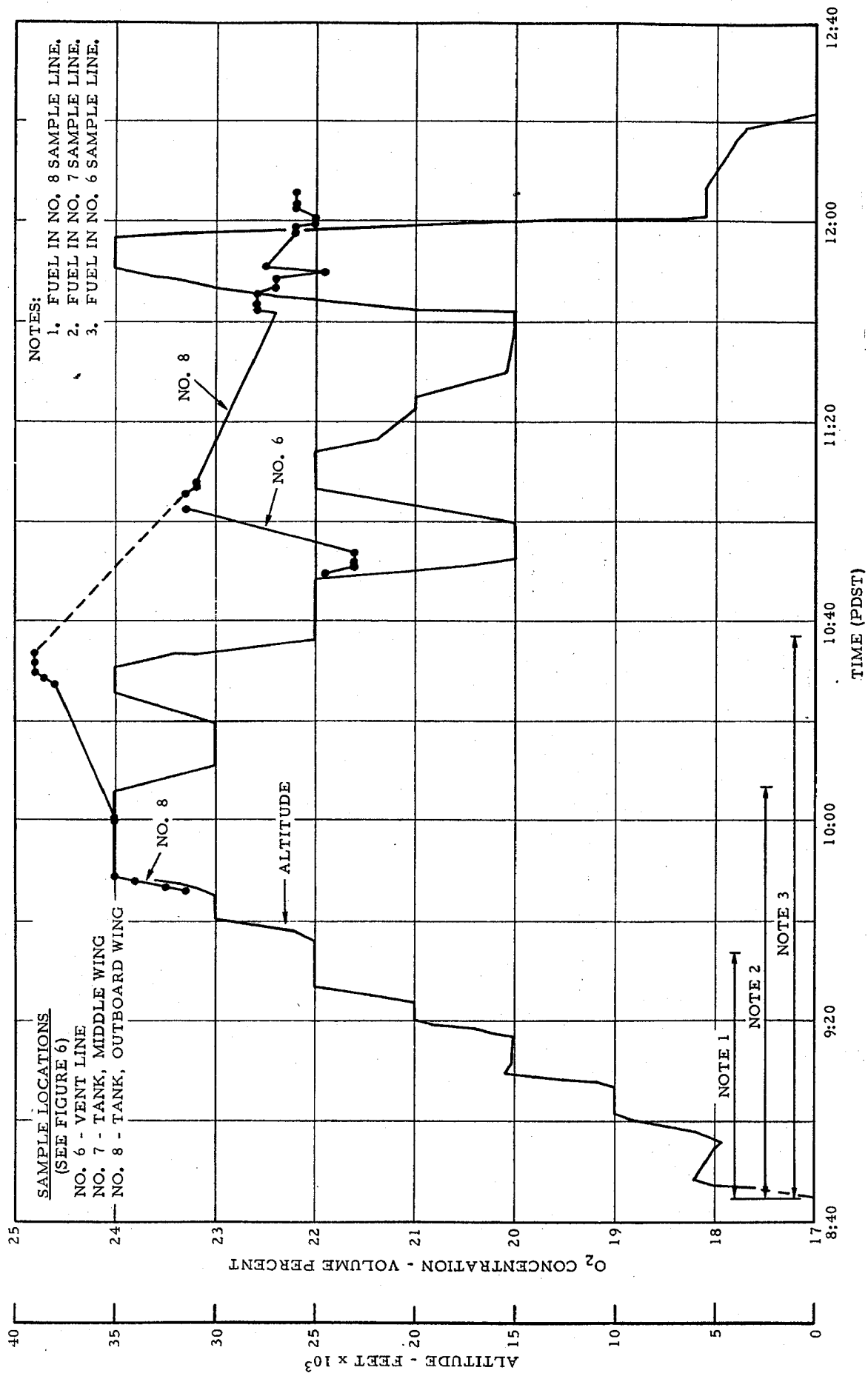

FIGURE 13 - OXYGEN CONCENTRATIONS IN RIGHT MAIN FUEL SYSTEM FOR FLIGHT 2

pressure sufficiently to open the dive valves. Assuming the tanks were air tight, calculations indicate that air would enter the tank with fuel being used from the center tank, in less than 3 minutes with the combined fuel in the center and right tanks greater than 90 percent capacity. This time increases to 15 minutes with the center tank nearly empty and the aircraft at cruise altitude. The withdrawal of fuel from the center or right main tank during each level flight portion of the step climb of Flight 2 was sufficient to lower the tank pressure and open the dive valve for the center and right fuel tank. The fuel consumed from the left tank during level flights, starting at the 20,000-foot level, allowed the dive valve for the left tank to open. The maximum fuel load and the fuel in the vent lines during Flight 2 prevented oxygen measurements from the left tank and delayed measurements from the right tank until the engines were operating on fuel from the main tanks and the aircraft was approaching the top of the climb. The initial air in the tanks, the fuel consumed prior to the flight, the tank leakage under pressure, and the air entering through the dive valves during the level flight portions of the step climb are factors considered to have caused the oxygen concentrations to remain significantly below the reported 32-percent value.

Another factor to be considered in discussing the effect of oxygen-enriched gases being released from the fuel on the oxygen concentration in the tanks and vents is whether or not the aircraft has descended to the point that the dive valves have opened. With the tanks unpressurized, as in Flight 1, any descent would allow air to enter the vent box. With the exception of minor overshoots in the step climbs, this did not happen during Flight 1 until the aircraft had climbed to the 28,000-foot altitude.

The tanks were pressurized by expanding vapors during a climb with the climb and dive valves operating. A descent of sufficient magnitude to reduce the tank pressure differential to the opening setting of the dive valves was then required in order for air to enter the tanks. Ignoring fuel consumption and tank leakage, calculated altitude changes ranging from 5,400 to 1,600 feet starting from the 40,000- and 2,000-foot altitude, respectively, were required to lower the tank differential pressures sufficiently to open the dive valves and allow air into the vent. The descents alone during Flight 2 were not of sufficient magnitude to open the dive valves until reaching the 35,000-foot altitude.

With the fuel tank inerting system operating, the nitrogen pressurization prevents the dive valves from opening and air entering the vents as the fuel is consumed or as the aircraft descends. However, the oxygen concentration is still influenced by the flight profile, the fuel withdrawn and tank leakage. Calculations for the DC-9, again ignoring the effect of tank leakage, indicate that in less than 4 minutes after leveling off from a climb, sufficient fuel would be consumed from the center tank to lower the tank differential pressure sufficiently to activate the nitrogen pressurization system. Descents following a climb ranging from 1,500 to 400 feet (starting at a 40,000- and 2,000-foot altitude, respectively) also would activate the nitrogen pressurization system. If the descent occurs after level flight, the pressurization system would already be operating and would continue to operate as the aircraft descends.

The oxygen concentrations in the left main tank during Flight 3 are shown in Figure 14 to have generally followed the flight profile curve. The oxygen level increased during the climb as the gases evolved from the fuel, remained constant during level flight, and decreased during descents as the flow of nitrogen maintained a positive tank differential pressure. The effects of altitude changes on the tank oxygen level were reduced by the light fuel load and the relatively large volume of vapor space existing in the tanks throughout this flight.

The left tank vent line oxygen concentration prior to and during Flight 3 was 2 percent higher than the internal tank concentration. A possible explanation for this is the remote location of the vent probe relative to the tank pressurization nozzle. The nitrogen released into the tank following the climb to altitude would be expected to influence the oxygen concentration in the tank before the vent, since a period of time is required for this nitrogen to enter the vent by natural mixing. However, since the tank oxygen level neither exceeded 4.2 percent nor showed a substantial increase as a result of the climb to altitude, this would not explain how the level of oxygen in the vent reached 6 percent.

The oxygen concentration in the center tank during Flight 3 is shown in Figure 15. Again the oxygen level increased with altitude, generally remained constant or decreased as nitrogen replaced the fuel being consumed during level flight and decreased during the decent. However, there were deviations from this relationship due to probable vent leakage. This leakage was substantiated by the fact that the oxygen concentration (1) after ground operation and a steady climb to 14,500 feet, was below the preflight concentration; (2) decreased from 5 to 4.4 percent as the aircraft made a slow climb from 14,500 to 15,000 feet; and (3) did not increase as the aircraft climbed from 8,000 to 14,000 feet. The difference in oxygen levels at Probe Locations 3 and 4 were not significant during this flight. The oxygen level in the center tank was generally 1/2 to 2 percent higher than in the left tank.

The oxygen concentration in the right tank during Flight 3 remained low throughout the flight, never exceeding 2.1 percent (see Figure 16). Again the oxygen level tended to follow the flight profile curve. As expected, since the right and center tanks have a common vent system, the suspected vent valve leakage was also reflected in the oxygen concentration measurement in the right tank. A decrease in the oxygen level from 3.2 to 1.7 percent occurred prior to takeoff. The small increases in oxygen concentration during the climb to 15,000 feet and from 10,000 to 35,000 feet were further evidence of valve leakage. The differences in concentration measurements between probes at Locations 6, 7, and 8 were not significant during Flight 3. Since the oxygen level in the right vent line was lower than the center tank level at the end of the climb to 35,000 feet and slightly higher than the right tank level, and since the fuel was being consumed from the main tanks, a vent flow from the right tank to the vent box is indicated. This is additional evidence that the leakage occurred in the vent box.

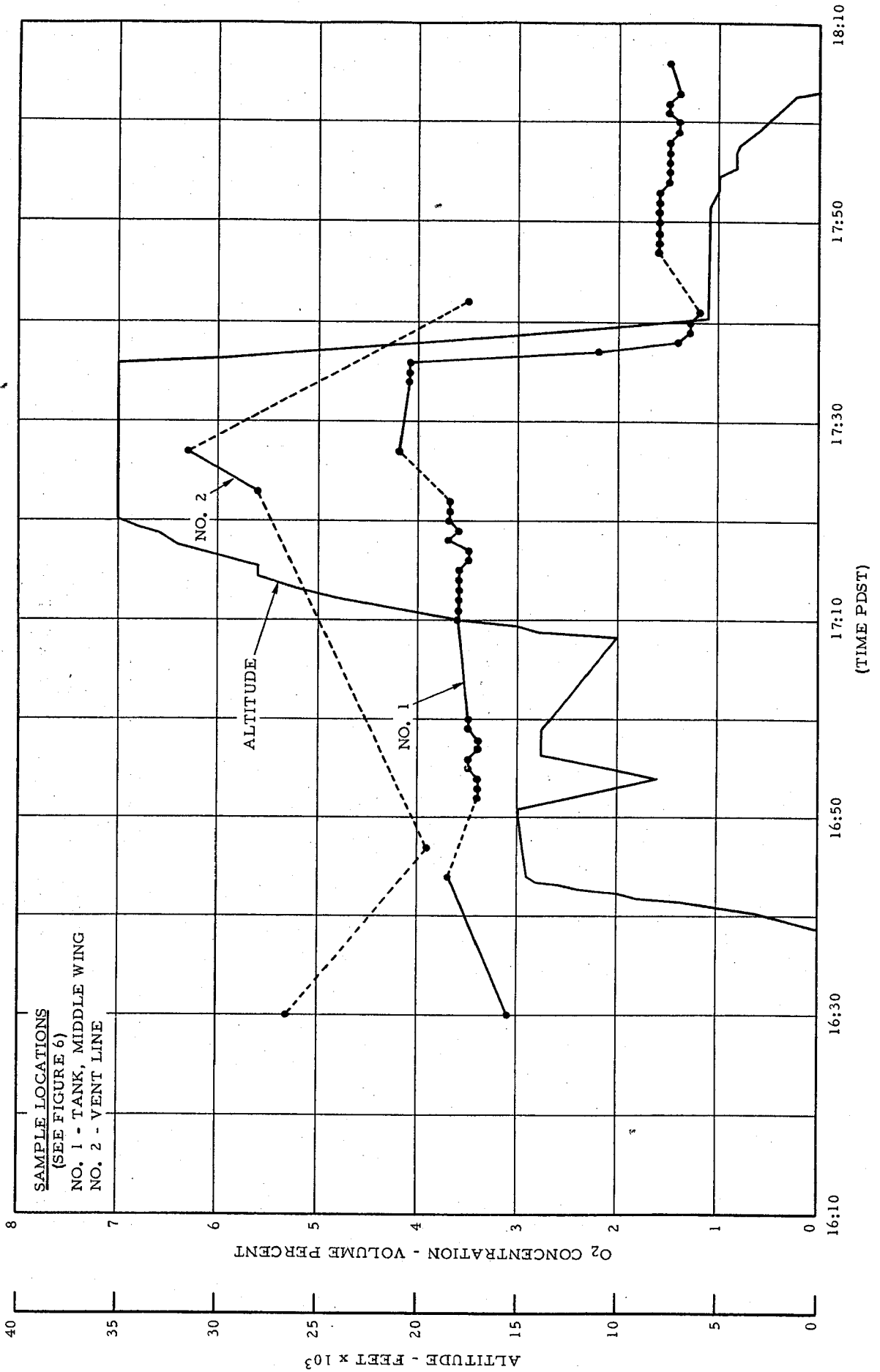

FIGURE 14 - OXYGEN CONCENTRATIONS IN LEFT MAIN FUEL SYSTEM FOR FLIGHT 3

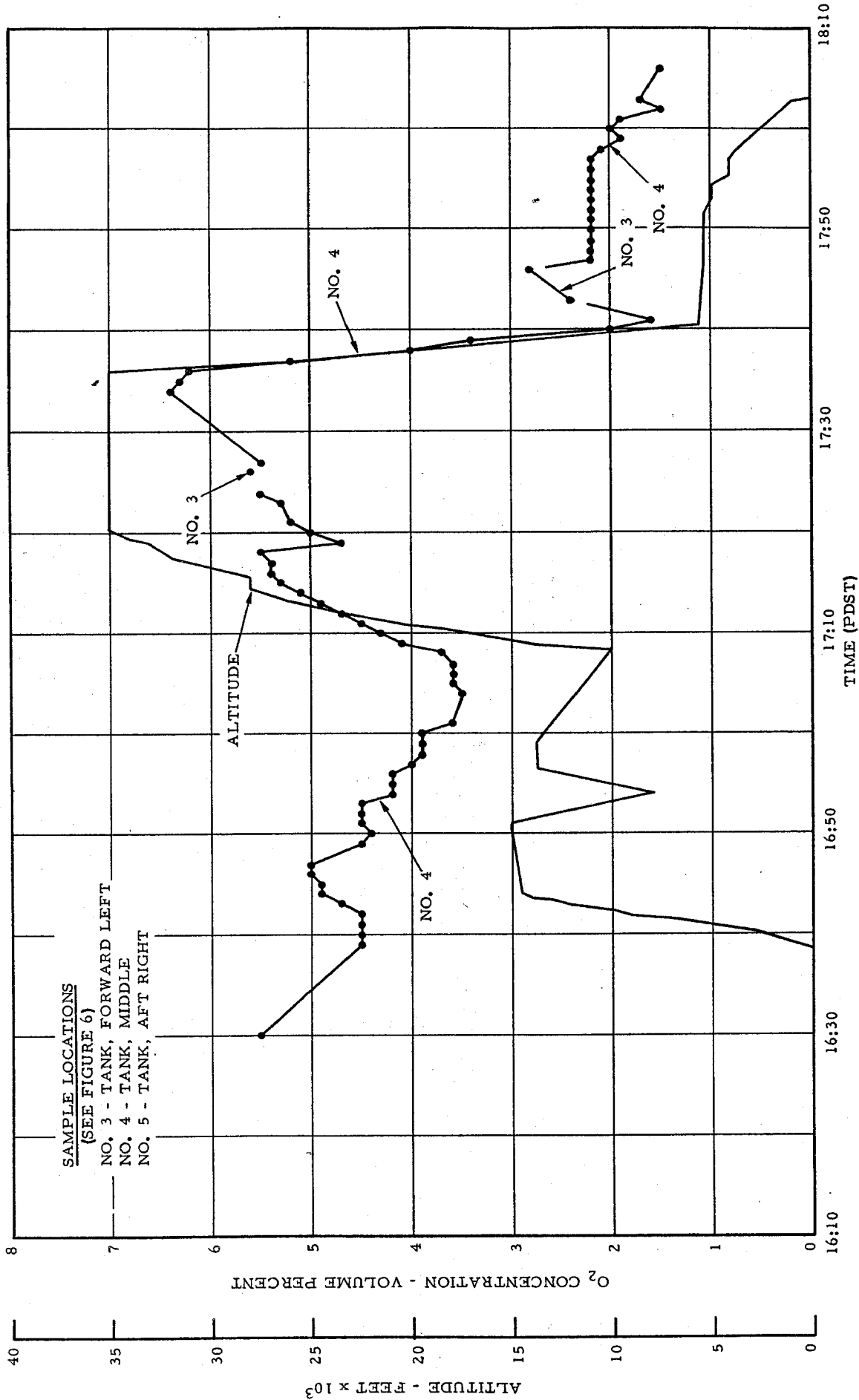

FIGURE 15 - OXYGEN CONCENTRATIONS IN CENTER FUEL TANK FOR FLIGHT 3

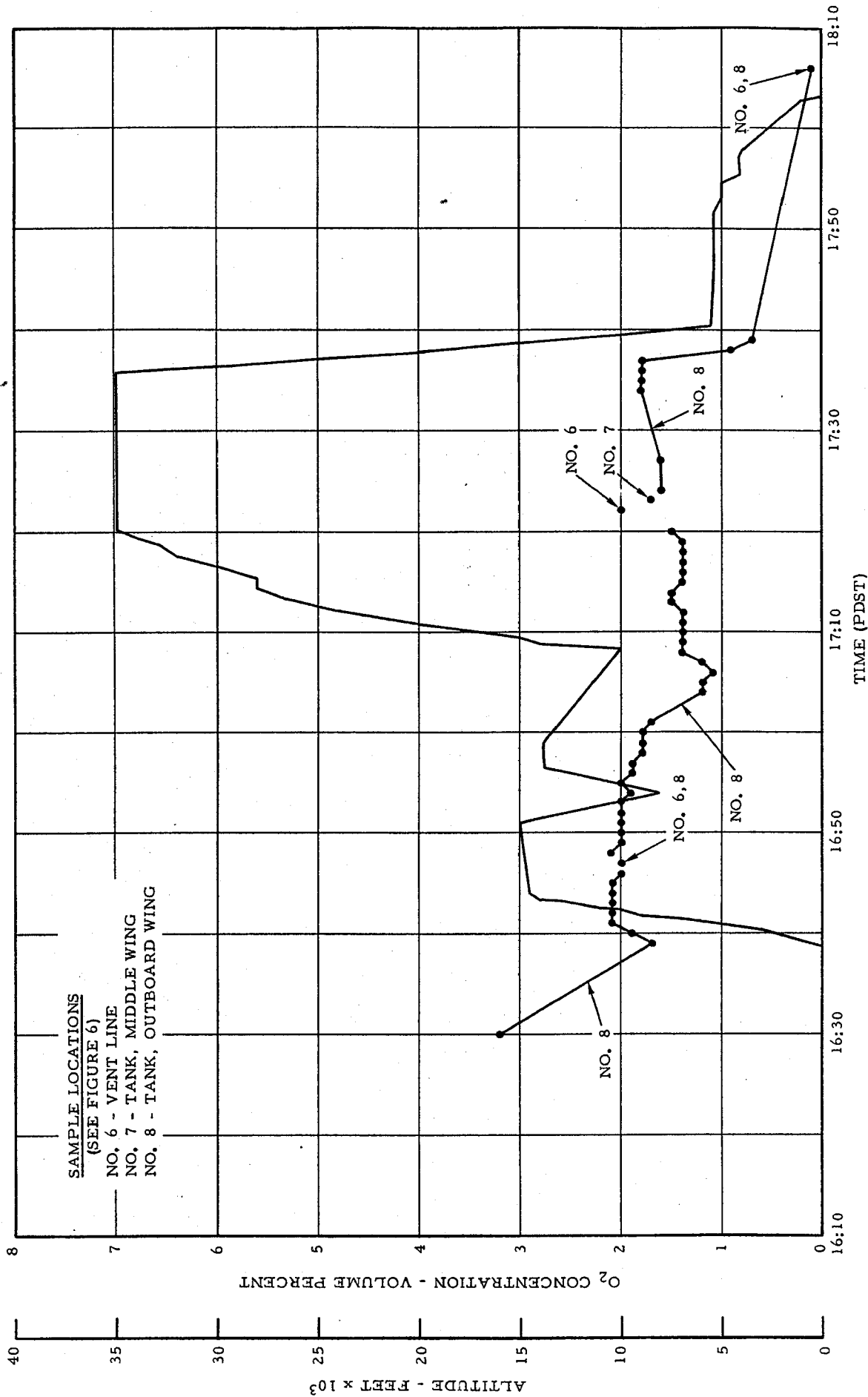

FIGURE 16 - OXYGEN CONCENTRATIONS IN RIGHT MAIN FUEL SYSTEM FOR FLIGHT 3

The difficulty in obtaining samples clear of fuel during the first two flights was again experienced during Flight 4. The oxygen sample from the left tank vent was first noted to be sufficiently clear of fuel for analysis during the descent from 25,000 to 15,000 feet (see Figure 17). Since the initial vent line measurement occurred 2 minutes prior to leveling off at 15,000 feet, the oxygen level in the vent at 15,000 feet is considered to have decreased approximately 1/2 to about 1 1/2 percent. The oxygen level in the left tank at 15,000 feet would then have been less than 1 percent lower than in the vent line.

The oxygen measurements in the center tank during Flight 4 are shown in Figure 18. Although the oxygen level generally followed the flight profile, as experienced in the preceding flight, vent valve leakage was again evident during Flight 4. This flight was conducted with the secondary valve unseated as noted during the preflight check. In addition to lowering the oxygen level in the center tank during level flight while fuel was being consumed from the main tanks, the valve leakage is considered to have caused the fuel venting to continue after leveling off in the step climb. The increase in the oxygen concentration of the center tank during level flight at 25,000 feet could also be attributed to the unseated dive valve allowing a quantity of air into the vent system during the descent from 35,000 feet. This increase in oxygen level in the center tank is evident, but to a lesser degree, following each descent during Flight 4. However, since a positive tank differential pressure was maintained throughout the descent, the oxygen increases are not considered to have been the result of air entering the vent system. The oxygen concentration did not vary significantly as the sampling in the center tank was changed from Location 4 to Location 3.

As shown in Figure 19, sufficient fuel was consumed from the main tanks for measuring the oxygen level outboard in the right tank as the aircraft was step climbing at 20,500 feet. The dive valve leakage had apparently lowered the tank oxygen concentration to a level approaching 0.7 percent by the time the sample was clear of fuel. The oxygen level in the right tank remained below 0.7 percent for the balance of Flight 4. The oxygen concentration in the left main tank vent line, prior to Flight 6, was less than 1 percent (see Figure 20). The oxygen concentrations for this flight were not necessarily representative values of the system performance since the vent boxes were opened after scrubbing the fuel.

During Flight 6, the fuel selector valve was positioned to feed both engines from the left main tank while cruising at 35,000 feet. The oxygen concentration in the left tank vent line increased from 1 to approximately 17 percent. The differential pressure during the climb to 35,000 feet had apparently exceeded the high setting of the pressure limiter. This caused the isolation valve to close and shut off the nitrogen supply to the tanks. The isolation valve normally opens before the tank differential pressure reaches zero and the dive valve opens. If the isolation valve had opened, the pressure regulators would have

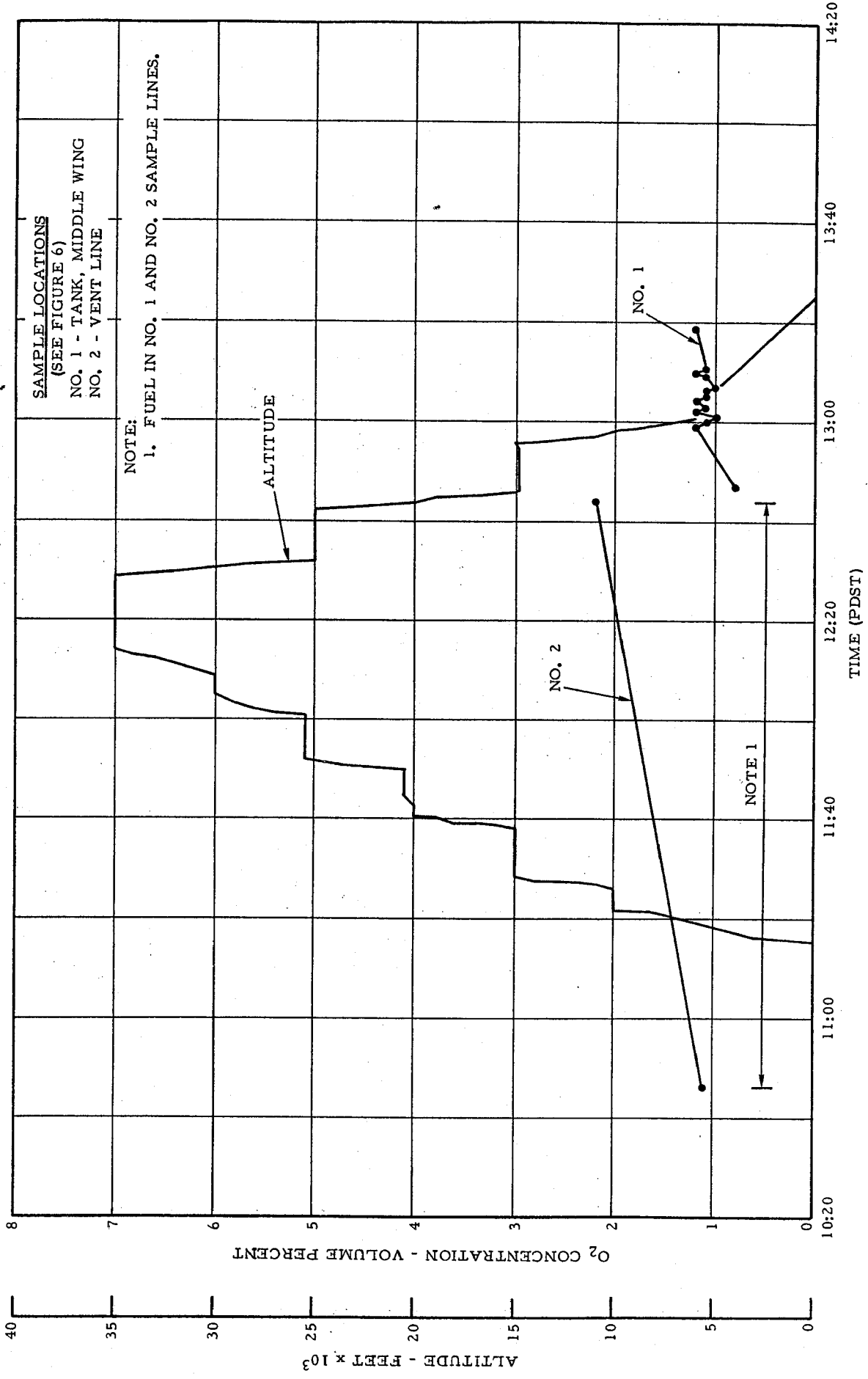

FIGURE 17 - OXYGEN CONCENTRATIONS IN LEFT MAIN FUEL SYSTEM FOR FLIGHT 4

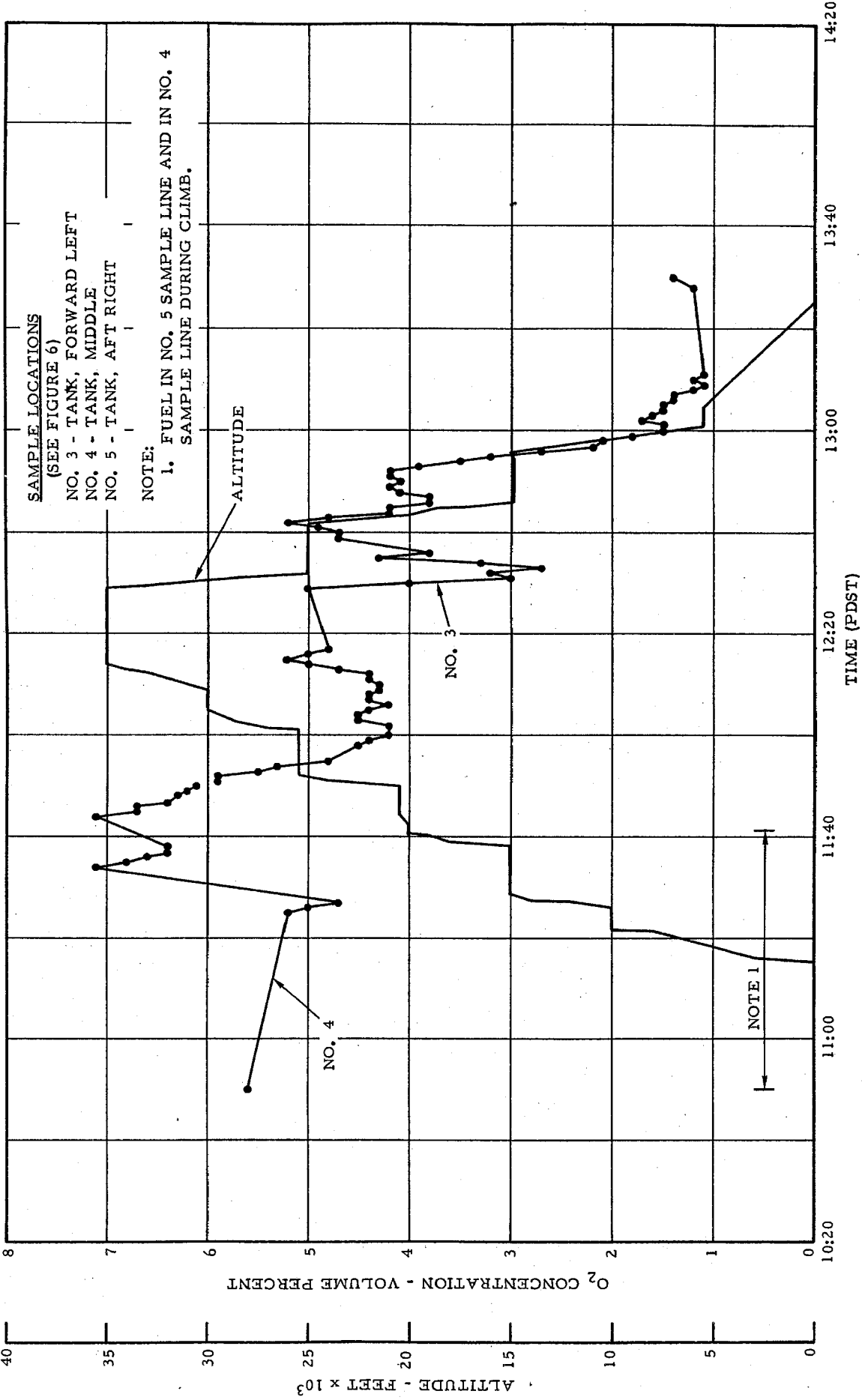

FIGURE 18 - OXYGEN CONCENTRATIONS IN CENTER FUEL TANK FOR FLIGHT 4

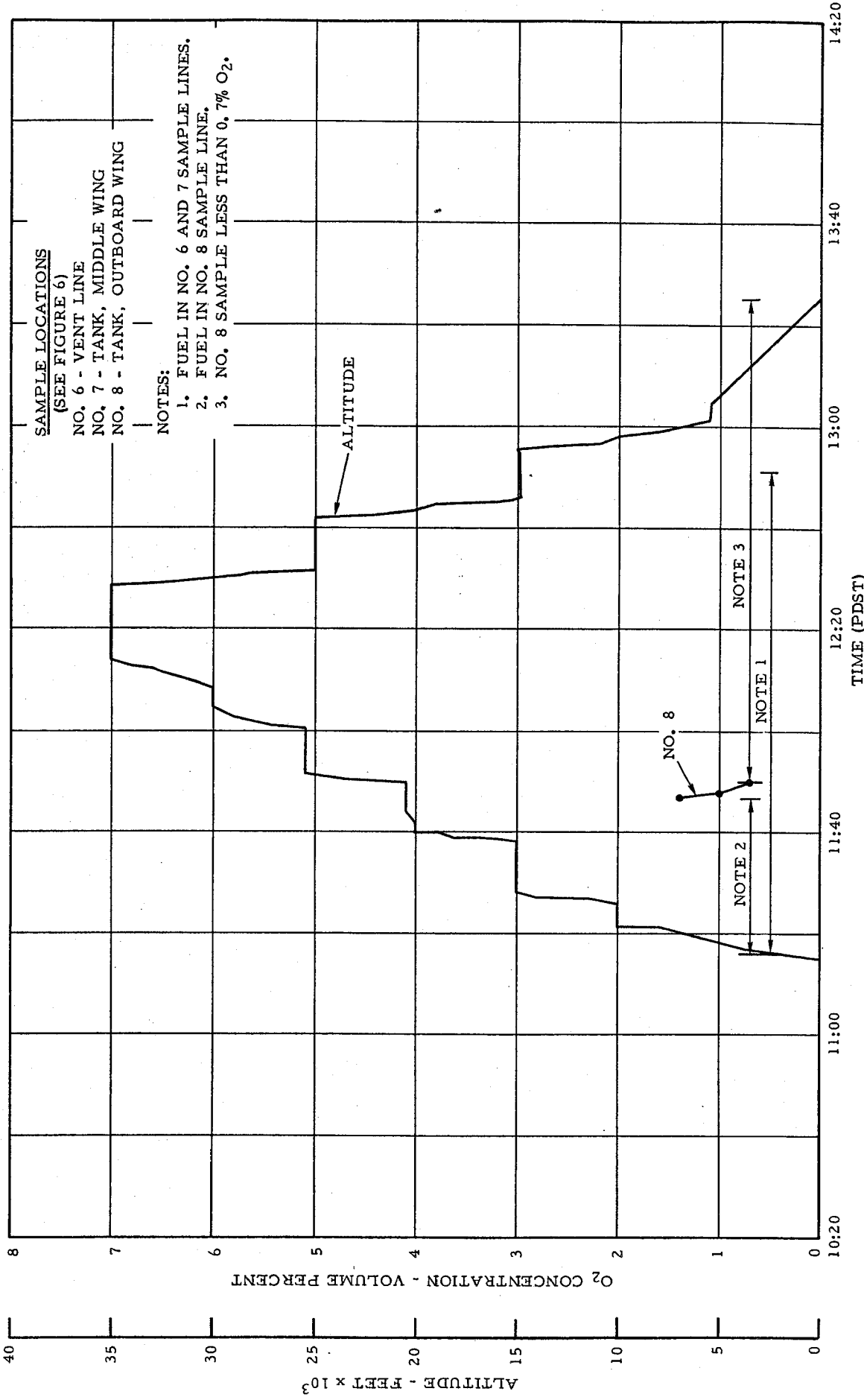

FIGURE 19 - OXYGEN CONCENTRATIONS IN RIGHT MAIN FUEL SYSTEM FOR FLIGHT 4

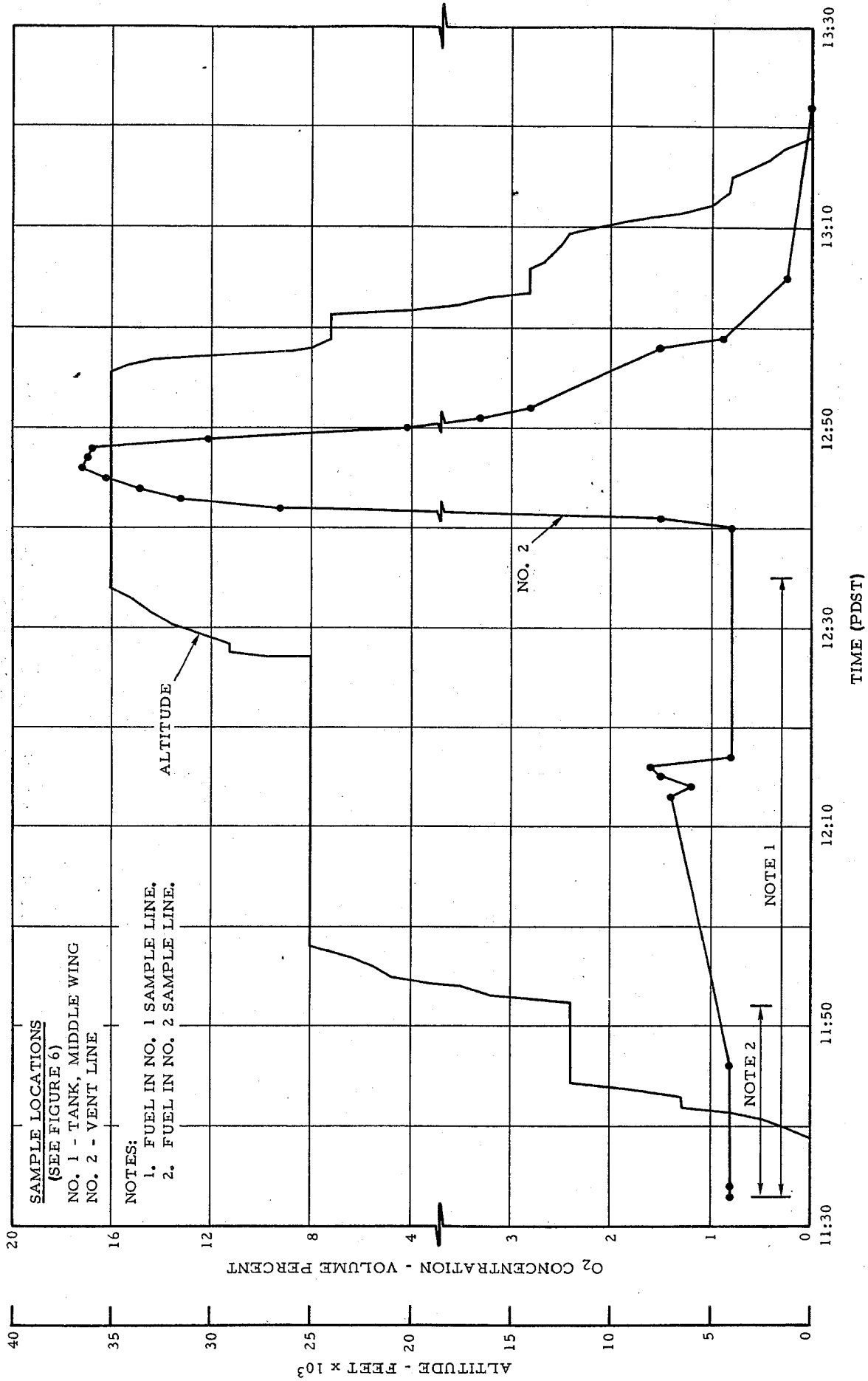

FIGURE 20 - OXYGEN CONCENTRATIONS IN LEFT MAIN FUEL SYSTEM FOR FLIGHT 6

maintained a positive tank pressure. However, during Flight 6 with both engines being fed from the left tank, the left tank pressure decreased while the right tank pressure remained constant or decreased at a slower rate. The priority valve was functioning properly and directing only the higher right main tank pressure to the limiter as the left tank pressure became negative and the dive valve opened admitting air into the vent system. When the fuel selector valve was changed to feed both engines from the right main tank, the limiter sensed the decrease in the right tank pressure through the priority valve and opened the isolation valve. Nitrogen was then supplied to both main tanks to maintain system operating pressures. When the fuel selector was changed back to feed both engines off the left tank, the isolation valve was open and remained open and the inerting system continued to operate properly. Only a small quantity of air had apparently entered the left main tank since, when the isolation valve opened, the oxygen concentration in the vent line decreased from 17 to less than 3 percent in less than 4 minutes. The settings of the pressure limiter were increased following this flight so that the isolation valve would open at a pressure above the settings of the regulator and primary climb valves.

As shown in Figure 21 for Flight 6, the oxygen concentration in the center tank closely followed the flight profile. The only deviation from this relationship occurred after the aircraft leveled off at 12,000 feet. The decrease in the oxygen level from 4 to 2 1/2 percent cannot be attributed to the fuel consumption alone. An investigation following the flight test program revealed that the oxygen sensors response characteristics deteriorated with accumulated operating time and required occasional rejuvenation to maintain a fast response rate. Starting with Flight 6, this slow instrument response was noted on Channels 2 and 3, sensing the center and right tank oxygen levels respectively, whenever measurements were made following draining fuel from the fluid traps in the sample streams. Since cabin air was normally used to drain these traps, a large step change in the oxygen concentration occurred as the instrument was switched from cabin air to sampling from the inerted tanks.

The oxygen level in the right main tank was less than 1 percent prior to Flight 6 (see Figure 22). An in-flight sample clear of fuel was not obtained until after reaching the 25,000-foot altitude. The decrease in the oxygen level from 4 to 1 1/2 percent following the initial in-flight sampling from the right tank is again attributed to slow instrument response following the draining of the fluid trap. The oxygen concentration in the right tank tended to follow the predictable trend of increasing during climbs, decreasing during level flight with fuel being consumed, and decreasing during descents. The post-flight oxygen concentration in the right tank was measured at zero percent.

Flight 7 was intended to test the capability of the scrub subsystem to maintain an oxygen level below 9 percent under critical conditions. The conditions considered critical to peak oxygen concentrations were:

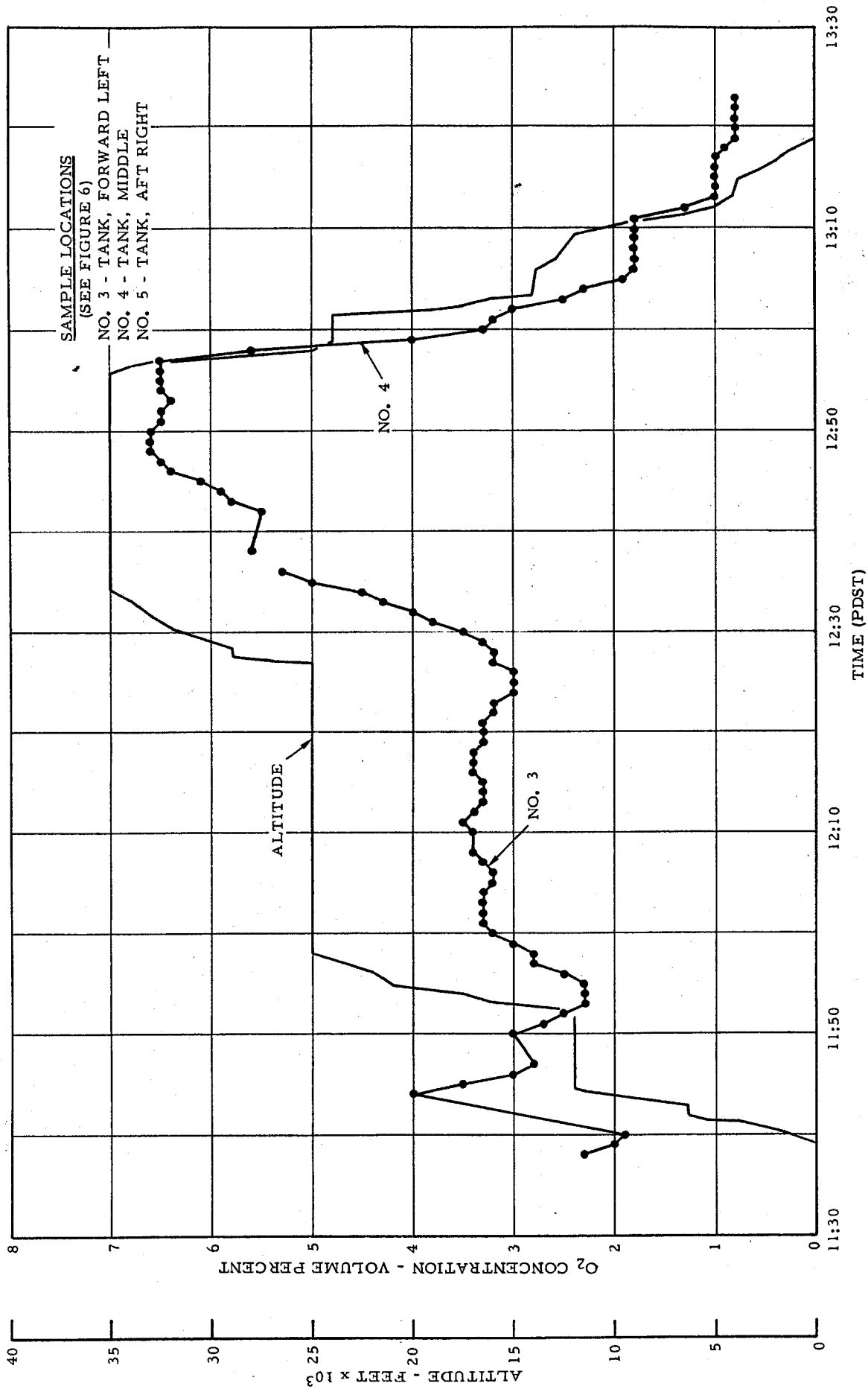

FIGURE 21 - OXYGEN CONCENTRATIONS IN CENTER FUEL TANK FOR FLIGHT 6

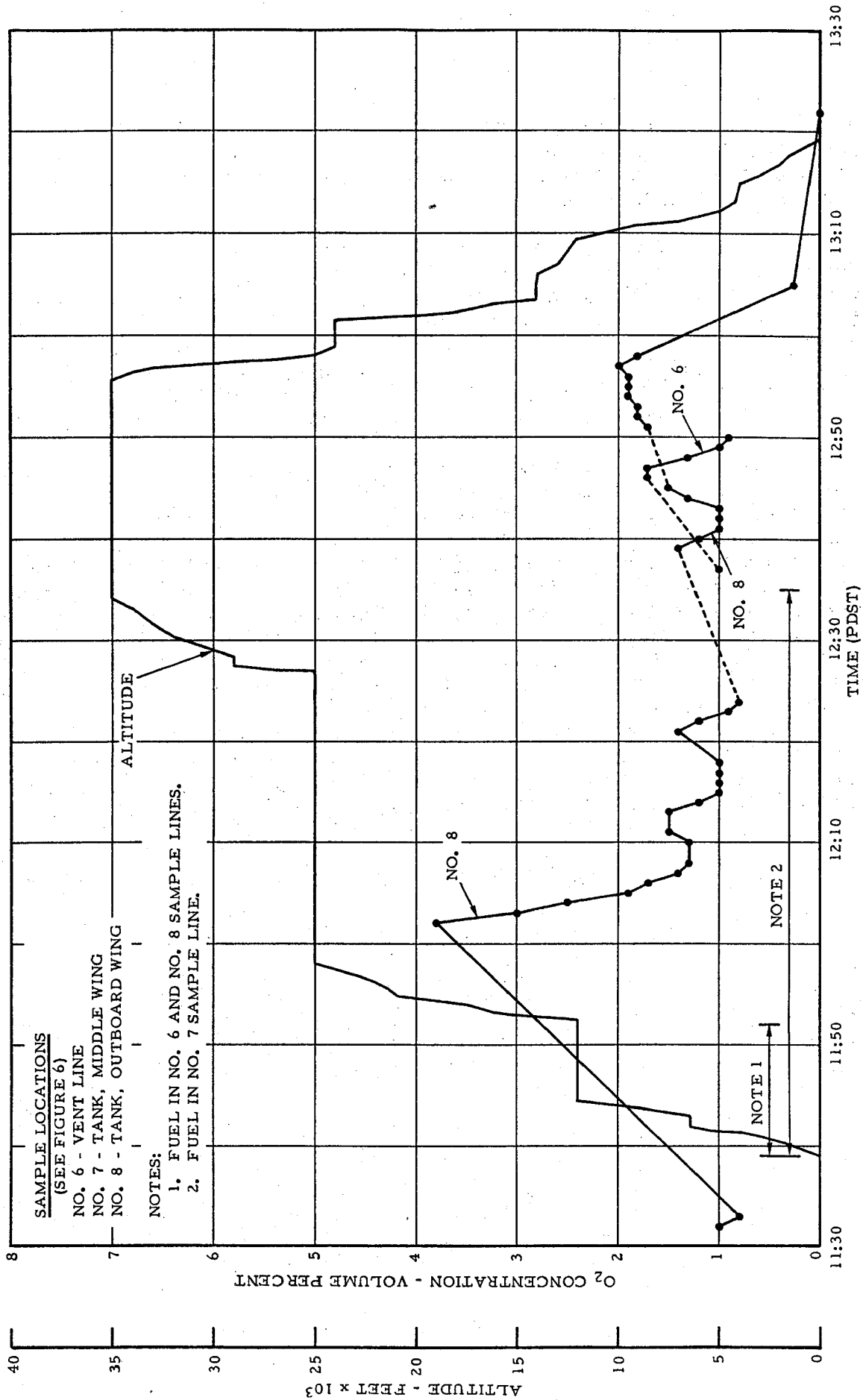

FIGURE 22 - OXYGEN CONCENTRATIONS IN RIGHT MAIN FUEL SYSTEM FOR FLIGHT 6

a high oxygen concentration during fueling and at takeoff, minimum scrubbing of fuel saturated with oxygen enriched gases, a full fuel load, and a climb-out procedure which does not activate the nitrogen pressurization subsystem.

The aircraft was fueled from an uninerted condition by fueling and defueling with the inerting system inoperative. This allowed air to enter the tanks through the dive valves as the aircraft was defueled. Prior to the flight, the aircraft was refueled and then with the inerting system operating, defueled and refueled to the normal full level. This fueling procedure resulted in a high initial oxygen concentration in the vapor spaces and a full load of fuel which had been scrubbed only once and initially with tank vapors having a relatively high oxygen concentration.

A steady climb to altitude was made without activating the nitrogen pressurization subsystem by leveling off or descending. The oxygen level in the left tank vent line increased from 1.3 to 5.3 percent (see Figure 23). The oxygen level in the vent decreased sharply after cruising at 35,000 feet for 12 minutes. Since the aircraft had neither operated on fuel from the left tank nor lost altitude, a leak in the fuel system is considered to have developed and allowed nitrogen to flow from the fog nozzle and lower the oxygen concentration in the vent and tank vapor space. This decrease in the oxygen level in the vent occurred 5 minutes after the left tank pressure had decreased from the climb valve setting to the operating pressure of the left tank regulator. The fact that the decrease in the oxygen level occurred shortly after the tank pressure decreased and started to maintain the operating pressure of the regulator is further evidence of a leak in the fuel tank or a climb/dive valve. This leak did not invalidate the critical oxygen concentration evaluation for the left tank since nitrogen first entered the tank 7 to 12 minutes after the start of the level flight at 35,000 feet, and since any additional evolution of gases from the fuel would not have raised the oxygen level significantly above the 5.3 percent.

The oxygen concentrations in the center tank during Flight 7 are shown in Figure 24. Again, the oxygen level closely followed the flight profile increasing with altitude and decreasing as fuel was consumed and as the aircraft descended. The decrease in the oxygen level during the initial climb is attributed to the slow response of the center tank oxygen sensor. The oxygen level peaked at 7.5 percent 12 minutes after reaching 35,000 feet and then during level flight decreased to 7 percent as fuel was consumed from the center tank.

The oxygen concentrations in the right fuel system vent and tank for Flight 7 are shown in Figure 25. The 3-percent reading in the vent during the climb and readings in the tank during the latter portion of the climb are considered to be high due to the slow response of the right tank oxygen sensor. The maximum oxygen concentration was 4.1 percent and was measured outboard in the right tank 29 minutes after initiating level flight at 35,000 feet.

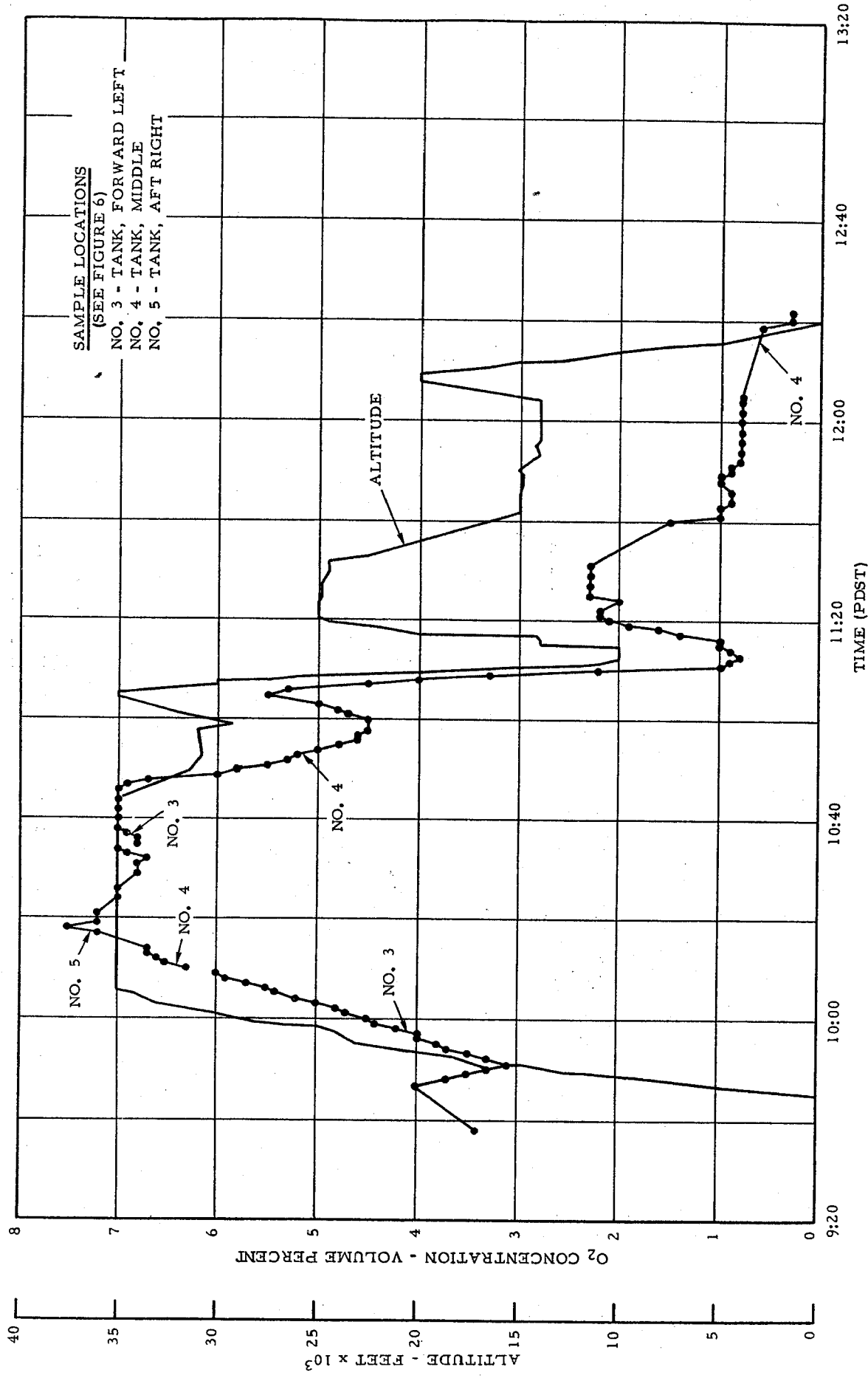

FIGURE 24 - OXYGEN CONCENTRATIONS IN CENTER FUEL TANK FOR FLIGHT 7

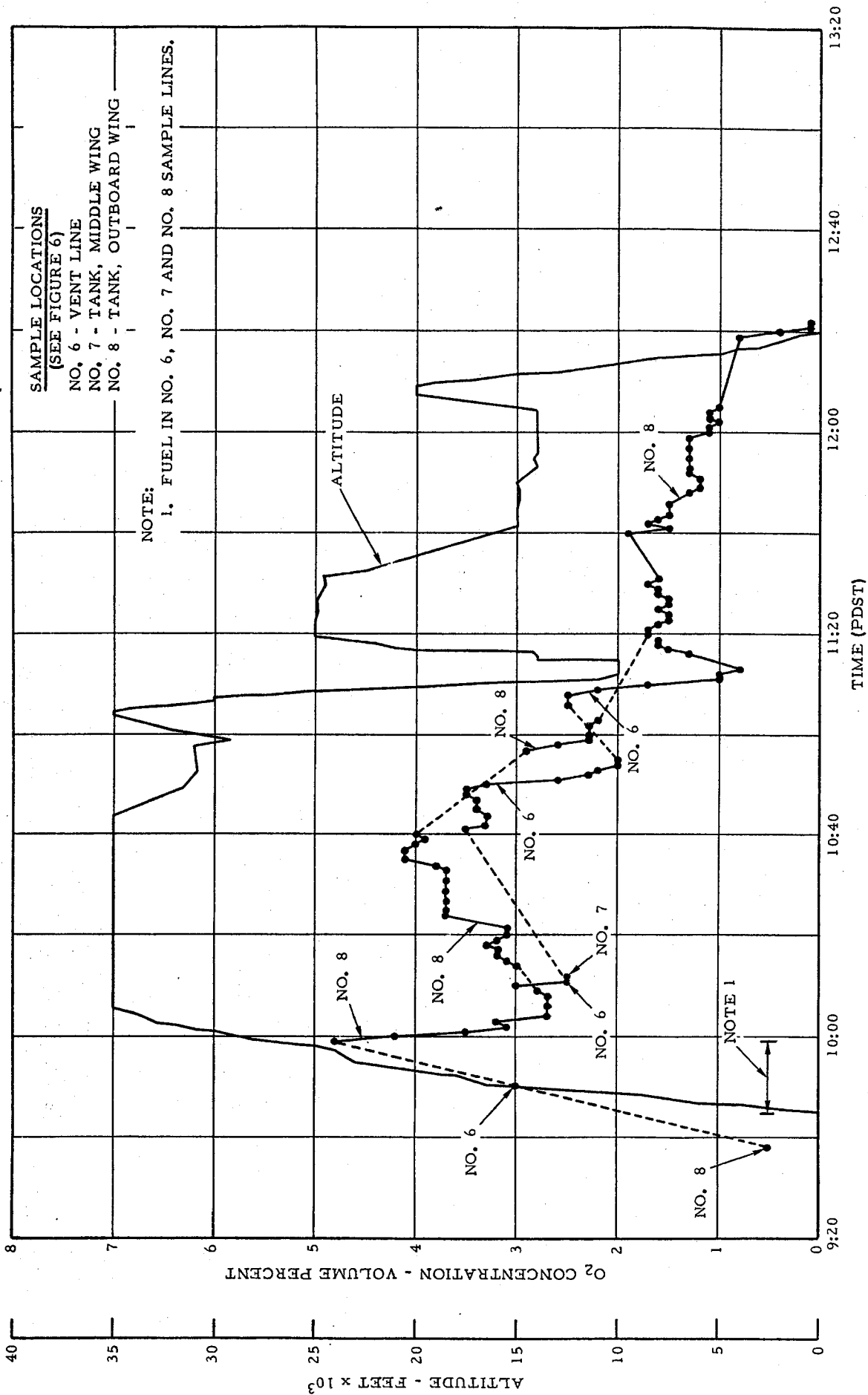

FIGURE 25 - OXYGEN CONCENTRATIONS IN RIGHT MAIN FUEL SYSTEM FOR FLIGHT 7

The oxygen level in the main tanks at the beginning of the cruise portion of Flight 7, prior to fuel being withdrawn from the main tanks, is considered to be a good indication of the expected maximum oxygen concentration in the gases dissolved in the fuel in the main tanks. Since the fuel for this flight was scrubbed only once and initially with tank vapors having a relatively high oxygen concentration, the oxygen in the fuel should have been at a maximum level. Since the initial ullage space was small relative to the volume of gases evolving from the fuel, and since the climb-out procedure did not activate the nitrogen pressurization subsystem, the amount of dilution of the gases released from the fuel in the main tanks should have been minimum at the beginning of the cruise. Therefore, based on the oxygen concentrations in the main tanks at the beginning of the cruise, the main tank oxygen level in the fuel would not normally be expected to exceed 5 1/2 percent.

Flights 8 and 9 were primarily conducted to demonstrate that the fuel tank inerting system, as modified during the flight test program, corrected the fuel venting problem, and did not adversely affect the operational capabilities of the aircraft. Flight 9 was a continuation of Flight 8 after a series of touch-and-go landings. Flight 9 was performed to check the operation of the inerting system during maximum rate climb and descent conditions with a minimum fuel load.

Figures 26 through 28 show the oxygen concentrations in the fuel system vents and tanks during Flights 8 and 9. Since the aircraft remained inerted between Flights 7 and 8 and since the oxygen-enriched gases had been released during Flight 7 from approximately 45 percent of the fuel load, the initial oxygen level was low and remained low during Flights 8 and 9.

The oxygen level in the center tank following Flight 8 was 1 percent with only 20 percent of the fuel remaining in the tank. The center tank was emptied during Flight 9 as the aircraft passed through 5,000 feet, while performing a maximum rate climb to 35,000 feet. The oxygen level at the top of the climb was approaching 4 percent in the center tank. This oxygen level is higher than would be expected under the existing test conditions for the following reasons: (1) the oxygen level at the end of Flight 8 was 1 percent and the touch-and-go landings between Flights 8 and 9 should have decreased the oxygen level; (2) the amount of gas evolved from the fuel in the center tank was minimal since the tank was emptied during the initial portion of the climb to 35,000 feet; and (3) the oxygen concentration shown in Figure 28 for the right tank vent was less than 1 percent at the top of the climb. Leakage of air into the center tank would be required in order for the oxygen level to increase from 1 to 4 percent under the conditions existing during the test. Since this apparent leakage occurred without any high rate of altitude changes or loss of tank pressure, the leakage would have had to occur between a pressurized area of the aircraft and the tank. The events occurring prior to Flight 9 and the size of the leak required to produce this increase in oxygen concentration indicate that the air entered the tank through the sample cylinder return line. A sample had been taken during Flight 8 from the center tank while at 35,000 feet. The cylinder was removed following the emergency descent to 5,000 feet and after shutting

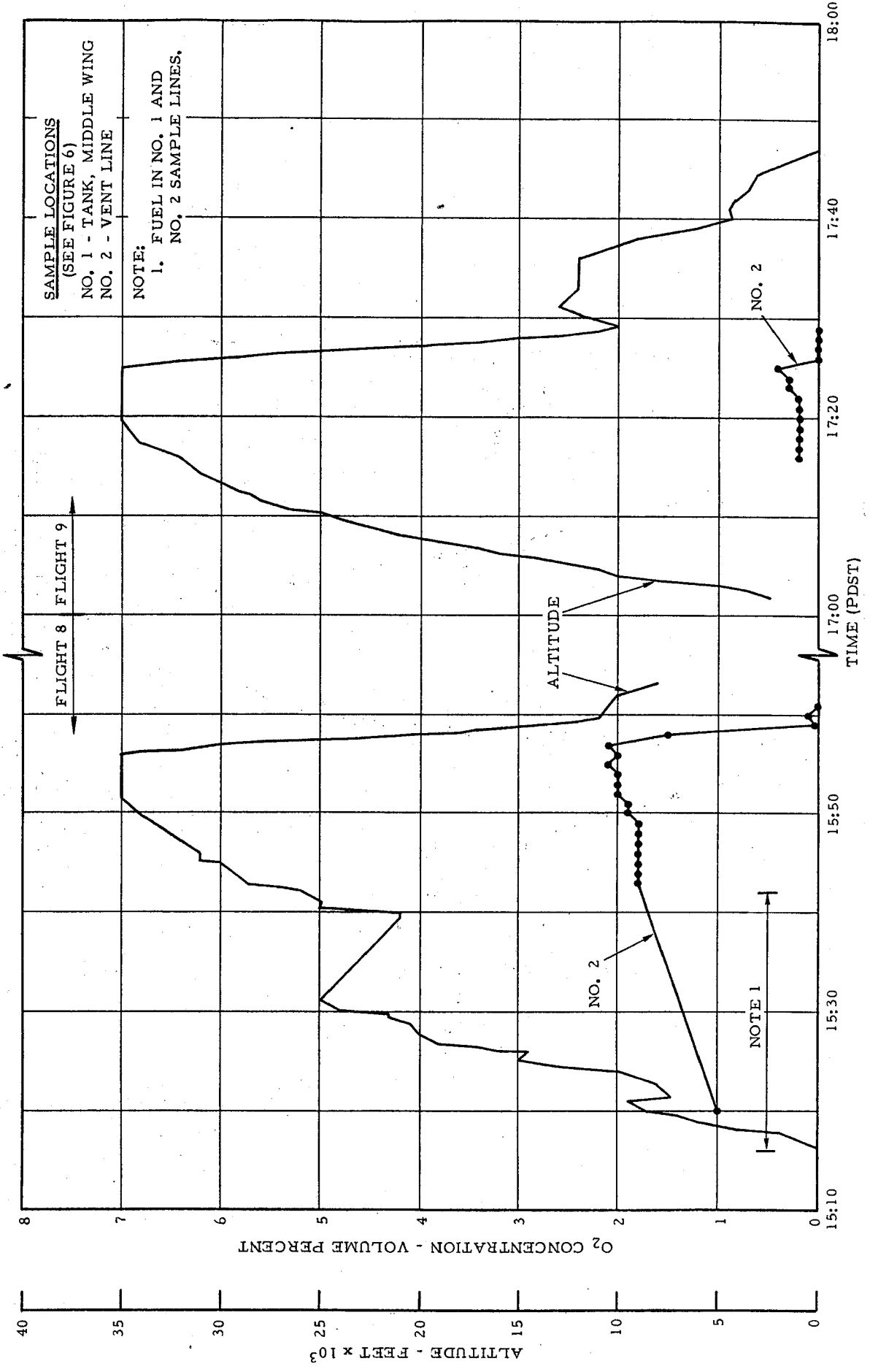

FIGURE 26 - OXYGEN CONCENTRATIONS IN LEFT MAIN FUEL SYSTEM FOR FLIGHTS 8 and 9

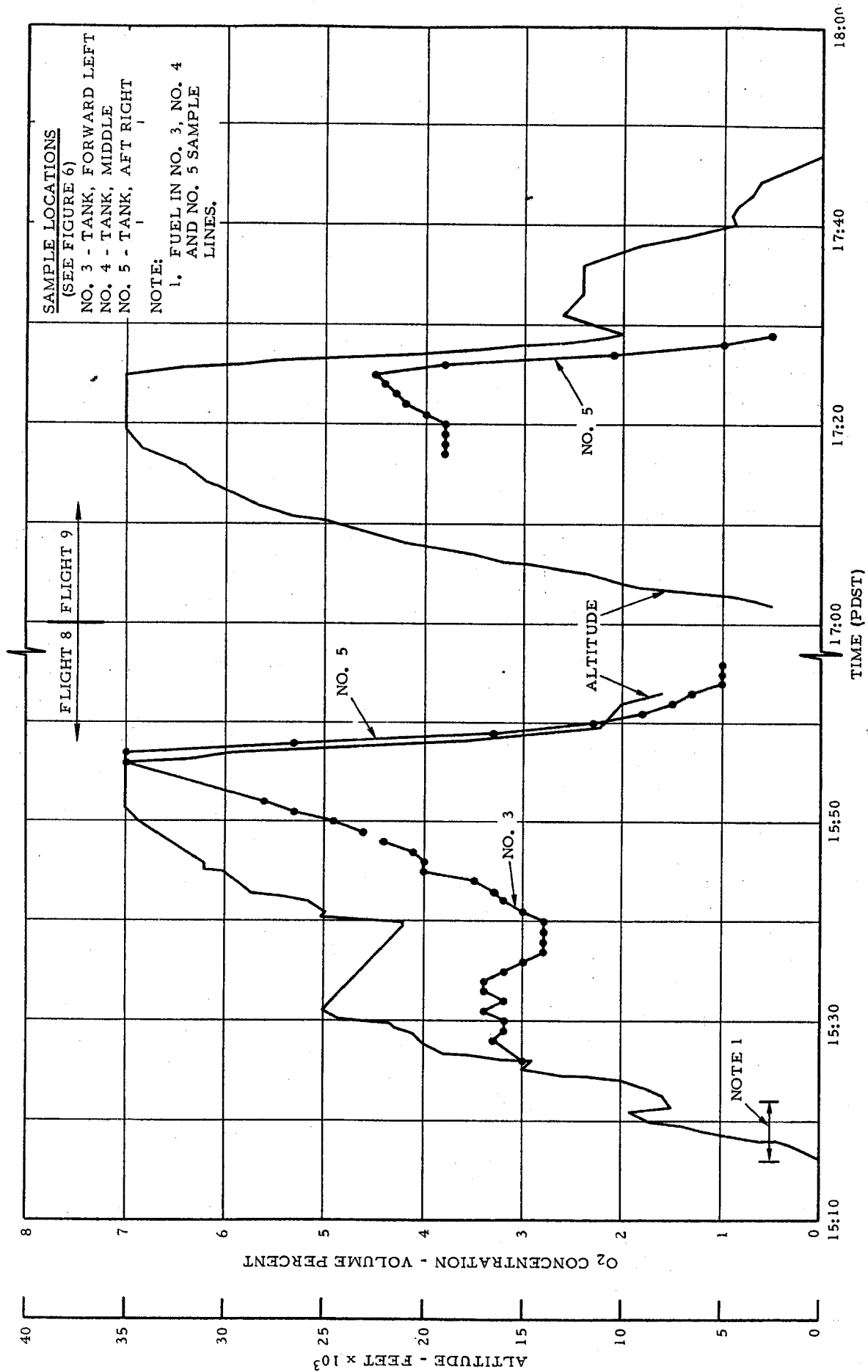

FIGURE 27 - OXYGEN CONCENTRATIONS IN CENTER FUEL TANK FOR FLIGHTS 8 and 9

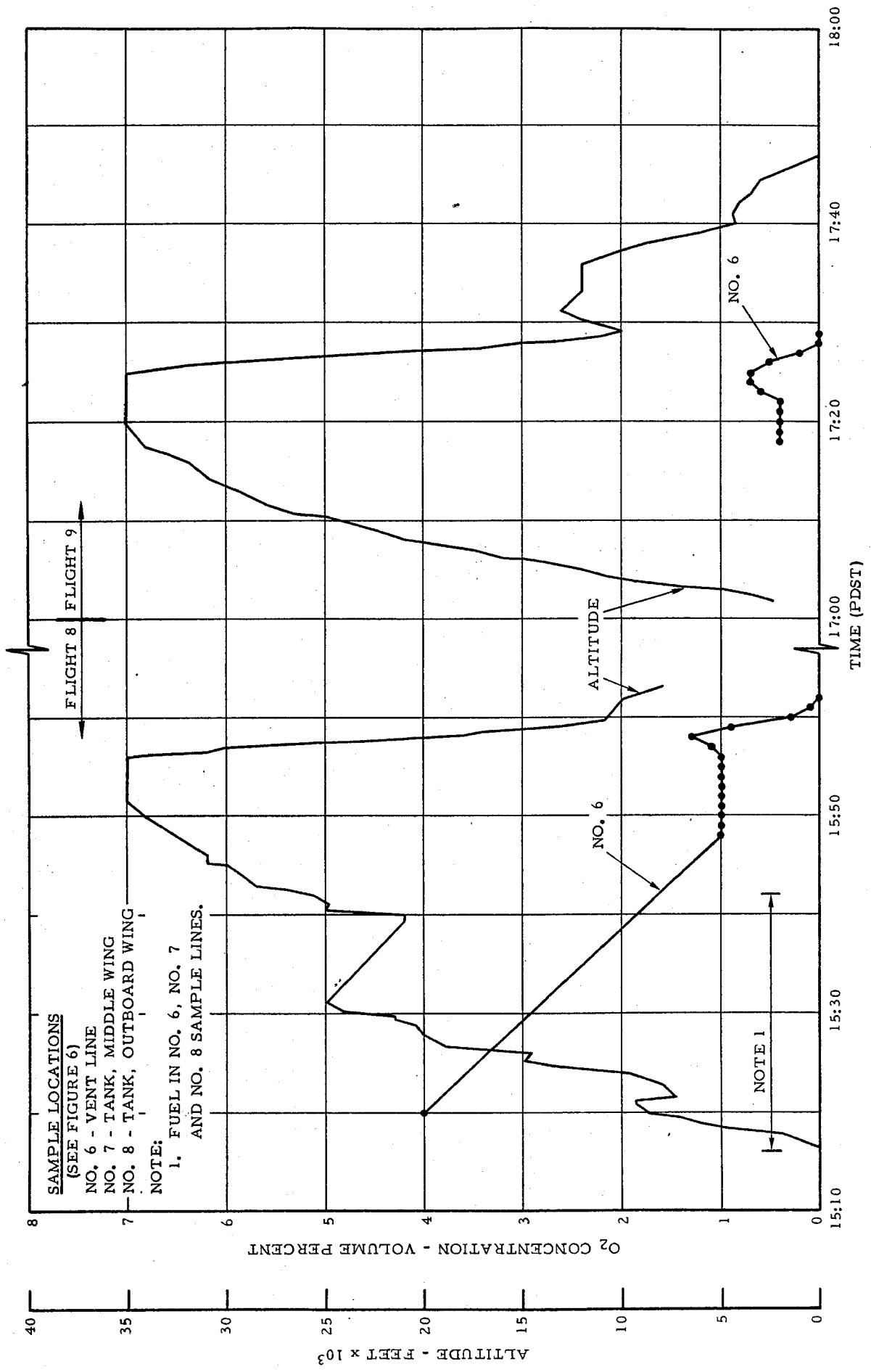

FIGURE 28 - OXYGEN CONCENTRATIONS IN RIGHT MAIN FUEL SYSTEM FOR FLIGHTS 8 and 9

down the pumps on the oxygen-sampling equipment. It is suspected that the hand-operated valve in the return line was not closed and the pressurized cabin air leaked into the center tank during the 1 hour period the pumping equipment was shutdown.

The oxygen concentration reading in the right tank vent, shown in Figure 28, during the initial climb of Flight 8, is considered to be high due to the slow response of the oxygen sensor.

The maximum rate climb during Flight 9 was conducted to determine the capability of the primary climb valves in preventing large tank differential pressures under the most demanding conditions. With minimum fuel and maximum vapor space, the volume of gas expansion is maximum during an ascent. Therefore, the maximum rate climb combined with the minimum fuel load established conditions requiring the maximum flow out of the tanks through the primary climb valves and producing maximum positive differential tank pressures. The primary climb valves were capable of venting the expanding gases overboard at a rate sufficient to maintain low tank differential pressures (0.80 psid) without opening the secondary climb valves. The pressure buildup in both tanks above the cracking pressure of the primary climb valves was only 33 percent of the required buildup to crack open the secondary climb valves.

The maximum rate descent during Flight 9 was conducted to determine the capability of the inerting system in maintaining a positive tank pressure under the most demanding conditions. With minimum fuel and maximum vapor space, the quantity of nitrogen required to maintain a positive tank pressure during a descent is maximum. Therefore, the maximum rate descent, combined with the minimum fuel load, established conditions requiring the maximum nitrogen flow rate from the pressurization subsystem. The descent rate peaked at approximately 9,700 fpm and averaged 6,700 fpm during the descent from 35,000 to 11,000 feet. A positive tank pressure was maintained in all tanks during this maximum rate descent. The minimum differential pressures recorded for the left and right tank were 0.23 and 0.34 psid, respectively, 46 percent and 68 percent of the regulator operating pressures.

The in-flight temperature environment of the fuel tanks was not substantially changed by the operation of the nitrogen pressurization subsystem. Vapor, fuel and structural temperatures near the left nitrogen pressurizing nozzle remained above 0°F during all inerted and uninerted flight tests. The minimum temperatures normally occurred while cruising at 35,000-foot altitude and were measured on the internal skin surface at the bottom of the fuel tank. The fuel temperature at the boost pump inlets decreased up to 16°F, but remained above 27°F, during high rate descents from 35,000- to 10,000-foot altitude, when normal nitrogen pressurizing flow requirements were greatest. The uninerted flights showed little or no temperature change during similar descents.

A ground test was also conducted to determine the effect of the pressurizing flow of nitrogen on the fuel tank temperature environment. A loss of tank pressure under critical conditions was simulated by manually opening the primary climb and dive valve for the left tank with the Dewar full and 1,000 pounds of fuel remaining in the left tank. The full load of nitrogen was discharged into the left tank in 32 minutes. The minimum temperature measured in the area of the pressurizing nozzle was -69°F and occurred approximately 5 minutes before the Dewar was emptied. As a result of this test, the flight manual supplement for the FAA DC-9-15 aircraft includes a requirement of turning off the fuel tank inerting system when the post-flight fuel level in either main tank is less than 1,000 pounds.

Stratification and Mixing

Further discussion of the processes occurring within the DC-9 inerted fuel tanks is considered useful in understanding the interpretation of the data relative to stratification and mixing in the gas phase.

The composition of the mixture in the ullage space of fuel tanks is frequently calculated on the bases of equilibrium conditions. The mixture is assumed to be composed of air and fuel vapor having a concentration defined by the altitude and fuel temperature. This calculation is not considered adequate for the inerted DC-9 fuel tanks. Under transient flight conditions, the oxygen concentrations in the ullage space and in the gases dissolved in the fuel and the fuel vapor concentration are dependent on too many variables to be predictable at the present time. Even with instantaneous and complete mixing assumed, the concentrations in the gas phase would be dependent on the rate of evolution and the oxygen level of the dissolved gases. The rate of evolution is controlled by the ascent rate and the fuel vibration and sloshing levels. The oxygen level of the dissolved gases is influenced by the existing conditions in the tank at the time of refueling, the dissolved gases in the fuel used to refuel the aircraft, and the efficiency of the scrubbing process. The rate and degree of mixing depends on such factors as the diffusion rates of the constituents, the temperature gradient and convection currents, the amount of venting, the vapor space volume and fuel surface area, tank baffling and the relative motion between the vapor space, the fuel and the tank.

According to the kinetic theory of gases and the principles of thermal equilibrium, a random movement of the molecules in the ullage space will cause mixing and diminish local differences in concentration of the gas mixtures with time. In a closed container without forced mixing, the molecular diffusion of gases is not an extremely fast process. The diffusion rates increases as the density of the gas decreases. The diffusion rates of oxygen and nitrogen gases are approximately the same and, due to their relatively low molecular weight, are considerably greater than the rate for fuel vapors. Therefore, the oxygen and nitrogen distribution balance would be expected to occur before the fuel vapor reaches a state of equilibrium.

The same mechanisms are involved in mixing the nitrogen and oxygen gases evolving from the fuel and the nitrogen pressurization flow, as are involved in mixing fuel vapors. Therefore, a review of recent investigations of the fuel vapor characteristics in the ullage of aircraft fuel tanks was considered to be worthwhile. However, it should first be noted that oxygen and nitrogen are perfect gases and diffuse at a higher rate and that fuel vapor near the condensation point is an imperfect gas which stratifies.

In Reference 6, Pedriani found that under static conditions the fuel vapor concentration in a tank containing liquid JP-4 fuel and air became uniform in less than 5 minutes and remained stable for long periods of time. The fuel vapor layered to some extent with the volumetric fuel concentration near the surface of the fuel being 1 to 2 percent higher than at the top of the tank. When fuel was withdrawn from the tank, the fuel vapor concentration remained stable relative to the surface of the fuel. However, the concentration at a fixed location in the tank changed significantly due to the falling fuel level and the inflow of air through the vent at the top of the tank. Differential gradients ranging from 3 to 5 percent between the concentrations at the fuel surface and the top of the tank existed at the time the tank was emptied. When the tank was subjected to a rocking motion while fuel was being withdrawn, the fuel vapor concentration again remained stable relative to the surface of the fuel. Under the rocking conditions, differential gradients ranging from 1 to 11 percent were recorded over a range of vibration frequencies and fuel temperatures.

Similar-type testing is reported in Reference 4. In addition to determining the JP-4 fuel vapor gradient in a tank as a function of fuel temperature and tank vibration, the ambient pressure was varied to simulate altitudes from sea level to 15,000 feet. The sea level test results were generally the same as those reported by Pedriani. The fuel vapor layered and moved downward as fuel was withdrawn and air entered at the top of the tank. However, at altitude the vapor concentration throughout the tank became more uniform. This was attributed to the increased motion associated with fuel evaporation and the air saturated with an equilibrium concentration of fuel vapors evolving from the liquid phase in the form of bubbles.

The tests reported in References 4 and 6 were conducted under steady state conditions. In Reference 7, fuel vapor measurements were made under the transient conditions associated with the ascent and descent portions of the flight profile. The fuel/air mixtures were found to be uniform within the entire ullage volume during the ascent and cruise portions of the flight profile. However, large fuel vapor gradients were measured during the descent with mainly air near the vent inlet. Fuel gradients were also reported during level flight for a tank configuration where the ratio of ullage volume to liquid surface area was greater than 1.5. This report further states that evaporative lag and air outgassing can cause fuel/air mixture ratios in the ullage to be different from equilibrium values, especially during ascent.

The gas phases of the DC-9 inerted fuel tanks, after the tanks were filled with scrubbed fuel, are considered to have become a homogeneous mixture in equilibrium prior to each test flight. This means that the oxygen, nitrogen, and fuel vapor in each tank was well mixed and the partial pressure of the fuel vapor was the same as the vapor pressure of the liquid fuel. With the tanks full or near full and the vent valves closed, minimal fuel vapor stratification would be expected due to the shallow depth of the ullage spaces and to the tanks and vents being sealed from atmospheric air.

As previously discussed, as the aircraft rotated and initiated a climb to altitude, the vapor spaces in the wing tanks moved inboard and forward. Each time the aircraft leveled off or performed an uncoordinated turn the vapor spaces moved and relocated. The movement of the vapor space in the center tank was similar but less severe. This movement was limited more to the forward and aft directions due to the constant height of the center tank at each fuselage station. The occasional relocation of the vapor spaces in each tank tended to minimize any local differences in concentration existing at the time.

The vent box climb valves opened during the initial climb and a large portion of the preflight mixture was vented overboard. The remaining portion was diluted as the gases dissolved in the fuel came out of solution. At the same time, waves were generated by the vibration and sloshing characteristics associated with fuel tanks during dynamic flight conditions, and a mist developed in the ullage space. The decreasing pressure during the climb more than offset the effects of decreasing temperature and allowed additional fuel to vaporize. The concentrations in the ullage spaces would therefore not be expected to remain in an equilibrium state during the climb because of the many transients present. The instantaneous concentrations would be expected to lag the equilibrium values. The concentration of fuel vapor at the surface of the fuel would be expected to be relatively high. Likewise, the oxygen and nitrogen concentrations near the surface of the fuel would be at approximately the same level as the dissolved gases in the fuel.

As the aircraft levels off and maintains a constant altitude, the ullage mixtures would tend to be homogenous since the gases would no longer evolve from the fuel or evolve at a much slower rate and fuel vaporization would decrease. Fuel consumption from a tank would upset this balance to some degree, as the flow of nitrogen diffused through the tank to replace the fuel withdrawn. Under cruise conditions, with fuel consumption from the center tank, the lowest oxygen concentrations would be expected to occur in the right wing near the fuel surface and in the center tank near the vent line opening. Likewise, with fuel being withdrawn from the wing tanks during cruise flight, the lowest oxygen concentrations would be expected to occur near the fuel surface of each wing tank.

Conditions in the tanks similar to those existing during cruise would be expected to occur during descents. The major difference would be the rate and magnitude of the change produced by the higher nitrogen flow during descents.

As discussed previously, the critical conditions for maximum oxygen concentration occur shortly after leveling off following a climb. These conditions are conducive to mixing the ullage of all three DC-9 fuel tanks. A forced mixing action occurred during the climb as a result of fuel evaporation, gas evolution, and the wave motion of the fuel and at the end of the climb as a result of the vapor spaces relocating. Flights in which fuel is withdrawn only from the center tank during the climb are also conducive to more complete mixing in the ullage space of the wing tanks. The center tank would therefore not be expected to be as well mixed as the wing tanks due to the large ullage volume relative to the surface area of the fuel and to the more limited movement of the ullage space. The oxygen concentration measurements in the center tank, as the sampling was switched from one location to another, did not show any significant changes during any of the flight tests. This is particularly evident in Figures 15 and 24 for Flights 3 and 7. Since the oxygen concentration did not vary with location in the center tank and the relative position of the probes above the fuel surface changed with aircraft attitude, the center tank is considered to have been well mixed. The wing tanks are also considered to have been well mixed during steady climb and critical conditions for peak oxygen concentrations at the beginning of the cruise, since under these conditions, there is no flow of nitrogen and mixing in the ullage spaces of the wing tanks should have been more complete than in the center tank. This was substantiated by the oxygen concentration measurements taken in the right main tank during Flights 3 and 7, Figures 16 and 25. The differences in the oxygen concentrations between the two widely separated probes in the right tank was less than 1/2 percent during the initial cruise portions of these flights.

Oxygen Sampling Requirements

As discussed in the preceding section of this report, the DC-9 test results and tests reported in Reference 7 have shown that the ullage space of a fuel tank is well stirred by the dynamic flight conditions associated with a climb to altitude as long as air and nitrogen are not entering the tank at the time. The DC-9 flight tests also showed that with the inerting system operating properly, the peak oxygen concentration occurs at the beginning of the cruise and under well-stirred ullage space conditions. Mixing under these conditions occurs within the boundaries of each vapor space, even where two vapor spaces are interconnected through the vent system. Therefore, to properly evaluate the performance of a fuel tank inerting system, the oxygen concentration in each enclosed vapor space should be measured under critical flight conditions. In-flight sampling from vapor spaces which are clearly not critical from the standpoint of peak oxygen levels would not be required to properly evaluate the performance of the inerting system in maintaining an explosion safe mixture. However, sampling from each enclosed vapor space is considered to be valuable in evaluating the overall system performance and efficiency.

In-flight sampling from the vent systems is not required during climb and cruise since air leakage into the tank is not likely and rises in oxygen levels due to the evolved gases would be better sensed in the fuel tanks. However, in-flight sampling of each vent system between the climb and dive valves and the tank opening is required due to the relatively small volume of the vent systems to assure that the amount of air leakage at the vent valves is not sufficient to produce an explosive mixture in the vents during a descent.

In-flight sampling from the fuel tanks may not be required to determine the effectiveness of a DC-9 or similar type inerting system which lowers the oxygen concentration in the gases dissolved in the fuel and has a normally closed vent system. Direct measurements of the oxygen concentrations of the dissolved gases and in the tank ullage spaces prior to the flight may be all that is required. If these readings are all below the level required for combustion, then the tank will remain inert throughout the flight unless air enters from outside the tank. The dive and climb valves in each vent system are intended to prevent this. Therefore, by measuring the oxygen level in the ullage spaces and in the dissolved gases during ground tests and the oxygen level in the vents during flight tests, the effectiveness of an inerting system with preflight fuel scrubbing, in maintaining an explosion safe mixture may be evaluated without in-flight sampling from the tanks.

SUMMARY OF RESULTS

The significant findings resulting from the development and evaluation of a nitrogen fuel tank inerting system for the DC-9 aircraft are as follows:

1. The maximum oxygen concentration in the fuel tank ullage occurred shortly after reaching cruise altitude. Peak volumetric oxygen concentrations of 5.3, 7.5, and 4.1 percent were measured under critical conditions in the left, center, and right fuel tanks, respectively.

2. The oxygen concentrations in the inerted fuel tank ullages generally followed the flight profile of the aircraft. The oxygen level increased during the climb as the gases evolved from the fuel, gradually decreased during cruise as fuel was withdrawn, and decreased sharply during descent as the flow of nitrogen maintained a positive tank pressure.

3. The oxygen concentration in the center tank was greater than in either wing tank. Under critical conditions, the oxygen concentration in the center tank was 2 and 3 1/2 percent greater than the left and right wing tanks, respectively.

4. The release of oxygen-rich gases dissolved in the fuel during the ascent increased the volumetric oxygen concentration in the ullage of an uninerted fuel tank from 21 to 25 percent.

5. The oxygen concentration in the gases dissolved in the scrubbed fuel in the main tanks was less than 5 1/2 percent by volume as indicated by the analysis of the evolved gases.

6. The ullage of each fuel tank was analytically determined to have been well mixed during steady ascent and beginning of cruise flight. Different mixtures existed between tanks connected by a common vent system. The mixtures lagged the equilibrium concentrations during the climb due to the many transient conditions present.

7. The oxygen concentration in the left tank vent line increased from 1 to 17 percent during Flight 6 while cruising at 35,000 feet with both engines operating on fuel from the left main tank. This resulted from a high differential tank pressure during the ascent having caused the pressure limiter to close the isolation valve and shutoff the nitrogen supply to the tanks. The priority valve directed the higher right tank pressure to the limiter as fuel consumption decreased the left tank pressure. Since the pressure decreased, the isolation valve remained closed as the left tank pressure became negative and the dive valve opened and admitted air into the vent system. The reoccurrence of this condition was prevented by increasing the pressure limiter settings so that the isolation valve opened at a pressure above the operating ranges of the regulator and the primary climb valves.

8. The in-flight temperature environment of the fuel tanks was not substantially changed by the operation of the nitrogen pressurization subsystem. Vapor, fuel and structural temperatures near the left nitrogen pressurizing nozzle remained above 0°F during all the inerted and uninerted flight tests.

9. Fuel leakage from both vent box outlets was observed during the initial inerted flights with full fuel loads. Replacing and relocating leaking float-type vent drain valves with spring-loaded flapper-type valves and relocating the inlet to the primary climb and dive valve assemblies, eliminate the loss of fuel with the tanks filled to the normal full level and substantially decreased the amount of fuel being vented overboard with the tank expansion spaces filled.

10. Leakage of the vent system climb and dive valves was noted during the flight test program. This leakage increased the flow of nitrogen from the pressurization subsystem, lowered the oxygen level in the tank ullage, caused a vent flow which forced fuel from the vent lines into the vent boxes and thereby increased fuel venting.

11. The primary climb valves vented the expanding gases overboard at a rate sufficient to maintain low tank differential pressures under the most demanding ascent conditions without opening the secondary climb valves.

12. The nitrogen pressurization subsystem maintained a positive tank pressure under the most demanding descent conditions.

13. The response characteristics of the in-flight oxygen analyzer system deteriorated with accumulated operating time without rejuvenating the sensors.

CONCLUSIONS

Based on the results of the development and evaluation of a nitrogen fuel tank inerting system for the DC-9 aircraft, it is concluded that:

1. The nitrogen inerting system is effective in maintaining a mixture in the fuel system vents and tank vapor spaces having a volumetric oxygen concentration less than 8 percent under all normal and emergency flight conditions and without producing excessive tank pressure differentials.
2. The primary climb valves have the capability of and are more than adequate in venting the expanding gases overboard under the most demanding ascent conditions.
3. The nitrogen pressurization subsystem has the capability of and is more than adequate in maintaining a positive tank pressure under the most demanding descent conditions.
4. The oxygen concentration in the uninerted fuel tank ullage was substantially lower than the 32-percent theoretical value at the top of a climb due to the dilution of the evolved oxygen-rich gases with the air initially in the tank and air entering the tank as fuel was withdrawn prior to takeoff and during level flight.
5. Raising the level of the scrub float valves in the main fuel tanks and decreasing the amount of climb and dive valve leakage would increase the system efficiency without exceeding the allowable oxygen concentration.
6. An inerting system which pressurizes the fuel tanks changes the fuel tank vent system design requirements in order to prevent fuel spillage from the vent outlets.
7. In order to evaluate a fuel tank inerting system, minimum sampling requirements would normally consist of oxygen concentration measurements in each enclosed vapor space under critical fueling and flight conditions and in each vent system under all flight conditions.
8. The ullage of fuel tanks designed so that vapors are neither trapped nor restricted from moving along the upper surface of the tank, are well mixed under all flight conditions except conditions which allow air or nitrogen to enter the tanks.
9. The FAA in-flight oxygen analyzer equipment and the measurement techniques developed are capable of providing the oxygen concentration information necessary to evaluate the performance of installed fuel tank inerting system.

REFERENCES

1. S. V. Zinn, "Inerted Fuel Tank Oxygen Concentration Requirements," Federal Aviation Administration, Interim Report FAA-RD-71-42, August 1971.
2. "Solution and Evolution of Gases and Vapors in Aircraft Fuel," WADC Technical Report 59-193, Coordination Research Council, April 1959.
3. B. F. A. Gatward and H. W. G. Wyeth, "The Effect of Air Evolution from Fuel on the Inert Gas Protection of Aircraft Fuel Tanks," Royal Aircraft Establishment, Technical Note No. M. E. 96, October 1951.
4. T. C. Kosvic, H. L. Helgeson, and B. P. Breen, "Flight Vibration and Environmental Effects on Formation of Combustible Mixtures within Aircraft Fuel Tanks," USAAVLABS Technical Report 70-43, Dynamic Science, September 1970.
5. B. A. Faulkner and E. C. G. Jelfs, "Release of Vapour and Air from Aviation Gas Turbine Fuels," Esso European Laboratories Report No. EEL-5T-50, 1950.
6. C. M. Pedriani, "A Study of the Fuel/Air Vapor Characteristics in the Ullage of Aircraft Fuel Tanks," USAAVLABS Technical Note 3, AD873252, June 1970.
7. T. C. Kosvic, L. B. Zung, and M. Gerstein, "Analysis of Aircraft Fuel Tank Fire and Explosion Hazards," WPAFB Technical Report AFAPL-TR-71-7, Dynamic Science, March 1971.